



SCC1000TB

Telescopic Boom Crawler Crane 100 Tons Lifting Capacity

Quality Changes the World



Max. lifting moment: 378t·m
Max. boom length: 59m
Max. boom+jib length: 59m+17.5m

The parameters, pictures and standard/optional equipment are only for reference in this brochure, the actual machine is based on the effective price list and contract.

■ www.sanygroup.com



Telescopic Boom Crawler Crane
SCC1000TB

P03

Main characteristics

- Upperworks
- Lowerworks
- Operation Equipment
- Safety Device

P08

Technical parameters

- Major Performance & Specifications
- Outline Dimension
- Transport Dimension
- Transport Plan

P16

Cofigurations

- Working range of H
- Load Chart of H
- Load Chart of FJ



SCC1000TB
TELESCOPIC BOOM CRAWLER CRANE
100 TONS LIFTING CAPACITY

QUALITY CHANGES THE WORLD

Main Characteristics

- Page 04 Upperworks
- Page 06 Lowerworks
- Page 06 Operation equipment
- Page 07 Safety Devices



Product Specification



Engine

- Model: 6HK1XKJC-01 diesel engine;
- Type: four-stroke, water cooling, vertical 6-cylinder, direct injection, turbo supercharging, inter-cooling, Meet Off-highway Emission Regulation of Europe (Tier III), and comply with Off-highway Emission Regulation of China (Tier III);
- Displacement: 7.79L;
- Rated power: 212kW/2000rpm;
- Maximum torque: 1080N · m/1500rpm;
- Starting device: 24V-5.0kW;
- Radiator: aluminium sheet fin type radiator core;
- Air filter: dry type air filter system, fitted with main filter element, safety filter element and resistance indicator;
- Hand throttle: rotary type hand throttle, electrically controlled;
- Fuel filter: replaceable paper filter element;
- Batter: two 12Vx165Ah capacity batteries, connected in series;
- Fuel tank: 400L.

Electrical Control System

- Adopt SYIC-II integrated control system independently researched and developed by Sany. This system is featured by high integration level, accurate operation and reliable quality;
- Control system: composed of power system, engine system, main control system, Load Moment Limiter, auxiliary system and safety monitoring system. Data communication among controller, display and engine is conducted by CAN bus technology;
- Display: It can display the engine rotating speed, fuel volume, engine oil pressure, servo pressure, wind speed, engine working time, load weight, boom angle and other working parameters and working conditions.

Hydraulic System

- Main pump: adopt open piston pump with large variable displacement;
- Gear pump: dual gear pump for swing, heat radiating and servo;
- Control: the main piston pump of variable displacement, winch piston motor of limitless variable displacement, control system of hydraulic positive flow;
- Way of cooling: heat exchanger, fan core and multi-stage cooling;
- Filter: large flow, high accuracy filter, with bypass valve and indicator, which can remind the user to replace the filter element in time;
- Max. pressure of system:
Main load, aux. load, and travel system: 32MPa;
Boom hoist cylinder lifting: 32MPa;
Swing system: 24MPa;
Control system: 4.5MPa.
- Hydraulic oil tank capacity: 950L.

Main and aux. load hoist mechanism

- Pump and motor: dual-placement speed controlled energy-efficient, combination of winch balance valve and anti-hook sliding technology, lifting or lowering the load steadily;
- Winch brake adopts concealed, normally closed, wet type and spring loaded fin type normally engaged brake, spring force braking, oil pressure released;
- Branded anti-self-rotating high-strength steel rope;
- Main and aux. load hoist winches adopt piston motor of fixed displacement to drive planetary reducer.

Main lifting mechanism	Rope speed (outermost layer)	0~130m/min
	Diameter of wire rope	Φ22mm
	Overall length of wire rope	280m
	Rated tensile force of single rope	10.5t
Auxiliary lifting mechanism	Rope speed (outermost layer)	0~130m/min
	Diameter of wire rope	Φ22mm
	Overall length of wire rope	190m
	Rated tensile force of single rope	10.5t

Boom hoist mechanism

- Double acting single piston rod hydraulic cylinder, fitted with safety balance valve, luffing angle: 0°~80°, adopting dead-weight luffing system to reduce the energy consumption and improve the steadiness of luffing operation.

Swing mechanism

- Swing brake adopts concealed, normally closed, wet type and spring loaded fin type normally engaged brake, spring force braking oil pressure released;
- With integrated cushion valve, the swing system has free slip function to realize steady swing start and control, showing outstanding microinching performance;
- Unique swing cushion design ensures more stable braking;
- Swing drive: external gearing swing drive, capable of conducting 360° rotation, maximum rotation speed 1.6r/min;
- Branded motor reducer, more reliable;
- Swing lockout: locking device, to ensure that the superstructure can be locked in front and rear directions conveniently and reliably during off-work time and transportation;
- Swing bearing: single row ball type bearing.



Product Specification

Counterweight

- The easily self-assembled and self-disassembled counterweights facilitate transport;
- The counterweights and trays pile up, conducting easy assembly, disassembly, and transport;
- Rear counterweight: Total weight: 32t, performing self-assemble and self-disassemble function;
- Carbody counterweight: fitted at front and rear of carbody, 3t*2.

Superstructure

- High strength steel welding frame structure, no torsional deformation, reasonable component layout, and convenient maintenance service.

Cab and Control

- Novelty in cab design, artistic modeling and trim and large area glass window; fitted with low beam headlamp and rearview mirror to broaden horizon; installed with air conditioner and radio; the arrangement of seats, control handle and various control buttons is ergonomically designed to enable more conformable operation;
- Cab layout: Integrated touch screen of 10.4 inch, programmable smart buttons vibration handles are offered as optional and man-machine interaction interface are more perfect;
- Armrest box: operation handle, electrical switch, emergency stop switch and ignition switch are installed on the left and right armrest boxes. The armrest box can be adjusted with the seat;
- Seat: suspension type multi-mode multi-level regulated seat, fitted with unloading switch;
- Air conditioner: cooling and heating air, optimized air passage and air port;
- Multiple cameras can be presented on the monitor at the same time to realize real-time monitoring of wire rope on each winch, conditions behind the counterweight and surrounding the machine.

Traveling drive

- Independent traveling drive device is adopted for each side of crawler frame, so as to realize straight travel, turning through reducer and drive wheel by travel motor;
- Traveling speed: The traveling can be switched between high speed and low speed, and the high speed can be up to 1.65km/h;
- Gradeability: 40%.

Traveling braking

- Concealed wet type and spring loaded fin type normally engaged brake, spring force braking, oil pressure released.

Telescopic crawler

- Pressure of 32MPa by aux. system pushes the cylinder to realize the extension and retracting of the crawlers. The crawlers are extended at work and retracted for transport with the whole basic machine.

Crawler tensioning

- The Jack pushes the guiding wheel and insert shims to adjust the crawler tension.

Steering system

- It can realize single track turning and pivot turning.

Track shoe

- High-strength alloy milled steel prolongs the service life of track shoes. Width 850mm, Qty 54*2.

Track roller

- Maintenance-free track roller.

Outrigger

- Outrigger cylinder is offered to facilitate the track frame disassembly during jobsite transfer.

Product Specification



Main boom

- The boom is made of high-strength steel structure with U-shape section area, with six sections, of which the basic boom is 12.8m and the max. boom length is 59m;
- Full power with single cylinder and plug for telescoping.

Fixed jib

- Two fixed jib length of 10.2m and 17.5m;
- Installation angle includes 0°, 15° and 30°.

Boom tip pulley

- Welding structure, connected with the boom through pin, and used for auxiliary hook operation.

Lifting hook

Name	Capacity (t)	Pulley block	Weight (t)	Quantity
1	100	5	1.22	1
2	12.5	1	0.3	1

Note: the above-mentioned operating equipment is full-up configuration. The actual configurations are subject to contract.

Safety Device



Smart Integrated Load Moment Indicator

- The integrated LMI system is provided as standard offering to realize calibration-free and high safety and efficiency for equipment control to realize calibration-free and high safety and efficiency for equipment control;
- Based on lifting mechanics modes, the LMI computing system enables the loading precision, by no-loading calibration, to 0-10% and protects loading operation all-around; The system alarms once over-loaded to ensure safety;
- The LMI system can automatically detect the suspended load weight, working radius of the crane and the angle of boom, and compare rated load weight and actual load, working radius and boom angle. Under normal operation condition, it can intelligently judge and automatically cut off the crane action in dangerous direction, and have black box function to record the overload information;
- Its main components include: monitor, controller, length and angle sensor, pressure sensor, etc.

Assembly/working mode switching switch

- In Assembly Mode, certain safety devices are disabled to facilitate crane assembly;
- In Work Mode, all safety limiting devices activate to protect the operation.

Emergency Stop

- In emergency situation, this button is pressed down to cut off the power supply of the whole machine and all actions stop.

Over-hoist Protection of the Main/Auxiliary Load Hoist

- Height limiter is equipped on the boom/jib tip, which prevents the hook lifting up too much. When the hook is lifted up to the limit height, the limit switch activates, alarm pops up on the monitor, buzzer on the right front control panel sends alarm, failure indicator light starts to flash and the hook hoisting action is cut off automatically.

Over-release Protection of the Main/Auxiliary Load Hoist

- Three-wrap protector is installed on main and aux. load hoist to prevent over-release of wire rope. When the rope is paid out close to the last three wraps, the limit switch acts, and the system sends alarm through buzzer and show the alarm on the monitor, automatically cutting off the winch action.



Safety Device

Function Lock

- If the function lock level is not in work position, all the other handles won't work, which prevents any mis-operation caused by accidental hitting.

Slewing Lock

- Mechanical lock by pulling the pin, will lock the upperworks at the front part and the rear.

Hook Latch

- The lifting hook is installed with a baffle plate to prevent wire rope from falling off.

GPS Monitoring System

- Standard remote monitoring system: It can provide functions like GPS locating, GPRS data transfer, machine status inquiry and statistics, operating data monitoring and analysis, and remote diagnosis of failures.

Tri-color Load Indicator

- The load indicator light has three colors, i.e., green, yellow and red; and the real time load status is presented on the display. When the actual load is smaller than 90% of rated load, the green light is on; when the actual load is larger than 90% and smaller than 100%, the yellow light is on, the alarm light flashes and sends out intermittent sirens; when the actual load reaches 100% of rated load, the red light is on, the alarm light flashes and sends out continuous sirens. When the actual load reaches 102%, the system will automatically cut off the crane's dangerous operation.

Flash Alarm

- When the LMI is powered on, the flash alarm will turn on.

Swing Indicator Light

- The swing indicator light flashes during traveling or swing.

Seat Interlock

- If the operator leaves the seat, all control handles and switches will be disabled immediately to prevent any mis-operation due to accidental collision.

Illuminating Light

- The machine is equipped with short-beam light in front of machine, lamps in operator's cab and lighting devices for night operation, as well as boom lights, so as to increase the visibility during work.

Rearview Mirror

- It is installed at the front of the operator's cab, at the right handrail of the platform and near the winches.

Level Indicator

- Electrical level indicator can show the inclination angle of superstructure on the monitor.

Closed Circuit Monitoring System

- There are two cameras and illuminating lights on the tail of rotating bed, which can show the rear part and winches working on the machine.

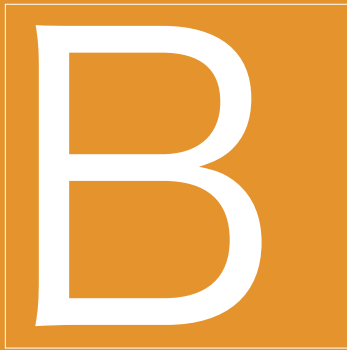

SCC1000TB
TELESCOPIC BOOM CRAWLER CRANE
100 TONS LIFTING CAPACITY

QUALITY CHANGES THE WORLD

Technical Parameters

- Page 09 Major Performance & Specifications
- Page 10 Outline Dimension
- Page 11 Transport Dimension
- Page 14 Transport Plan

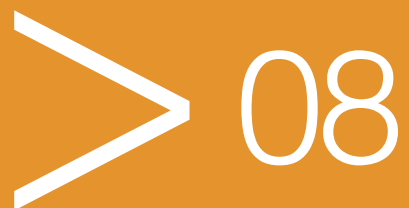

Major Performance & Specifications

Major Performance & Specifications of SCC1000TB			
Specification		Unit	Parameter
Outline dimension	Full length of the whole crane	mm	16230
	Width of the whole machine (retracted)	mm	5250(3490)
	Height of the whole machine	mm	3630
	Center distance of driving and engaged wheels	mm	5785
	Width of track shoe	mm	850
H (main boom) configuration	Maximum rated lifting weight	t	100
	Main boom length	m	12.8~59
	Main boom angle	°	0~80
	Maximum rated lifting moment	t·m	378
FJ(fixed jib) configuration	Longest main boom + longest jib	m	59+17.5
	Included angle between main boom and jib	°	0°, 15°, 30°
Working speed	Main/aux. load hoist rope speed	m/min	0~130
	Time to fully boom up/down	s	80/110
	Time to fully extend/retract boom	s	480/480
	Slewing speed	rpm	0~1.6
	No-load traveling speed	km/h	0~1.65
Engine	Model	/	6HK1XKJC-01
	Rated power/speed	kW/rpm	212/2000
Wire rope	Diameter	mm	Φ22
Transportation parameters	Weight of the whole machine	t	105
	Maximum weight of single piece transportation	t	44.5(remove main and aux. hook)
	Transportation dimension (long x width x height)	mm	16230×3000×3300
Other Parameters	Average ground bearing pressure	MPa	0.1
	Min. swing radius	mm	5156

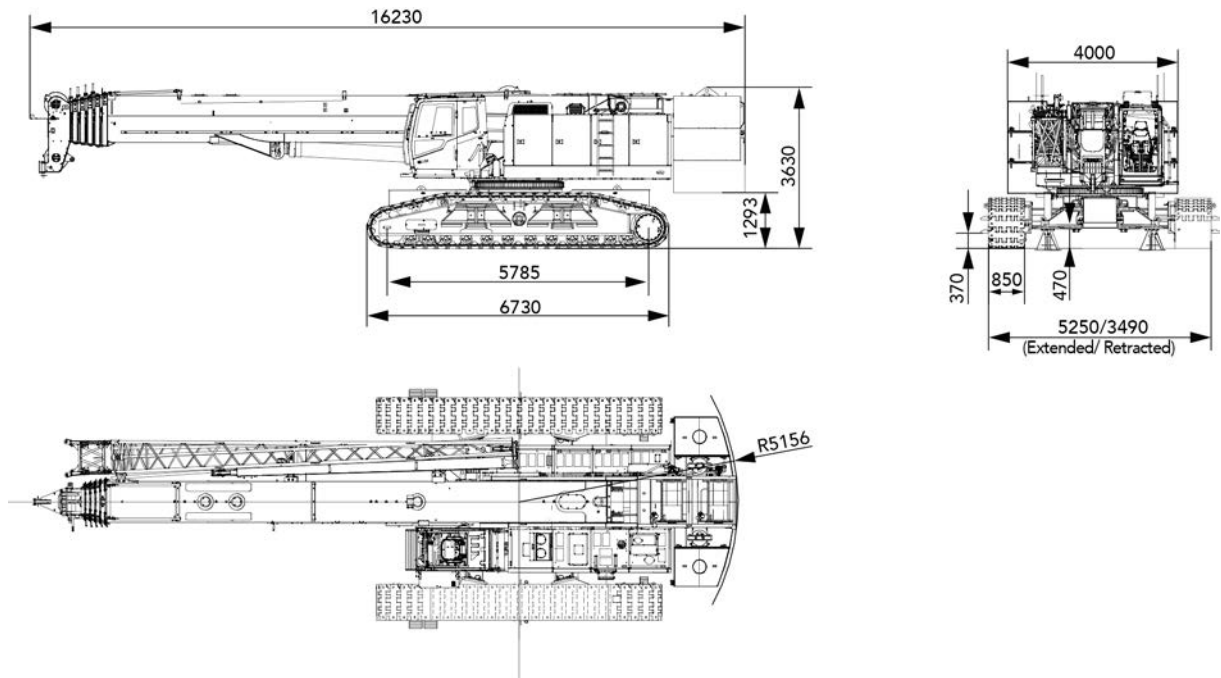
Outline Dimension

Transport Dimension

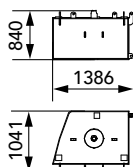
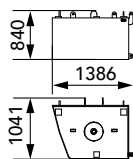
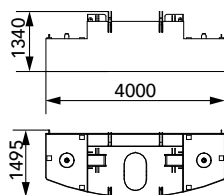
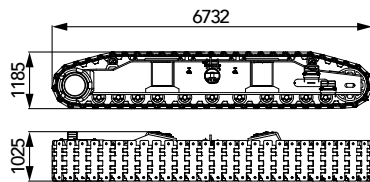
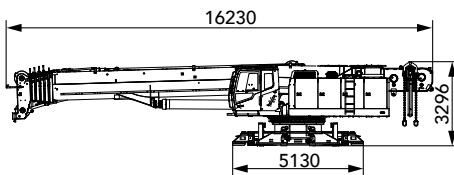
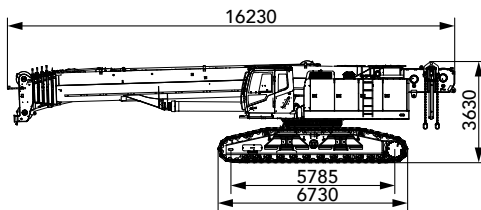

Whole Machine ×1

Length (L)	16.23m
Width (W)	3.49m
Height (H)	3.63m
Weight	65.5t

Basic Machine (with jib) ×1

Length (L)	16.23m
Width (W)	3.00m
Height (H)	3.30m
Weight	44.5t

Crawler ×2

Length (L)	6.73m
Width (W)	1.03m
Height (H)	1.19m
Weight	10.2t

Counterweight Tray 1 ×1

Length (L)	4.00m
Width (W)	1.50m
Height (H)	1.34m
Weight	18.0t

Rear Counterweight 1 ×1

Length (L)	1.39m
Width (W)	1.04m
Height (H)	0.84m
Weight	3.5t

Rear Counterweight 2 ×1

Length (L)	1.39m
Width (W)	1.04m
Height (H)	0.84m
Weight	3.5t

Transport Dimension

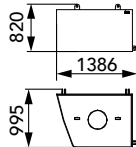

Rear Counterweight 3

×1

Length (L)	1.39m
Width (W)	1.00m
Height (H)	0.82m
Weight	3.5t

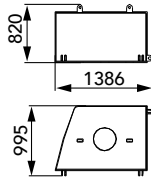

Rear Counterweight 4

×1

Length (L)	1.39m
Width (W)	1.00m
Height (H)	0.82m
Weight	3.5t

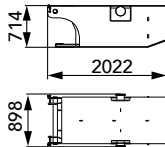

Carbody Counterweight

×2

Length (L)	2.02m
Width (W)	0.90m
Height (H)	0.71m
Weight	3.0t

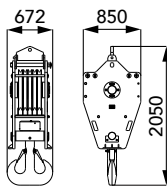

100t Hook

×1

Length (L)	2.05m
Width (W)	0.85m
Height (H)	0.67m
Weight	1.24t

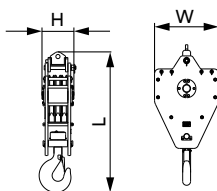

45t Hook (optional)

×1

Length (L)	1.52m
Width (W)	0.69m
Height (H)	0.37m
Weight	0.48t

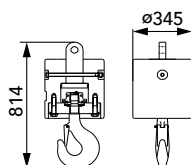

12.5t Hook

×1

Length (L)	0.81m
Width (W)	0.35m
Height (H)	0.35m
Weight	0.3t

Transport Dimension

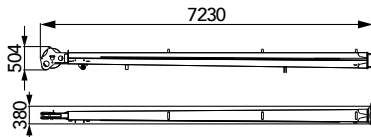

7m Jib (optional)		×1
Length (L)	7.23m	
Width (W)	0.38m	
Height (H)	0.50m	
Weight	1.1t	

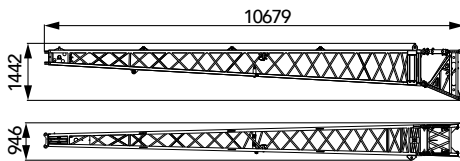

10m Jib (optional)		×1
Length (L)	10.68m	
Width (W)	0.95m	
Height (H)	1.44m	
Weight	0.3t	

Note:

- ① . The component transportation dimensions is schematic diagram, and is not drawn to scale. The marked dimension is design value, excluding the package
- ② . The weight is design value, which may be slightly different because of manufacturing tolerance. Total rear counterweight:32t, total carbody counterweight:6t.
- ③ . After product upgrading of the Company,the outline dimension and weight of the components above may vary,and the new product shall prevail.

Transport Plan

■ Land transport 1:
65.5t basic machine

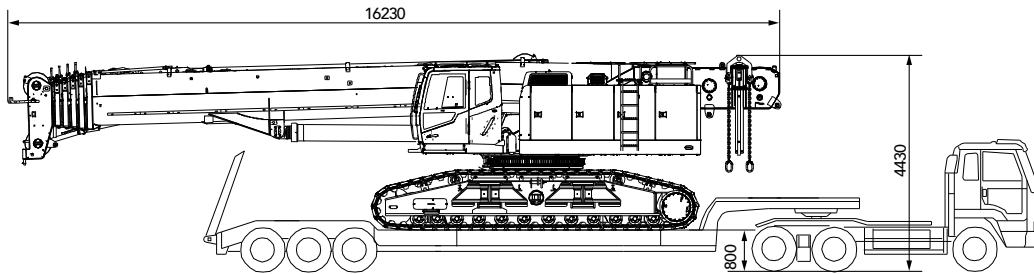

39.5t: Rear counterweight +Carbody Counterweight+hook

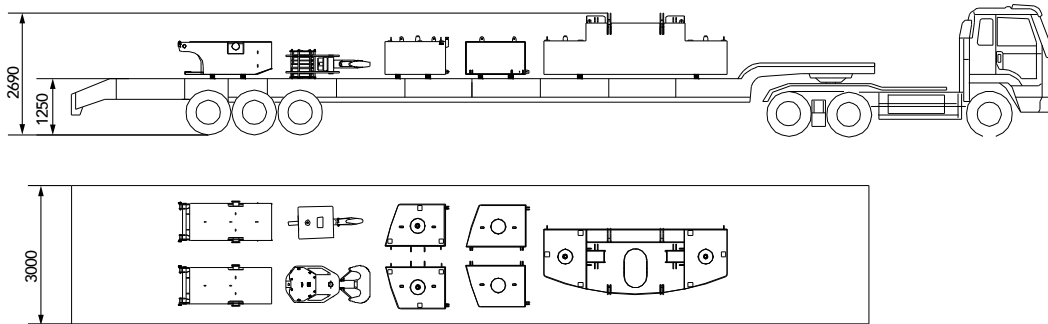

Transport Plan

■ **Land transport 2:**
44.5t basic machine

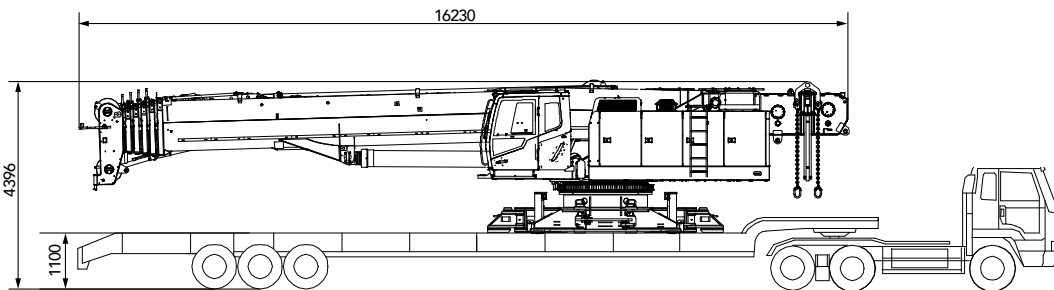

32t: Rear counterweight tray +Rear counterweight 1+Rear counterweight 2+Rear counterweight 3
Rear counterweight tray 4

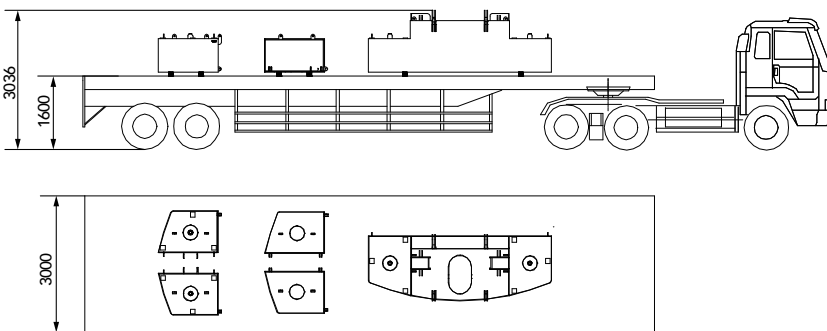

28.5t: Two crawlers+Carbody Counterweight+hook

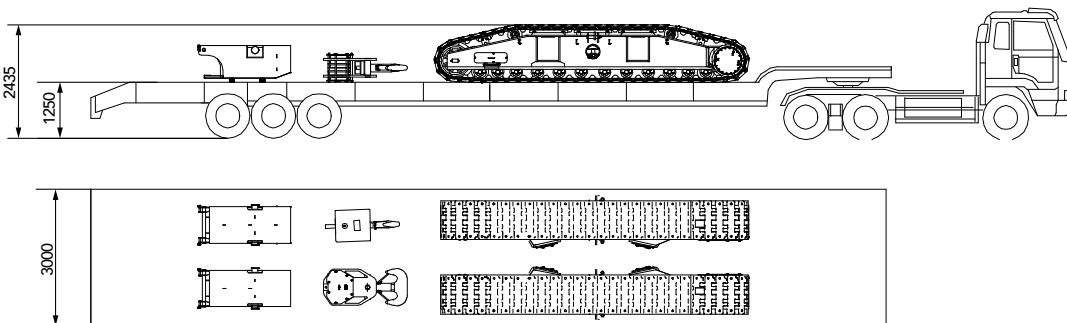



SCC1000TB
TELESCOPIC BOOM CRAWLER CRANE
100 TONS LIFTING CAPACITY

QUALITY CHANGES THE WORLD

Cofigurations

- Page 17 Working range of H
- Page 18 Load Chart of H
- Page 19 Load Chart of FJ

> 16

Working range of H

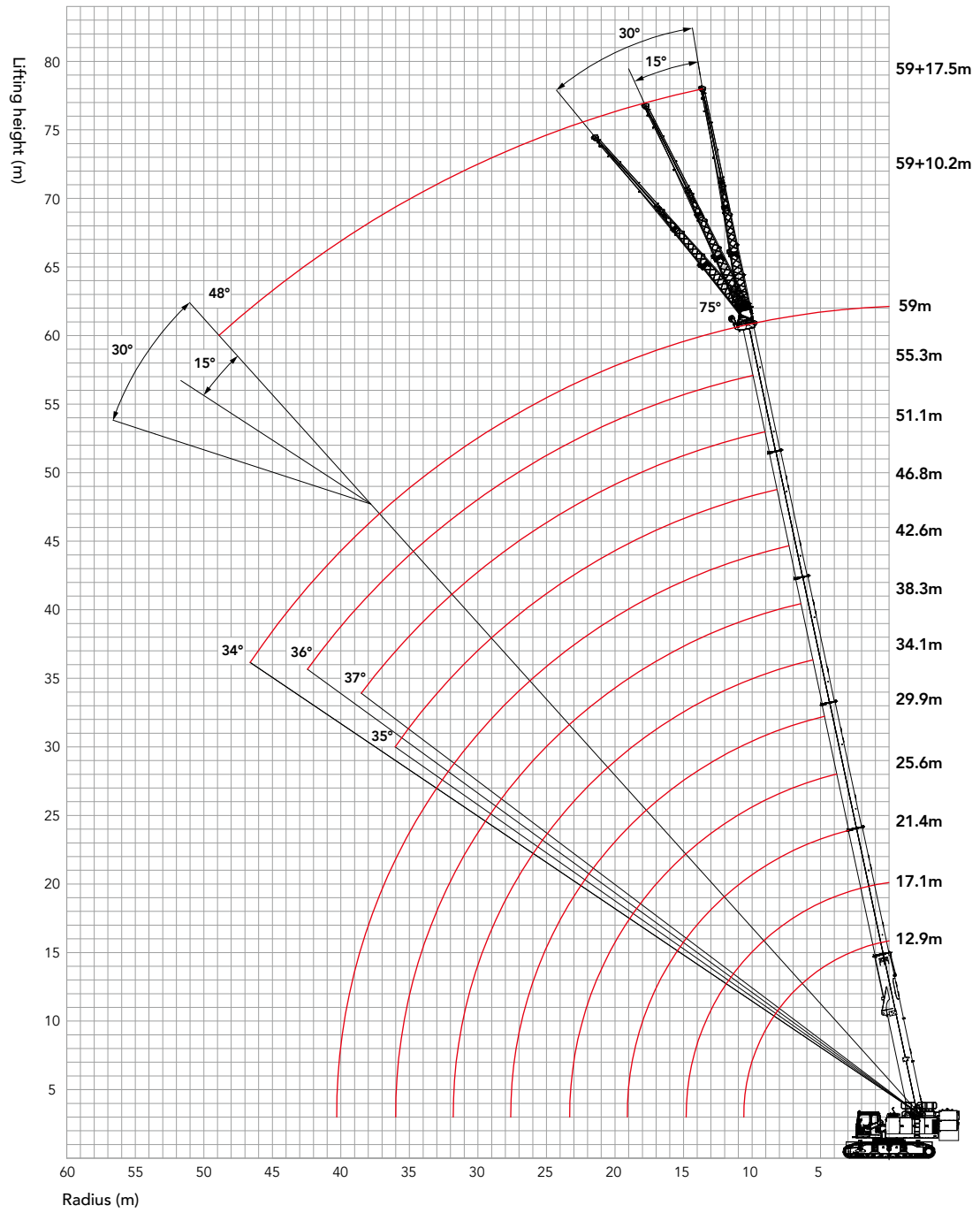

Load Chart of H

Load chart of H													
Rear counterweight 32t, Carbody counterweight:6t, Track gauge:4.4m (gradient:0°)													
Radius (m)	12.9	17.1	21.4	25.6	29.9	34.1	38.3	42.6	46.8	51.1	55.3	59	Radius (m)
3	100	82.5											3
3.5	86	79											3.5
4	82	77	71										4
4.5	78	76	69										4.5
5	73	71	67	66									5
6	63	62	60	56.3									6
7	50.4	50.6	50.4	46.9	45.4								7
8	40.6	40.8	41.4	40	39	38.2							8
9	33.7	33.9	34.4	33.9	34	33.5	29						9
10		28.7	29.3	28.7	29.5	29.7	26.5	25.4					10
12		21.5	22.1	21.6	22.3	23	22.9	21.9	20.6	20.5			12
14			17.3	16.9	17.5	18.2	18.1	17.7	17.7	17.6	16.4	13.5	14
16			14	13.5	14.1	14.8	14.7	14.3	14.5	14.8	14.9	12.5	16
18				11	11.6	12.3	12.2	11.8	12	12.2	12.6	11.5	18
20					9.7	10.3	10.2	9.9	10	10.3	10.6	10.6	20
22					8.1	8.7	8.6	8.3	8.4	8.7	9	9.1	22
24						7.4	7.3	7	7.1	7.4	7.7	7.8	24
26						6.4	6.3	5.9	6.1	6.3	6.7	6.7	26
28								5.4	5	5.2	5.4	5.8	28
30								4.6	4.3	4.4	4.7	5	30
32									3.6	3.7	4	4.3	32
34									3	3.2	3.4	3.7	34
36										2.6	2.9	3.2	36
38										2.2	2.4	2.8	38
40											2	2.4	40
42												2	42
44												1.7	44
46													46
48													48
Min. limit angle	0°	0°	0°	0°	0°	0°	0°	35°	34°	37°	36°	34°	Min. limit angle
II	0	0	46	46	46	46	46	46	46	92	92	100	II
III	0	46	46	46	46	46	46	46	46	92	92	100	III
IV	0	0	0	46	46	46	46	46	92	92	92	100	IV
V	0	0	0	0	46	46	46	92	92	92	92	100	V
VI	0	0	0	0	0	46	92	92	92	46	92	100	VI
Parts of line	11	11	10	9	8	7	6	5	4	3	3	3	Parts of line

Unit: t

Load chart of FJ

Load chart of FJ							
Boom:59m, Carbody counterweight:6t, Rear counterweight 32t, Track gauge:4.4m (gradient:0°)							
Boom angle (°)	Jib:10.2m			Jib:17.5m			Boom angle (°)
	0°	15°	30°	0°	15°	30°	
80	6.8	5.2	4.5	4.0	2.5	1.8	80
78	6.6	5.0	4.5	3.8	2.4	1.7	78
76	6.4	4.8	4.1	3.5	2.3	1.7	76
74	6.2	4.5	3.9	3.2	2.2	1.6	74
72	6.0	4.3	3.8	3.0	2.1	1.6	72
70	5.4	4.2	3.7	2.9	2.0	1.6	70
68	5.2	4.1	3.6	2.8	1.9	1.5	68
66	5.0	3.9	3.5	2.7	1.9	1.5	66
64	4.5	3.7	3.2	2.6	1.9	1.5	64
62	3.8	3.2	2.7	2.5	1.8	1.4	62
60	3.2	2.7	2.3	2.4	1.8	1.4	60
58	2.7	2.3	2.0	2.2	1.8	1.4	58
56	2.3	1.9	1.7	1.9	1.5	1.2	56
54	1.9	1.6	1.4	1.5	1.3	1.0	54
52	1.5	1.3	1.2	1.3	1.0	0.8	52
50	1.2	1.1	1.0	1.0	0.8	0.7	50
48	1.0	0.9	0.8	0.8	0.6	0.5	48
46	0.8	0.7	0.6	0.6			46
44	0.6	0.5					44
42	0.5						42

※ Note-Rate load of crane:

1. The crawler must be extended when lifting.
2. The rated capacity in the load charts are calculated when the crane is parking on firm ground (gradient is within 1°) , and lifting the load slowly and steadily.
3. The rated capacity values in the load charts are obtained when the wind speed is lower than 9.8 m/s under 75% of tipping load.
4. All values in the load charts are valid for 360° slewing.
5. The rated load shall be no more than 10.5t when using upper boom point sheave. If the jib unfolds, the rated lifting capacity of boom is 1.5t less.
6. The rated capacity in the load charts include the weight of lifting hook, therefore, the actual rated capacity is the value after deducting the weight of lifting tools (such as hook, riggings and wire rope), from the rated load in the load charts.
7. The rated values above is just for full-up counterweight and flat ground, See the Operation Manual for the complete load charts .



Zhejiang Sany Equipment Co.,LTD

SANY Crawler Crane Industrial Park, No. 2188 Daishan Road, Wuxing District, Huzhou City, Zhejiang Province, P. R. China Zip 313028

Consulting sanycrane@sanygroup.com (Crane BU) / crd@sany.com.cn (IHQ)

After-sales Service 0086-400 6098 318

Reminder:

Any change in the technical parameters and configuration due to product modification or upgrade may occur without prior notice. The machine in the picture may include additional equipment. This brochure is for reference only, and goods in kind shall prevail. Copyright at SANY. No part of this brochure may be copied or used for any purpose without written approval from SANY.

© Edited in August 2022

