

Metso:Outotec

Nordtrack™ mobile solutions

Contracting  
made more  
productive



TUTT BRYANT





Asphalt recycling



Concrete demolition



Aggregates production

# Dependable solutions for contracting work

The Metso Outotec Nordtrack range of mobile crushing and screening plants makes it easy to get your operations up and running on time and on budget. With standard pre-configured products, and a worldwide sales and support network, Nordtrack is ideal for contractors who need to meet project timelines and capacity quickly.

Nordtrack units are purpose-designed for asphalt recycling, concrete demolition and small scale aggregate production. They are also suitable for screening of coal as well agricultural materials, such as topsoil and wood pellets. They are ideal for short-term contracting jobs or if you are just starting your own operations. Based on field-proven technology to ensure robustness and reliable performance, Nordtrack gives you the availability and productivity that you need.

The delivery time for Nordtrack equipment is just a few weeks on average, and it can be set up and ready to use quickly. In addition, their compact size means that it's easy to transport them between projects, as well. With robust wheels or tracks and remote control, Nordtrack products are also easy to move around the work site, so you can position them exactly where you need them.



Dependability

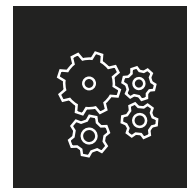

Plug-and-play

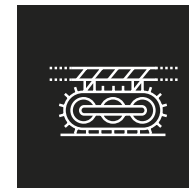

Mobility



Rapid delivery





# Contents

Dependable solutions for contracting work	2
Easy to select and order	4
Worldwide availability and support	4
<b>Impact crushers</b>	
Nordtrack™ I908	6
Nordtrack™ I908S	8
Nordtrack™ I1011	10
<b>Jaw crushers</b>	
Nordtrack™ J90	12
Nordtrack™ J127	14
<b>Safety first</b>	16
<b>Scalping screens</b>	
Nordtrack™ S2.5	18
Nordtrack™ S2.11	20
<b>Product screens</b>	
Nordtrack™ S3.7 & S4.7	22
Nordtrack™ S3.9 & S4.9	24
Nordtrack™ S4.12	26
<b>Stacking conveyors</b>	
Nordtrack™ CT20 & CT24	28
Nordtrack™ CW85 & CW100	30
Nordtrack™ CT85 & CT100	32
Nordtrack™ CT85R & CT100R	34
<b>Ease of operation</b>	
Easy control	37
Remote control crawler track operation	38
Fast service and support	39

# Easy to select and order

You don't have to be a crushing and screening expert to get started with selecting your Nordtrack. The units come in standard configurations for asphalt recycling, separating agricultural materials and aggregate production. The choice of options is limited to features that are necessary for concrete demolition and dust suppression, and which add extra usability — so you only pay for the features that you really need.

The Nordtrack product family includes impact crushers, jaw crushers, screens and conveyors, which offer the right combination of size, productivity and price to match the scale of your operations. Their flexible designs also mean that they can handle different needs, including a variety of feed materials and end-product requirements.



Crushers



Screens



Conveyors

## The Nordtrack range:

- Impact crushers
- Jaw crushers
- Scalping screens
- Product screens
- Stacking conveyors

## Worldwide availability and support

Nordtracks are available from Metso Outotec and distributor sales worldwide. We also supply all the parts, service and technical support you need, to ensure your business keeps running smoothly.

Nordtrack mobile solutions are engineered to the highest HSE standards for safe operation, with CE certification. Safety features include remote controllers, safety buttons, easy to access maintenance points, safety guards and hand rails.



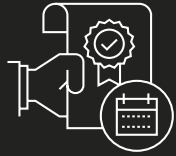

Every Nordtrack product is backed up by Metso Outotec's standard warranty





# Nordtrack™ I908 mobile impact crusher

## The small and agile powerhouse

For the smaller jobsites where quick performance is valued

Controlled from the user-friendly automation panel this compact unit provides extremely efficient throughput. The Nordtrack™ I908 is offered with wide variety of different impact hammers for many applications from martensitic hammers recommended for concrete crushing to chromium iron hammers for reclaimed asphalt crushing. Clutch-driven direct drive system provides highly efficient fuel consumption to crushing ratio and compact design saves on transportation costs.

**Areas of application:**

-  ●●●● Asphalt recycling
-  ●●● Construction waste crushing
-  ●●●●● Bricks & tiles
-  ●●● Soft rock
-  ●●●● Coal



\* Optional, not included in standard delivery



High performance crushing in a compact size



Easy to use and easy to service



Easy to transport and move on-site



Fuel-efficient direct drive system



# Technical details Nordtrack™ I908

## Crusher



**Feed opening**  
860 x 650 mm  
(34 x 25.6")

## Feeder



**Hopper capacity**  
2.8 m<sup>3</sup> (3.6 yd<sup>3</sup>)

**Options**  
Multiple grizzly bar and punch plate aperture options with easily changeable cassette

## Conveyors



**Product conveyor**  
900 mm (36") wide

**Side conveyor (optional)**  
Belt width 500 mm (20")

## Engine power options



**Tier 3 (Stage III A):**  
Volvo D8 188 kW (252 hp)

**Tier 4F:**  
Volvo D8 188 kW (252 hp)

**Stage V:**  
Volvo D8 188 kW (252 hp)

## Transport dimensions

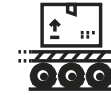

**Weight**  
23.6 t (52,000 lb)

**Width**  
2.5 m (8' 2")

**Height**  
3.0 m (10')

**Length**  
9.3 m (30' 7")



# Nordtrack™ I908S mobile impact crusher

## A highly competitive recycling crusher

Designed to get crushing operations up and running quickly

The Nordtrack™ I908S mobile impact crusher provides high performance crushing in a very compact size. The hanging screen module with easy to use attachment system and the 180 degree radial conveyor makes this unit flexible enough for various types of jobs.

**Areas of application:**

-  Asphalt recycling
-  Construction waste crushing
-  Bricks & tiles
-  Soft rock
-  Coal

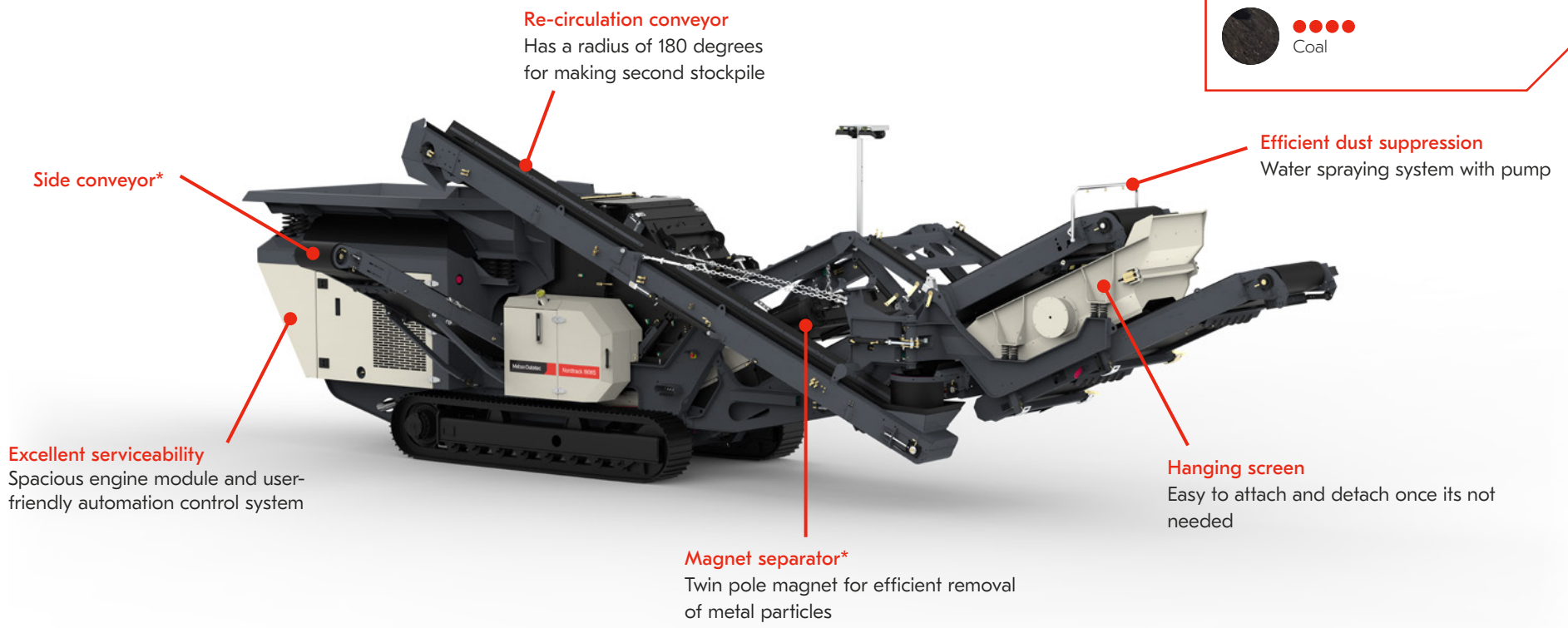

\* Optional, not included in standard delivery



High performance crushing in a compact size



Calibrated and accurate end product



Easy to transport and move on-site



Fuel-efficient direct drive system



# Technical details Nordtrack™ I908S

## Crusher



**Feed opening**  
860 x 650 mm  
(34 x 25.6")

## Screen



**Hanging screen**  
2,000 x 1,100 mm  
(6'7" x 3'7")

**Screen angle**  
25 degrees

**Stroke**  
8 mm

## Feeder



**Hopper capacity**  
2.8 m<sup>3</sup> (3.6 yd<sup>3</sup>)

**Options**  
Multiple grizzly bar and punch plate aperture options with easily changeable cassette

## Conveyors



**Main conveyor**  
900 mm (36") wide

**Product conveyor**  
900 mm (36") wide

**Radial re-circulation conveyor**  
400 mm (16") wide

**Side conveyor (optional)**  
Belt width 500 mm (20")

## Engine power options



**Tier 3 (Stage III A):**  
Volvo D8 188 kW (252 hp)

**Tier 4F:**  
Volvo D8 188 kW (252 hp)

**Stage V:**  
Volvo D8 188 kW (252 hp)

## Transport dimensions

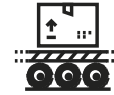

**Weight**  
27.5 t (60,700 lb)

**Width**  
2.7 m (8' 10")

**Height**  
3.0 m (10')

**Length**  
12.8 m (42')



# Nordtrack™ I1011 mobile impact crusher

## High performance with small footprint

### Compact and powerful impactor for contractors and as a rental

The Nordtrack™ I1011 mobile impact crusher combines high crushing capacity and end product accuracy with the large hanging screen (optional). This versatile crusher is suitable to work in different jobsites from rock crushing to construction and demolition waste recycling. The small footprint makes it easy to use in tight places and quick to transport with standard trailer between jobsites. Different blowbar options and crusher settings makes any job available with this machine.

**Areas of application:**

-  Asphalt recycling
-  Construction waste crushing
-  Bricks & tiles
-  Soft rock
-  Coal

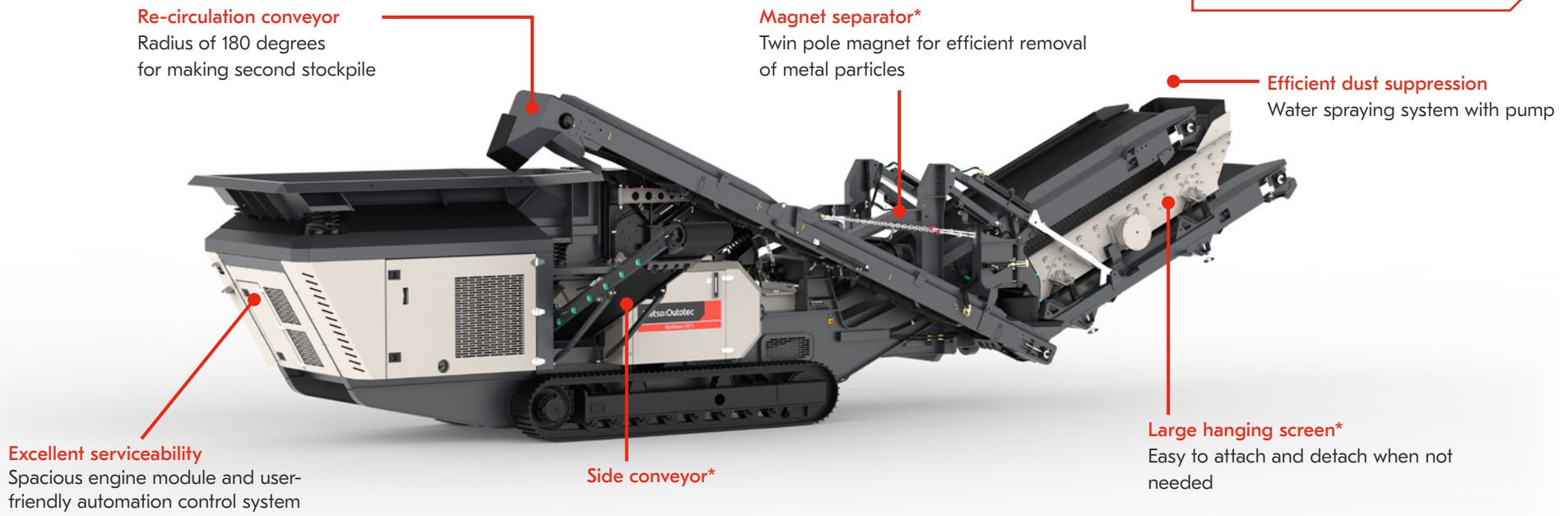

**Re-circulation conveyor**  
Radius of 180 degrees for making second stockpile

**Magnet separator\***  
Twin pole magnet for efficient removal of metal particles

**Efficient dust suppression**  
Water spraying system with pump

**Large hanging screen\***  
Easy to attach and detach when not needed

**Excellent serviceability**  
Spacious engine module and user-friendly automation control system

**Side conveyor\***

\* Optional, not included in standard delivery



Versatile solution for rental and plant hires



Calibrated and accurate end product



Easy to transport and move on-site



Fuel-efficient direct drive system



# Technical details Nordtrack™ I1011

## Crusher



**Feed opening**  
1150 x 800 mm  
(45 x 32")

## Screen\*



**Hanging screen**  
3,660 x 1,530 mm  
(12' x 5')

**Screen angle**  
25 degrees

**Stroke**  
9 mm

## Feeder



**Hopper capacity**  
3.8 m<sup>3</sup> (5 yd<sup>3</sup>)

**Options**  
Multiple grizzly bar and  
punch plate aperture  
options

## Conveyors



**Main conveyor**  
1,200 mm (48") wide

**Product conveyor\***  
1,200 mm (48") wide

**Re-circulation conveyor\***  
500 mm (20") wide

**Side conveyor\***  
600 mm (24") wide

## Engine power options



**Tier 3 (Stage III A):**  
CAT C9.3B 280 kW  
(375 hp)

**Tier 4F:**  
CAT C9.3B 280 kW  
(375 hp)

**Stage V:**  
CAT C9.3B 280 kW  
(375 hp)

## Transport dimensions\*\*



**Weight**  
41.5 t (91,600 lb)

**Width**  
3 m (9' 11")

**Height**  
3.3 m (10' 11")

**Length**  
15.8 m (51' 10")

\* Optional \*\* with screen module



# Nordtrack™ J90 mobile jaw crusher

## Powerful crushing in a compact size

Made to be mobile for efficient crushing where you need it

The Nordtrack™ J90 mobile jaw crusher gives you excellent crushing performance in a compact and mobile package. With a durable and heavy-duty design, it gives you the reliability you need for your crushing operations in an easily transported form.

**Areas of application:**

-  ●●● Hard rock
-  ●●●●● Concrete demolition
-  ●●●●● Construction waste crushing
-  ●●●●● Sand and gravel

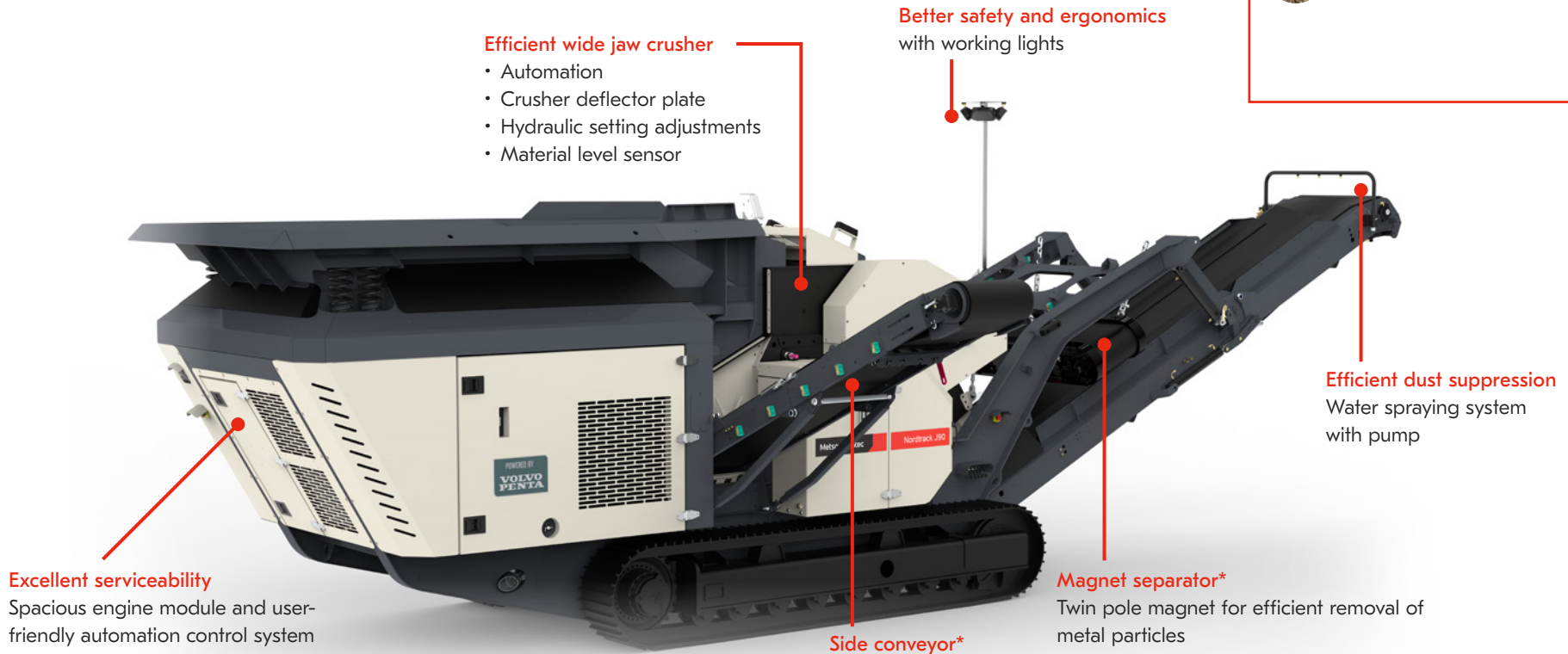

\* Optional, not included in standard delivery



High performance crushing  
in a compact size



Easy to use and  
easy to service



Easy to transport  
and move on-site



Versatile solution for  
rental and plant hires



# Technical details Nordtrack™ J90

## Crusher



**Feed opening**  
890 x 500 mm (35 x 20")

## Feeder



**Hopper capacity**  
2.8 m<sup>3</sup> (3.6 yd<sup>3</sup>)

### Options

Multiple grizzly bar and punch plate aperture options with easily changeable cassette

## Conveyors



**Main conveyor**  
900 mm (36")

**Side conveyor (optional)**  
Belt width: 500 mm (20")

## Engine options



**Tier 3 (Stage III A):**  
Volvo D5 162 kW (218 hp)

**Tier 4F:**  
Volvo D5 162 kW (218 hp)

**Stage V:**  
Volvo D5 162 kW (218 hp)

## Transport dimensions

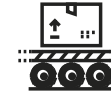

**Weight**  
23.9 t (52,600 lbs)

**Width**  
2.5 m (8' 2")

**Height**  
3.0 m (10')

**Length**  
9.3 m (30' 7")



# Nordtrack™ J127 mobile jaw crusher

## Extreme throughput capacity

### Ready for high productivity crushing

The Nordtrack™ J127 mobile jaw crusher is made to deliver high productivity quickly. The wide jaw crusher and the two-stage feeder enable high throughput in both quarry and recycling operations.

#### High capacity feeder with durable structure

- Highly resistant wear plates
- Two-stage pan feeder and scalper grizzly

#### Simple and fast to open and to fold the feeder with:

- Hydraulic cylinders
- Hydraulic wedging system

#### Hydraulically operated telescope side conveyor

- Reduces material moves due to higher piling
- Can be installed on either side
- Simple to fold for transportation

#### Efficient dust suppression

- Water spraying system with pump
- Aluminum covers

#### High throughput crushing

- In-house designed wide jaw crusher with material level sensor
- Crusher deflector plate
- Hydraulic setting adjustments

#### Areas of application:

-  Construction waste crushing
-  Concrete demolition
-  Hard rock
-  Sand and gravel

#### Magnet separator\*

Twin pole magnet for efficient removal of metal particles

\* Optional, not included in standard delivery



High performance crushing



Robust two-stage feeder for high tonnages



Durable and reliable design



Versatile solution for rental and plant hires



# Technical details Nordtrack™ J127

## Crusher



**Feed opening**  
1,270 x 735 mm  
(50" x 29")

## Panfeeder and scalper



**Hopper capacity**  
6.8 m<sup>3</sup> (8.9 yd<sup>3</sup>)

**Scalper**  
Total area  
2,120 x 1,204 mm  
(83.5" x 47.4")

**Bottom deck mesh**  
1,200 x 1,220 mm  
(47.2" x 48")

Ultrasonic material level sensor to prevent overload of the crusher rock box

## Conveyors



**Main conveyor**  
1,200 mm (48") wide

**Side conveyor**  
Hydraulically folding  
fines conveyor:  
length 2.6 m (8' 6"),  
width 650 mm (26")

## Engine options



**Tier 3 (Stage III A):**  
CAT C9.3B 280 kW  
(375 hp)

**Tier 4F:**  
CAT C9.3B 280 kW  
(375 hp)

**Stage V:**  
CAT C9.3B 280 kW  
(375 hp)

## Transport dimensions

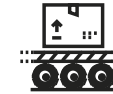

**Weight**  
56.5 t (124,600 lbs)

**Width**  
3.0 m (9' 10")

**Height**  
3.6 m (11' 8.8")

**Length**  
15.5 m (50' 8")



# Safety First





Working lights as standard for better work ergonomics and safety.



Water spraying system for efficient dust suppression, pump included.



Remote controller for crawler tracks as standard.



Crusher automation always as standard for ease of use.

# Nordtrack™ S2.5 mobile scalping screen

## Small and agile two deck scalper

### Versatility and cost-effective productivity in one package

The Nordtrack™ S2.5 mobile scalping screen is designed for small jobsites and for various different applications. It comes with a variety of different screening media for the highly effective 2-deck screen. It can be used as a pre-scalper or a tertiary screener for up to 450 tph capacity process. The compact design and robust chassis makes it cost-effective for contracting jobs where site locations change frequently.

**Areas of application:**

-  Sand and gravel
-  Agricultural materials screening
-  Aggregate screening
-  Coal

#### Compact transport dimensions for contracting jobs

- Extensive screening media choice for various applications
- Easy maintenance with good accessibility

#### High capacity feeder with durable structure

- Belt feeder
- Apron feeder\*
- Highly resistant wear plates
- Remote controller for feeder speed and on/off

#### Efficient dust suppression

Water spraying system with pump\*

#### Fuel efficient drive system

Dual Power upgrade kit to drive the hydraulics with external electric power\*

Possibility for two-way split\*

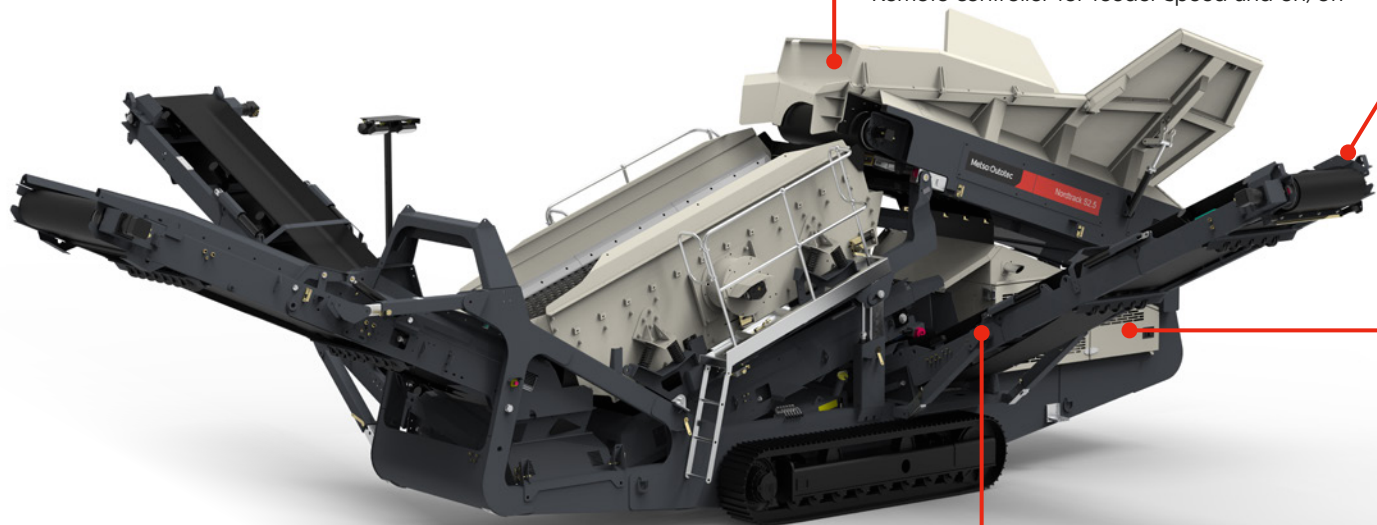

\* Optional, not included in standard delivery



High capacity in a compact size



Mobile and easy to move on-site



Wide range of media options for different applications



Easy to use and maintain



# Technical details Nordtrack™ S2.5

## Screen



**Top deck**  
3,660 x 1,370 mm  
(12' x 4' 6")

**Bottom deck**  
3,460 x 1,370 mm  
(11' 4" x 4' 6")

### Options for screening media

- Punch plate
- Plate grizzly / bofor bar
- Heavy duty fingers
- Woven screen mesh

**Stroke**  
10 mm

## Feeder



**Belt feeder as standard, apron feeder as option**

**Hopper capacity**  
6.0 m<sup>3</sup> (7.8 yd<sup>3</sup>)

## Conveyors



**Fines conveyor**  
800 mm (32")

**Mid-fraction conveyor**  
800 mm (32")

**Oversize conveyor**  
1,200 mm (48")

## Engine options



**Tier 3 (Stage III A):**  
CAT C4.4 98 kW (131 hp)

**Tier 4F:**  
CAT C3.6 100 kW (134 hp)

**Stage V:**  
Deutz TCD 3.6 100 kW  
(134 hp)

## Transport dimensions



**Weight**  
23.0 t (50,700 lbs)

**Width**  
2.5 m (8' 2")

**Height**  
3.2m (10' 6")

**Length**  
13.0 m (42' 10")



# Nordtrack™ S2.11 mobile scalping screen

## Heavy duty high capacity screening

Made to deliver versatile, all around screening

The Nordtrack™ S2.11 mobile scalping screen handles massive volumes of feed material with precision. It gives you the flexibility to screen a wide variety of feed materials in different recycling, demolition and aggregate applications, and is able to reach over 800 tph screening potential depending on application.

**Areas of application:**

-  ●●● Concrete waste screening
-  ●●●●● Sand and gravel
-  ●●● Agricultural materials screening
-  ●●●●● Aggregate screening

**High capacity feeder with durable structure**

- Belt feeder
- Apron feeder\*
- Highly resistant wear plates
- Remote controller for feeder speed and on/off

**High volumes and precision**

Wide fines conveyor

**High capacity versatile screening**

- Massive screenbox
- Extensive screening media choice

**Efficient dust suppression**

Water spraying system with pump\*

**Fuel efficient drive system**

Dual Power upgrade kit to drive the hydraulics with external electric power\*

Possibility for two-way split\*

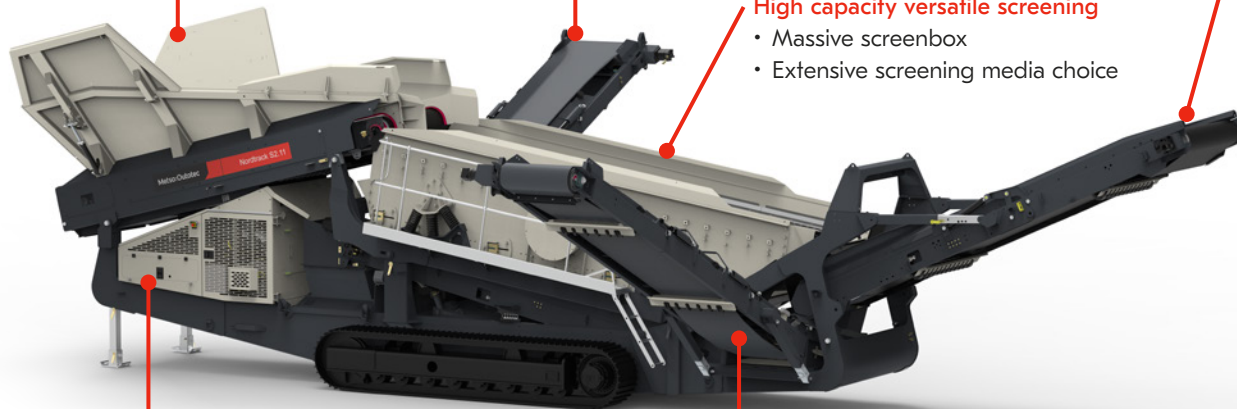

\* Optional, not included in standard delivery



High capacity screening



Wide range of media options for different applications



Easy to control and move on-site



Durable and reliable design



# Technical details Nordtrack™ S2.11

## Screen



### Top deck

6,100 x 1,800 m (20' x 6')

### Bottom deck

5,500 x 1,800 m (18' x 6')

### Options for screening media

- Punch plate
- Plate grizzly / bofor bar
- Heavy duty fingers
- Woven screen mesh

### Stroke

10 mm

## Feeder



Belt feeder as standard, apron feeder as option

### Hopper capacity

11.5 m<sup>3</sup> (15.0 yd<sup>3</sup>)

## Conveyors



Fines conveyor  
1,050 mm (42")

Mid-fraction conveyor  
900 mm (36")

Oversize conveyor  
1,600 mm (64")

## Engine options



Tier 3 (Stage III A):  
CAT C7.1 209 kW (281 hp)

Tier 4F:  
CAT C7.1 168 kW 225 (hp)

Stage V:  
CAT C7.1 168 kW (225 hp)

## Transport dimensions



Weight  
37.2 t (82,000 lbs)

Width  
3.0 m (9' 10")

Height  
3.5 m (11' 6")

Length  
17.0 m (55' 8")



# Nordtrack™ S3.7 & S4.7 mobile screens

## Compact screening with two or three decks

### Designed to let you start screening operations fast

The Nordtrack™ S3.7 and S4.7 are compact and efficient mobile screens that are simple to set up and operate. Their compact folding design makes them convenient to transport, and due to their large screenbox, they have high productivity as well with potential up to 450 tph (depending on application).

### Efficient dust suppression

Water spraying system with pump\*

**Areas of application:**

-  ●●●● Sand and gravel
-  ●●●● Agricultural materials screening
-  ●●●●● Aggregate screening
-  ●●●● Coal

### Better safety and ergonomics

Remote controller for feeder functionalities (e.g. speed, start/stop, grid tilting)



### Excellent serviceability

- Three-way platform
- Working lights
- Lifting cylinders on conveyors to make more maintenance space for mesh change

### Fuel efficient drive system

- Dual Power upgrade kit to drive the hydraulics with external electric power\*
- Possibility to plug-in accessories (hydraulic PTO)\*

Nordtrack™ S3.7 pictured

\* Optional, not included in standard delivery



High capacity in a compact size



Mobile and easy to move on-site



Possible to pair to closed circuit with Metso Lokotrack mobile crusher



Easy to use and maintain



# Technical details Nordtrack™ S3.7 & S4.7

## Screen



### Nordtrack™ S3.7 mobile screening unit

**Top deck**  
4,270 x 1,524 mm (14' x 5')

**Bottom deck**  
3,660 x 1,524 mm (12' x 5')

**Stroke**  
8 mm

## Feeder



**Hopper capacity**  
10.0 m<sup>3</sup> (13.1 yd<sup>3</sup>)

**Static grizzly**  
100 mm (4") spacing

**Options**  
Vibrating two-deck grid  
(on request)

## Conveyors



**Lifting conveyor**  
1,050 mm (42")

**Fines conveyor**  
1,200 mm (48")

**Mid-fraction conveyor**  
650 mm (26")

**Oversize conveyor**  
650 mm (26")

## Engine options



**Tier 3 (Stage III A):**  
CAT C4.4 98 kW (131 hp)

**Tier 4F:**  
CAT C4.4 102 kW (137 hp)

**Stage V:**  
Deutz TCD 3.6 100 kW (134 hp)

## Transport dimensions



**Weight**  
28.0 t (61,750 lbs)

**Width**  
3.0 m (9' 10")

**Height**  
3.5 m (11' 6")

**Length**  
16.4 m (53' 9")

### Nordtrack™ S4.7 mobile screening unit

**Top deck**  
4,270 x 1,524 mm (14' x 5')

**Middle deck**  
4,270 x 1,524 mm (14' x 5')

**Bottom deck**  
3,660 x 1,524 mm (12' x 5')

**Stroke**  
8 mm

**Hopper capacity**  
10.0 m<sup>3</sup> (13.1 yd<sup>3</sup>)

**Static grizzly**  
100 mm (4") spacing

**Options**  
Vibrating two-deck grid  
(on request)

**Lifting conveyor**  
1,050 mm (42")

**Fines conveyor**  
1,200 mm (48")

**Mid-fraction conveyors**  
650 mm (26")

**Oversize conveyor**  
650 mm (26")

**Tier 3 (Stage III A):**  
CAT C4.4 98 kW (131 hp)

**Tier 4F:**  
CAT C4.4 102 kW (137 hp)

**Stage V:**  
Deutz TCD 3.6 100 kW (134 hp)

**Weight**  
32.0 t (70,600 lbs)

**Width**  
3.3 m (10' 8")

**Height**  
3.5 m (11' 6")

**Length**  
16.6 m (54' 4")



Robust tipping grid with remote controllable tilting. Possibility to offer also vibrating grid



Six emergency stops, start siren, engine shutdown system and nip point guards for safety



# Nordtrack™ S3.9 & S4.9 mobile screens

## High volume screening with two or three decks

### Made to boost your screening capacity quickly

The Nordtrack™ S3.9 and S4.9 are high capacity mobile screens that are easy to transport and move between work sites. They're designed to let you increase your screening capacity quickly, wherever it's needed. The powerful lifting conveyor makes sure the screenbox is utilized to maximum capacity and can reach up to 600 tph potential (depending on application).

#### Areas of application:

-  ●●●●● Sand and gravel
-  ●●●●● Agricultural materials screening
-  ●●●●● Aggregate screening
-  ●●●●● Coal

#### Better safety and ergonomics

Remote controller for feeder functionalities (e.g. speed, start/stop, grid tilting)

#### Efficient dust suppression

Water spraying system with pump\*

#### Excellent serviceability

- Three-way platform
- Working lights
- Lifting cylinders on conveyors to make more maintenance space for mesh change

#### Fuel efficient drive system

- Dual Power upgrade kit to drive the hydraulics with external electric power\*
- Possibility to plug in accessories (hydraulic PTO)

Nordtrack™ S3.9 pictured

\* Optional, not included in standard delivery



Versatile solution for rental and plant hires



Mobile and easy to move on-site



Possible to pair to closed circuit with Metso Lokotrack mobile crusher



Robust and reliable design



# Technical details Nordtrack™ S3.9 & S4.9

## Screen



### Nordtrack™ S3.9 mobile screening unit

**Top deck**  
6,100 x 1,524 mm (20' x 5')

**Bottom deck**  
5,490 x 1,524 mm (18' x 5')

**Stroke**  
8 mm

## Feeder



**Hopper capacity**  
10.0 m<sup>3</sup> (13.1 yd<sup>3</sup>)

**Static grizzly**  
100 mm (4") spacing

**Options**  
Vibrating two-deck grid  
(on request)

## Conveyors



**Lifting conveyor**  
1,050 mm (42")

**Fines conveyor**  
1,200 mm (48")

**Mid-fraction conveyor**  
800 mm (32")

**Oversize conveyor**  
800 mm (32")

## Engine options



**Tier 3 (Stage III A):**  
CAT C4.4 98 kW (131 hp)

**Tier 4F:**  
CAT C4.4 102 kW (137 hp)

**Stage V:**  
Deutz TCD 3.6 100 kW (134 hp)

## Transport dimensions



**Weight**  
36.4 t (80,300 lbs)

**Width**  
3.0 m (9' 10")

**Height**  
3.5 m (11' 6")

**Length**  
18.5 m (60' 6")

### Nordtrack™ S4.9 mobile screening unit

**Top deck**  
6,100 x 1,524 mm (20' x 5')

**Middle deck**  
6,100 x 1,524 mm (20' x 5')

**Bottom deck**  
5,490 x 1,524 mm (18' x 5')

**Stroke**  
8 mm

**Hopper capacity**  
10.0 m<sup>3</sup> (13.1 yd<sup>3</sup>)

**Static grizzly**  
100 mm (4") spacing

**Options**  
Vibrating two-deck grid  
(on request)

**Lifting conveyor**  
1,050 mm (42")

**Fines conveyor**  
1,200 mm (48")

**Mid-fraction conveyors**  
800 mm (32")

**Oversize conveyor**  
650 mm (26")

**Tier 3 (Stage III A):**  
CAT C4.4 98 kW (131 hp)

**Tier 4F:**  
CAT C4.4 102 kW (137 hp)

**Stage V:**  
Deutz TCD 3.6 100 kW (134 hp)

**Weight**  
38.8 t (85,500 lbs)

**Width**  
3.3 m (10' 8")

**Height**  
3.5 m (11' 4")

**Length**  
18.5 m (60' 6")



# Nordtrack™ S4.12 mobile screen

## Heavy duty screening with three decks

### Tough and powerful for dependable screening performance

The Nordtrack™ S4.12 mobile screening unit is a big, heavy-duty three-deck screener for high volume screening able to reach over 800tph total screening potential (depending on application). The big hopper accepts also wheel loader feed but is also the perfect match for Metso Lokotrack mobile crusher for a closed circuit feed.

**Areas of application:**

-  Sand and gravel
-  Agricultural materials screening
-  Aggregate screening
-  Coal

**Better safety and ergonomics**

Remote controller for feeder functionalities (e.g. speed, start/stop, grid tilting)

**Efficient dust suppression**

Water spraying system with pump\*



**Excellent serviceability**

- three-way platform
- working lights
- lifting cylinders on conveyors to make more maintenance space for mesh change

**Powerful drive system**

Possibility to plug in accessories (hydraulic PTO)

\* Optional, not included in standard delivery



Dependable, heavy duty design



High volume screening



Possible to pair to closed circuit with Metso Lokotrack mobile crusher



Easy to use and maintain



# Technical details Nordtrack™ S4.12

## Screen



### Top deck

6,710 x 1,830 mm (22' x 6')

### Middle deck

6,710 x 1,830 mm (22' x 6')

### Bottom deck

6,100 x 1,830 mm (20' x 6')

### Stroke

10 mm

## Feeder



### Hopper capacity

10.0 m<sup>3</sup> (13.1 yd<sup>3</sup>)

### Static grizzly

100 mm (4") spacing

### Options

Vibrating two-deck grid  
(on request)

## Conveyors



### Lifting conveyor

1,200 mm (48")

### Fines conveyor

1,400 mm (55")

### Mid-fraction conveyors

900 mm (36")

### Oversize conveyor

800 mm (32")

## Engine options



### Tier 3 (Stage III A):

CAT C7.1 209 kW (281 hp)

### Tier 4F:

CAT C7.1 168 kW (225 hp)

### Stage V:

CAT C7.1 168 kW (225 hp)

## Transport dimensions



### Weight

42.4 t (93,600 lbs)

### Width

3.7 m (12' 2")

### Height

3.6 m (11' 10")

### Length

19.6 m (64' 2")



# Nordtrack™ CT20 & CT24

## Compact tracked stacking conveyors

### Tracked conveyors that deliver efficiency and cost savings

Nordtrack™ CT20 and CT24 mobile stacking conveyors are a cost-effective alternative to wheel loaders. By eliminating the need for extra handling with wheel loaders, these conveyors reduce your running costs and improve your end product quality.



**Different options for the belt conveyor:**

- Chevron belt
- Full skirting
- Anti-rollback rubber mats

**Easy transport and set-up**

- Allows for quick start-up of operations
- Fits in a container for transport

**Easy to move on-site**

Wired remote controller for hydraulically driven crawler tracks

Nordtrack™ CT20 pictured  
Not available in North America



More cost-effective than wheel loaders



Mobile and easy to move on-site



Reduces traffic on-site for improved health and safety



Made for convenient transport



# Technical details Nordtrack™ CT20 & CT24

## Conveyor



### Nordtrack™ CT20 mobile stacking conveyor

**Belt length**  
19.4 m (63' 5")

**Belt width**  
1,000 mm (40")

### Nordtrack™ CT24 mobile stacking conveyor

**Belt length**  
23.5 m (77' 3")

**Belt width**  
1,000 mm (40")

## Capacity



**Hopper capacity**  
3.0 m<sup>3</sup> (3.9 yd<sup>3</sup>)

**Stockpile height**  
8.4 m (27' 8")

**Stockpile capacity**  
991 m<sup>3</sup> (1296 yd<sup>3</sup>)

**Hopper capacity**  
3.0 m<sup>3</sup> (3.9 yd<sup>3</sup>)

**Stockpile height**  
9.7 m (31' 10")

**Stockpile capacity**  
1,685 m<sup>3</sup> (2200 yd<sup>3</sup>)

## Drive options



### Diesel engine

**Tier 3 (Stage III A):**  
Isuzu 4LE1 37 kW (49 hp)

**Stage V:**  
Deutz TCD 2.2 50 kW (67 hp)

### Diesel engine

**Tier 3 (Stage III A):**  
Isuzu 4LE1 37 kW (49 hp)

**Stage V**  
Deutz TCD 2.2 50 kW (67 hp)

## Transport dimensions

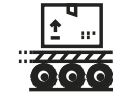

### Weight

10.5 t (23,150 lbs)

### Width

2.3 m (7' 6")

### Height

2.5 m (8' 3")

### Length

12.1 m (39' 9")

### Weight

12.9 t (28,420 lbs)

### Width

2.3 m (7' 6")

### Height

2.7 m (8' 9")

### Length

12.2 m (39' 11")



## Nordtrack™ CW85 & CW100

# Heavy-duty wheeled mobile stacking conveyors

### Tough conveyors that give you long-lasting performance

Nordtrack™ CW85 and CW100 wheeled stacking conveyors provide heavy-duty dependability in a mobile package. By replacing wheel loaders and eliminating double-handling of materials, they can reduce your material cost per ton.



Nordtrack™ CW85 pictured  
Available only in North America



More cost-effective than  
wheel loaders



Mobile and easy to  
move on-site



Reduces traffic on-site for  
improved health and safety



Durable and reliable



# Technical details Nordtrack™ CW85 & CW100

## Conveyor



### Nordtrack™ CW85 mobile stacking conveyor

**Belt length**  
24.4 m (80')

**Belt width**  
900 mm (36")

### Nordtrack™ CW100 mobile stacking conveyor

**Belt length**  
30.5 m (100')

**Belt width**  
900 mm (36")

## Capacity



**Hopper capacity**  
1.5 m<sup>3</sup> (2.0 yd<sup>3</sup>)

**Stockpile height**  
9.3 m (30' 6")

**Stockpile capacity**  
1,482 m<sup>3</sup> (1938 yd<sup>3</sup>)

**Hopper capacity**  
1.5 m<sup>3</sup> (2.0 yd<sup>3</sup>)

**Stockpile height**  
12.2 m (40' 0")

**Stockpile capacity**  
3,342 m<sup>3</sup> (4371 yd<sup>3</sup>)

## Drive options



### No engine

External hydraulic power source or  
External electric power supply (electric  
conveyor drive motor)

### Diesel engine

**Tier 4F:**  
CAT C2.2 37 kW (49 hp)

**Tier 4F - power upgrade:**  
CAT C2.8 55 kW (74 hp)

### No engine

External hydraulic power source or  
External electric power supply (electric  
conveyor drive motor)

### Diesel engine

**Tier 4F:**  
CAT C2.8 55 kW (74 hp)

**Tier 4F - power upgrade:**  
CAT C3.4 75 kW (100 hp)

## Transport & dimensions



### Weight

9.0 t (20,000 lbs)

### Width

3.2 m (10' 3" )

### Height

4.2 m (13' 9")

### Length

18.7 m (61' 5")

### Weight

11.3 t (25,000 lbs)

### Width

3.3 m (10' 11")

### Height

4.4 m (14' 5")

### Length

22.5 m (73' 6")



## Nordtrack™ CT85 & CT100

# Heavy-duty tracked mobile stacking conveyors

Made to give you dependable, heavy-duty performance

Nordtrack™ CT85 and CT100 tracked stacking conveyors deliver heavy-duty reliability combined with convenient mobility. They include remote controlled crawler tracks as standard for easy on-site positioning. They also give you the capacity you need to replace wheel loaders.

Heavy-duty construction and easy servicing for continuous performance

Different hopper options for higher volumes

Agile and easy to move on-site  
Remote controlled hydraulically driven crawler tracks 🎮

Nordtrack™ CT100 pictured  
Available only in North America



More cost-effective than wheel loaders



Mobile and easy to move on-site



Reduces traffic on-site for improved health and safety



Reliable, heavy-duty performance



# Technical details Nordtrack™ CT85 & CT100

## Conveyor



### Nordtrack™ CT85 mobile stacking conveyor

**Belt length**  
24.4 m (80')

**Belt width**  
900 mm (36")

### Nordtrack™ CT100 mobile stacking conveyor

**Belt length**  
30.5 m (100')

**Belt width**  
900 mm (36")

## Capacity



**Hopper capacity**  
1.5 m<sup>3</sup> (2.0 yd<sup>3</sup>)

**Stockpile height**  
10.0 m (32' 10")

**Stockpile capacity**  
1,848 m<sup>3</sup> (2418 yd<sup>3</sup>)

**Hopper capacity**  
1.5 m<sup>3</sup> (2.0 yd<sup>3</sup>)

**Stockpile height**  
12.4 m (40' 7")

**Stockpile capacity**  
3,490 m<sup>3</sup> (4565 yd<sup>3</sup>)

## Drive options



**Diesel engine**  
**Tier 4F:**  
CAT C2.2 37 kW (49 hp)  
**Tier 4F - power upgrade:**  
CAT C2.8 55 kW (74 hp)

**Diesel engine**  
**Tier 4F:**  
CAT C2.8 55 kW (74 hp)  
**Tier 4F - power upgrade:**  
CAT C3.4 75 kW (100 hp)

## Transport dimensions

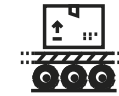

**Weight**  
11.4 t (25,000 lbs)  
**Width**  
2.5 m (8' 2")  
**Height**  
3.5 m (11' 3")  
**Length**  
15.8 m (51' 8")

**Weight**  
12.7 t (28,000 lbs)  
**Width**  
2.6 m (8' 5")  
**Height**  
3.5 m (11' 4")  
**Length**  
21.3 m (69' 9")



## Nordtrack™ CT85R & CT100R

# Heavy-duty tracked mobile stacking conveyors with radial movement

Made to deliver flexible, heavy-duty performance wherever you need it

Nordtrack™ CT85R and CT100R tracked stacking conveyors include wheels for radial movement and flexible positioning. The remote controlled crawler tracks make them agile and easy to move on-site and the added radial movement makes them an especially convenient alternative to wheel loaders.

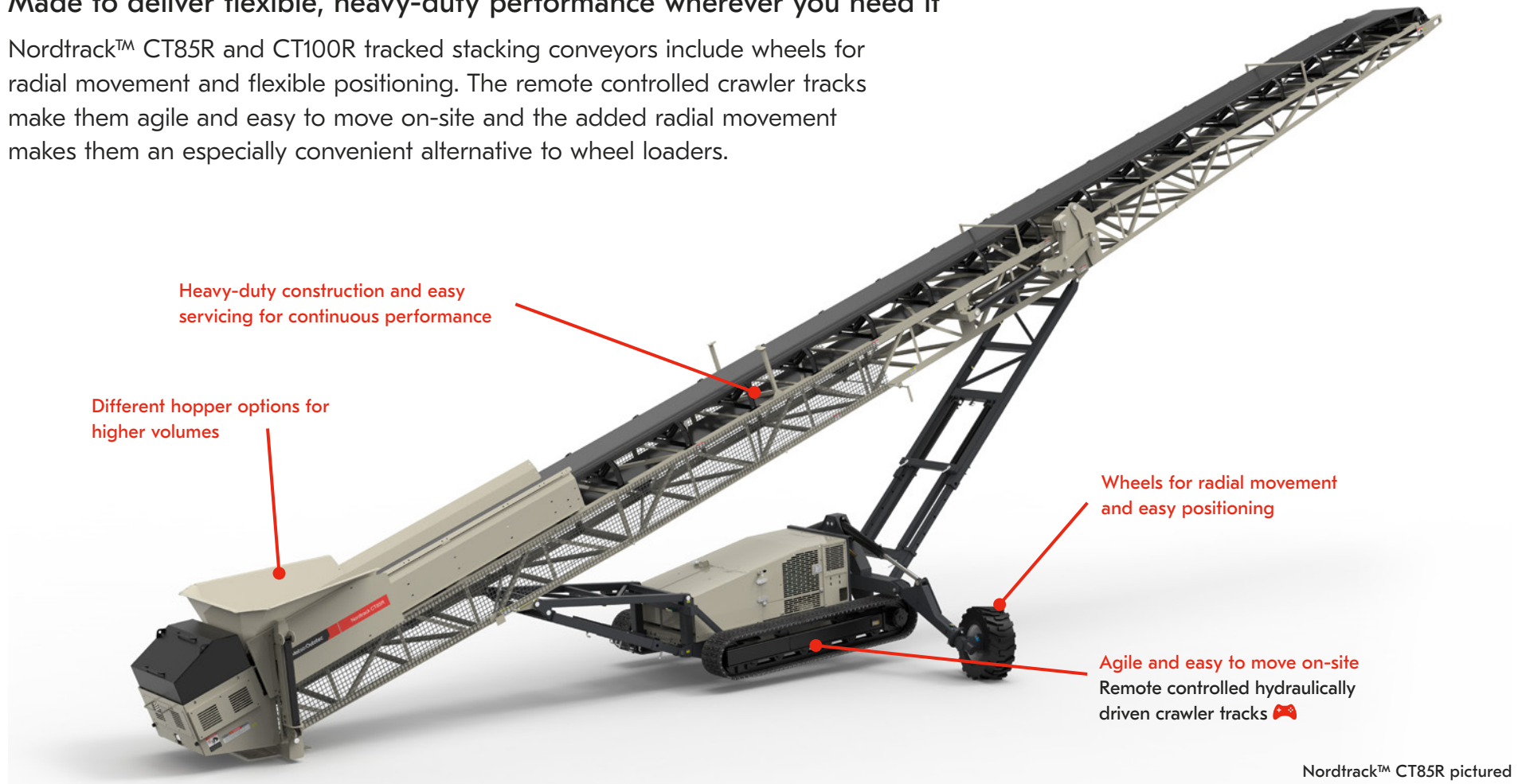

Heavy-duty construction and easy servicing for continuous performance

Different hopper options for higher volumes

Wheels for radial movement and easy positioning

Agile and easy to move on-site  
Remote controlled hydraulically driven crawler tracks 🎮

Nordtrack™ CT85R pictured  
Available only in North America



More cost-effective than wheel loaders



Mobile and easy to move on-site



Reduces traffic on-site for improved health and safety



Reliable, heavy-duty performance



# Technical details Nordtrack™ CT85R & CT100R

## Conveyor



### Nordtrack™ CT85R mobile stacking conveyor

**Belt length**  
24.4 m (80')

**Belt width**  
900 mm (36")

### Nordtrack™ CT100R mobile stacking conveyor

**Belt length**  
30.5 m (100')

**Belt width**  
900 mm (36")

## Capacity



**Hopper capacity**  
1.5 m<sup>3</sup> (2.0 yd<sup>3</sup>)

**Stockpile height**  
10.0 m (32' 10")

**Stockpile capacity**  
1,848 m<sup>3</sup> (2418 yd<sup>3</sup>)

**Hopper capacity**  
1.5 m<sup>3</sup> (2.0 yd<sup>3</sup>)

**Stockpile height**  
12.4 m (40' 7")

**Stockpile capacity**  
3,490 m<sup>3</sup> (4565 yd<sup>3</sup>)

## Drive options



### Diesel engine

#### Tier 4F:

CAT C2.2 37 kW (49 hp)

#### Tier 4F - power upgrade:

CAT C2.8 55 kW (74 hp)

### Diesel engine

#### Tier 4F:

CAT C2.8 55 kW (74 hp)

#### Tier 4F - power upgrade:

CAT C3.4 75 kW (100 hp)

## Transport dimensions



### Weight

12.5 t (27,500 lbs)

### Width

2.9 m (9' 4")

### Height

3.5 m (11' 3")

### Length

15.8 m (51' 8")

### Weight

13.7 t (30,200 lbs)

### Width

3.0 m (9' 8")

### Height

3.5 m (11' 4")

### Length

21.3 m (69' 9")



# Ease of operation



# Easy control

The entire Nordtrack™ series is designed with ease of use in mind. All Nordtrack machines can be operated safely and directly from the unit. In addition, all Nordtrack crushers come with crusher automation. Usability is further enhanced with remote controllers for the crawler tracks and other functions.

The built-in control panels in Nordtrack units give you direct control of all the equipment functions and hydraulics. In Nordtrack crushers, an automation panel is also included, which lets you control, monitor and troubleshoot every aspect of crusher operations.

With Nordtrack screens the units are controlled via user-friendly control panel and easy-to-use hand-levers. With the extra remote controller the operator can also control feeder functions remotely, like the tipping grid cleaning, from the excavator cabin.

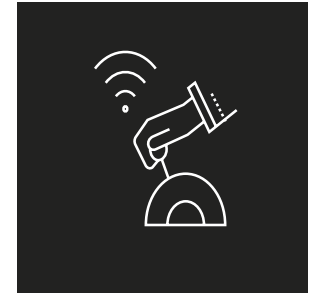



# Remote control crawler track operation

Nordtrack tracked equipment can be remote controlled using either wireless or wired controllers, ensuring that you are a safe distance from the moving machine, and giving you better visibility of the surrounding area. Nordtrack remote controls can be used with any Nordtrack product to easily steer the equipment around the work site.





# Fast service and support

The Nordtrack™ range comprises preconfigured, ready-to-ship products and a limited choice of well-defined options. This pre-designed approach makes them easy to order and quick to deliver. Nordtrack products are available through Metso and our worldwide network of distributors, and we can deliver them exactly where you need, when you need, with the support and parts you need, so you can be productive and profitable quickly.

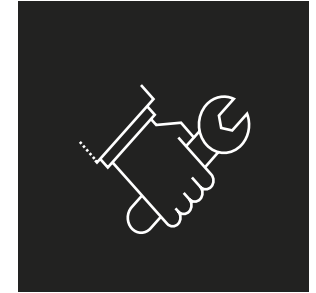

All Nordtrack products are supported through Metso Outotec and through our network of authorized Metso Outotec distributors with our expert service, technical support and genuine spare parts. All Nordtrack products are covered by Metso Outotec's standard warranty.

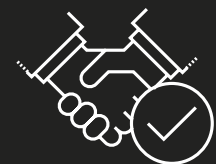

Metso Outotec is a frontrunner in sustainable technologies, end-to-end solutions and services for the aggregates, minerals processing and metals refining industries globally. By improving our customers' energy and water efficiency, increasing their productivity, and reducing environmental risks with our product and process expertise, we are the **partner for positive change**.



**FOR SALES ENQUIRIES, PLEASE  
CONTACT OUR AUSTRALIAN  
APPOINTED DISTRIBUTOR**

**TUTT BRYANT EQUIPMENT**

metso@tuttbryant.com.au  
1300 658 888

www.tuttbryant.com.au

**Metso:Outotec**

Metso Outotec, Lokomonkatu 3, P.O.Box 306, FI-33101 Tampere, Finland  
tel. +358 20 484 142, fax +358 20 484 143  
mogroup.com