

QUALITY CHANGES THE WORLD

**PRODUCT
SPECIFICATIONS**



STC250T4

**SANY TRUCK CRANE
25T LIFTING CAPACITY**



Max. Lifting Capacity: 25 t
Max. Boom Length: 35 m
Max. Lifting Moment: 1078 kN-m
315/80R22.5 Large Size Tires

www.sanyglobal.com

Right hand drive available

SANY TRUCK CRANE STC250T4 / 25T LIFTING CAPACITY

Strong boom

- 35m telescopic boom, Reach a new height of 35.5m.
- Larger cross-section boom, achieving a load moment of 1078KN·m.
- Boom section overlap increased, resulting in higher torsion resistance and bending resistance.
- 8m lattice jib, triangular structure for stable operation.



Powerful chassis

- DF Cummins ISLe290 30 engine, FAST 9-speed synchronizing gearbox, rubber suspension, 315/80R22.5 radial tires.
- Frame torsion resistance verified by 20k times of reliability and safety cycling test.
- Outrigger span expanded to 5.18m×6.4m (largest among this tonnage in the industry), stable base.
- Low deck carrier for drive stability.

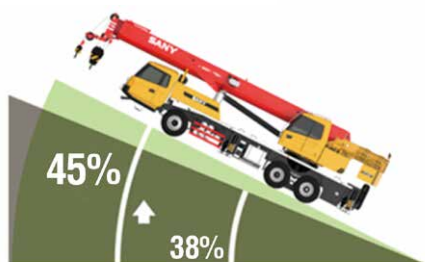



NY

△ NO STANDING UNDER THE BOOM

SANY

SANY TRUCK CRANE STC250T4 / 25T LIFTING CAPACITY



Precise hydraulics

- Load sensing hydraulic system: higher efficiency with less consumption.
- Constant-pressure powered luffing: smoothly luffing down, free from impact of load fluctuation.
- Big-flow piston slewing motor: slower slewing with larger torque.
- Power control: Engine speed reduced by 12% in operation, less fuel needed, less noise generated.



Mass-flow main valve



Bivariate piston pump



Luffing balance valve

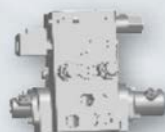

Slewing proportional valve



Winch motor



Winch balance valve





Length & angle indicator



Height limit switch



Danfoss
Pressure sensor



Smart I/O power distribution



Winch protector



Smart control

- CAN-BUS system: instant transfer of information, as fast as 20ms.
- Fault diagnosis: BCM controller for fault detection and easy maintenance.
- 7'color display & smart panel & IO power distribution: user friendly.
- Safety guarantee: SANY, Load Moment Indicator monitoring load and wire rope conditions.



Technical Features



5 ton hook block

Winch for easy loading

- Max. single line pull up to 5 ton. Freight within 5t can be loaded with a 5t auxiliary hook (standard configuration).
- Auxiliary hook block: wide opening with latch, safe and convenient.



Walking deck

- Abundant distance between deck and slewing platform to place outrigger sleeper.
- Ample space on deck tail to place sleepers.



Power and travel

- 300L fuel reservoir, 882km possible after every refuel.



Heat radiator

- Oil radiator mounted on the right of slewing platform, clear airflow and radiating.

Technical Features



Two cabs

- Ergonomic design gives you comfortable drive and operation.
- Wide view and multiple indicators for safe performance.



Counterweight

- Fixed 4.7t counterweight, high density with smaller size.

Overall Dimensions

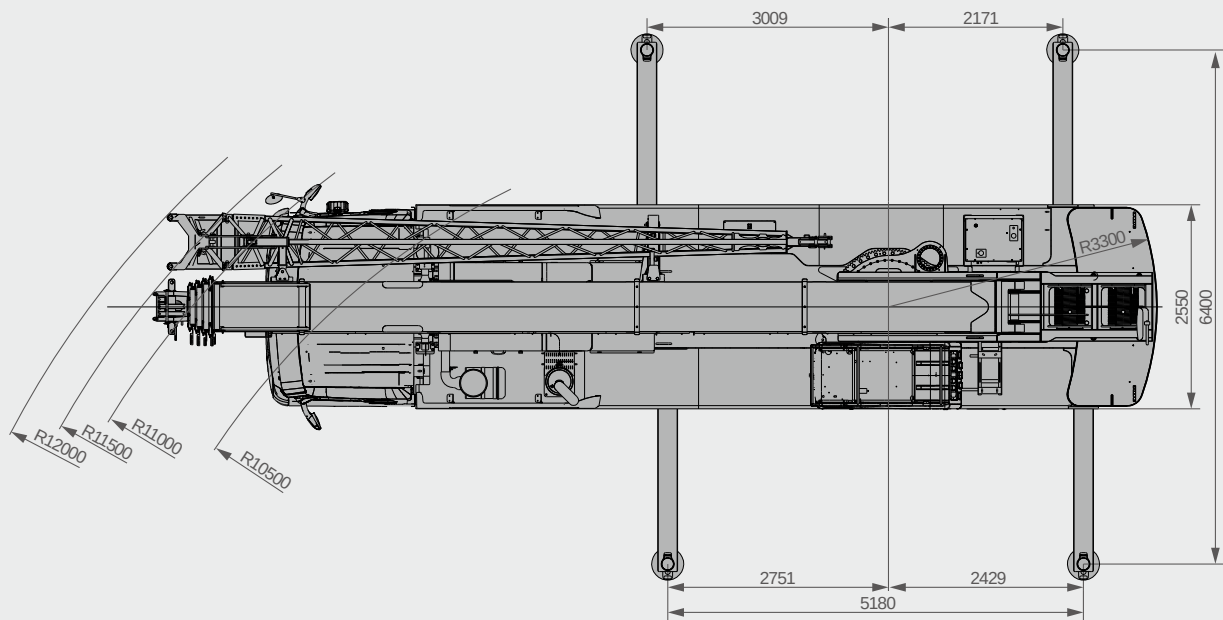
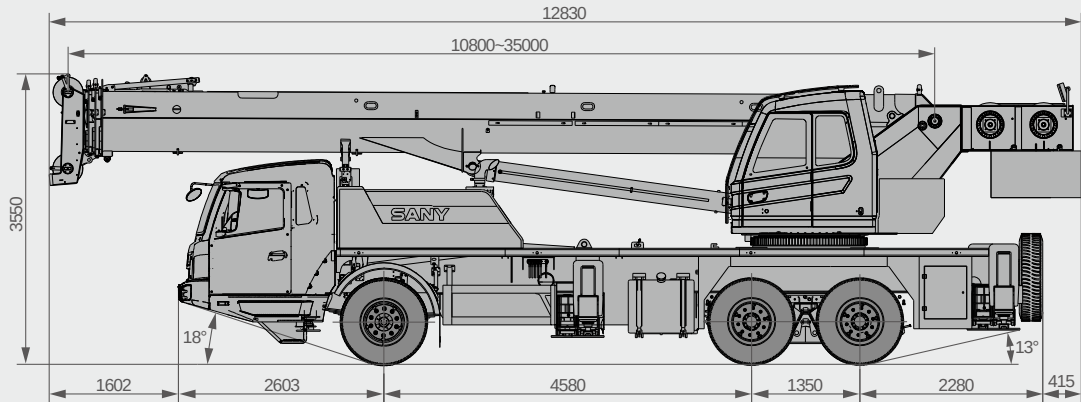

Technical Specification

CATEGORY	ITEM	UNIT	VALUE	
CAPACITY	Max. lifting capacity	t	25	
WEIGHT	Gross weight	kg	29650	
POWER	Engine model		ISLe290 30	
	Max. engine power	kW/rpm	213/2100	
	Max. engine torque	N·m/rpm	1050/(1200-1400)	
DIMENSIONS	Overall length	mm	12830	
	Overall width	mm	2550	
	Overall height	mm	3550	
	Axle base	Axle 1&2	mm	4580
		Axle 2&3	mm	1350
TRAVEL	Max.travel speed	km/h	90	
	Steering radius	Min.steering radius	m	10.5
		Min.steering radius of boom tip	m	12.5
	Min.ground clearance	mm	250	
	Approach angle	°	18	
	Departure angle	°	13	
	Max.gradeability	%	45	
	Fuel consumption per 100km	L	35	
	Working temperature range	°C	-20~+45	
	Min.rated lifting radius	m	3	
MAIN PERFORMANCE	Tail slewing radius	m	3.3	
	Boom sections (Qty.)		4	
	Boom shape		U-shape	
	Max.lifting moment	Basic boom	kN·m	1078
		Full-extend boom	kN·m	617
		Full-extend boom+jib	kN·m	356
	Boom length	Basic boom	m	10.8
		Full-extend boom	m	35
		Full-extend boom+jib	m	43
	Outrigger span (Longitudinal×Transverse)	m	5.18×6.4	
Jib offset	°	0,15,30		
OPERATION SPEED	Max.single rope lifting speed of main winch (empty load)	m/min	130	
	Max.single rope lifting speed of auxiliary winch (empty load)	m/min	130	
	Full extension / Retraction time of boom	s	55/45	
	Full luffing up / Down time of boom	s	45/55	
	Slewing speed	r/min	2.5	
AIRCONDITIONER	In operator's cab		Heating & Cooling	
	In driver's cab		Heating & Cooling	

Technical Parameters



Axle Load

Axle	1	2	3	Gross weight	Note
Axle load /kg	6930	11360	11360	29650	With jib
	6600	11350	11350	29300	Without jib

Remark: with main and aux. hooks, spare tire, half tank of fuel, and two persons.



Hook

Load/t	Number of sheaves	Rope rate	Hook weight /kg
25	4	8	320
5	-	-	85



Operations

Item	Rope diameter/length	Max. single line pull
Main winch	16mm/165m	4t
Auxiliary winch	16mm/95m	4t
Slewing		2.5r/min
Luffing up/down		45s/55s
Telescoping		55s/45s
Outrigger jack	Retract	30s
	Extend	15s
Outrigger beam	Retract	25s
	Extend	20s

Operating Range

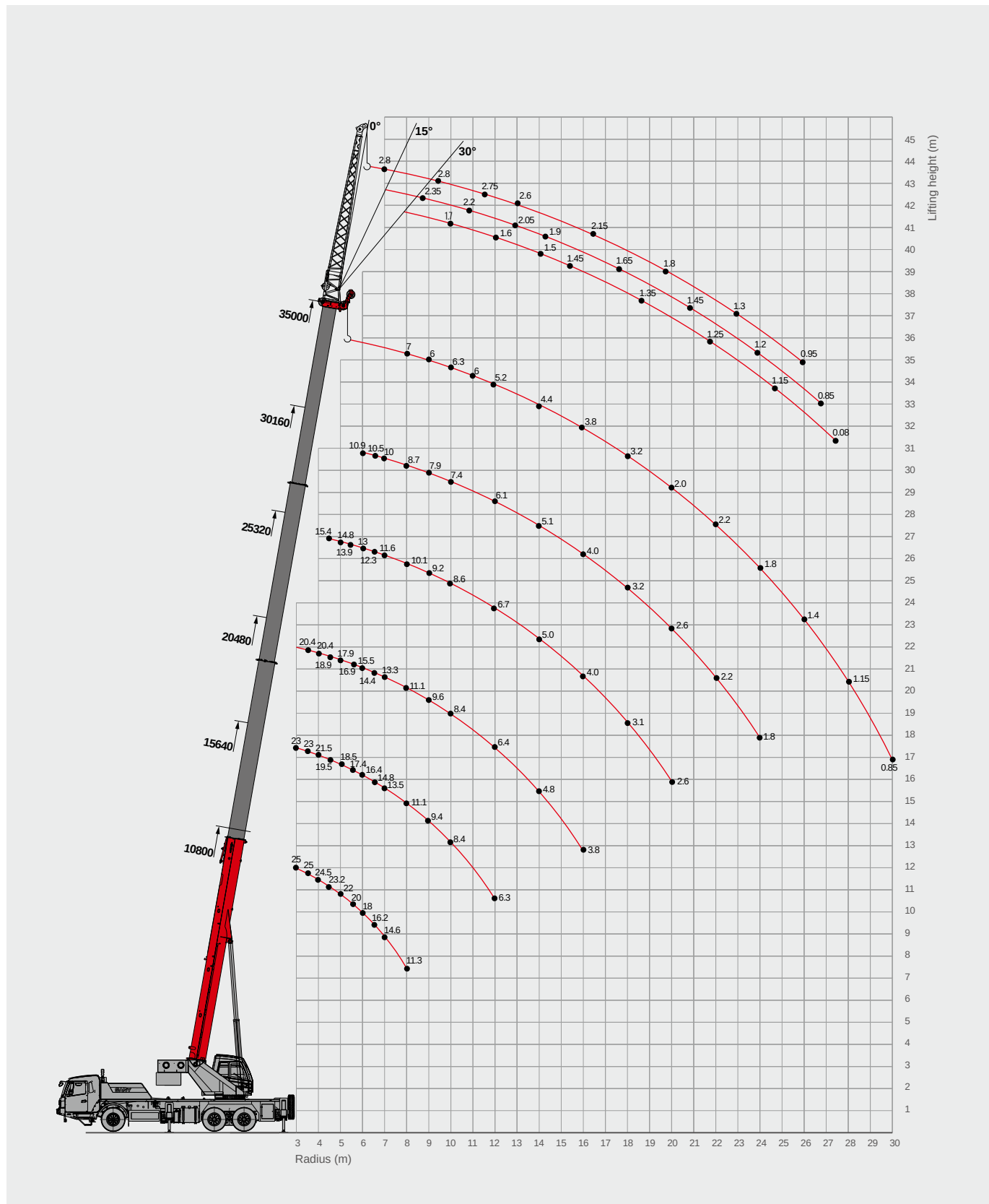

Load Chart-Telescopic Boom



Unit: kg

Radius (m)	10.8	15.6	20.5	25.3	30.2	35	Radius (m)
3	25000	23000					3
3.5	25000	23000	20400				3.5
4	24500	21500	20400				4
4.5	23200	19500	18900	15400			4.5
5	22000	18500	17900	14800			5
5.5	20000	17400	16900	13900			5.5
6	18000	16400	15500	13000	10900		6
6.5	16200	14800	14400	12300	10500		6.5
7	14600	13500	13300	11600	10000		7
8	11300	11100	11100	10100	8700	7000	8
9		9400	9600	9200	7900	6600	9
10		8400	8400	8600	7400	6300	10
12		6300	6400	6700	6100	5200	12
14			4800	5000	5100	4400	14
16			3800	4000	4000	3800	16
18				3100	3200	3200	18
20				2600	2600	2700	20
22					2200	2200	22
24					1800	1800	24
26						1400	26
28						1150	28
30						850	30
Rope rate	8	8	7	5	4	3	Rope rate

Load Chart-Jib



Unit: kg



Boom+Jib				
Boom angle	jib offset angle(°)			Boom angle
	0°	15°	30°	
78°	2800	2350	1700	78°
75°	2800	2200	1600	75°
72°	2750	2050	1500	72°
70°	2600	1900	1450	70°
65°	2150	1650	1350	65°
60°	1800	1450	1250	60°
55°	1300	1200	1150	55°
50°	950	850	800	50°

Remark:







- 1.Value listed are the max. capacity when the crane is in a level condition on solid ground or surface;
- 2.When the fifth outrigger is landed in position, value listed are applicable for 360 degree operation. In case of damage, avoid loading above carrier cab. Front operation is forbidden when the fifth outrigger is not working;
- 3.Value above are calculated with hooks and lifting slings considered (320kg main hook, 85kg auxiliary hook);
- 4.Radius refers to horizontal reach from hook center to slewing platform center;
- 5.Load value is given according to the larger radius or boom length value when the actual radius or boom length falls between two numbers above;
- 6.Lifting performance of boom point sheave equals that of 41m boom, while max. load shall be 5t;
- 7.Boom load capacity shall be 450kg less than value given when jib is mounted.

Hoisting Machinery







TRUCK CRANE

 SPC120T Max.lifting capacity:12T Full-extend boom: 31.2m Max.lifting moment: 510kN·m	 STC160 Max.lifting capacity:16T Full-extend boom: 32m Max.lifting moment: 730kN·m	 STC200S Max.lifting capacity:20T Full-extend boom: 33.5m Max.lifting moment: 880kN·m	 STC250-5 (CIS) Max.lifting capacity:25T Full-extend boom: 40.5m Max.lifting moment: 1029kN·m
 STC250T4 Max.lifting capacity:25T Full-extend boom: 35m Max.lifting moment: 1078kN·m	 STC250T5 Max.lifting capacity:25T Full-extend boom: 41m Max.lifting moment: 1063kN·m	 STC300S Max.lifting capacity:30T Full-extend boom: 40.5m Max.lifting moment: 1029kN·m	 STC300 Max.lifting capacity:30T Full-extend boom: 34.5m Max.lifting moment: 1120kN·m
 STC350T Max.lifting capacity:35T Full-extend boom: 42.5m Max.lifting moment: 1158kN·m	 STC450C5 (IN) Max.lifting capacity:45T Full-extend boom: 43.5m Max.lifting moment: 1666kN·m	 STC500T Max.lifting capacity:50T Full-extend boom: 44.5m Max.lifting moment: 2100kN·m	 STC600T Max.lifting capacity:60T Full-extend boom: 45.5m Max.lifting moment: 2100kN·m
 STC700T Max.lifting capacity:70T Full-extend boom: 48m Max.lifting moment: 2107kN·m	 STC800S Max.lifting capacity:80T Full-extend boom: 49m Max.lifting moment: 2958kN·m	 STC900T Max.lifting capacity:90T Full-extend boom: 50m Max.lifting moment: 3293kN·m	 STC1000S Max.lifting capacity:100T Full-extend boom:56m Max.lifting moment:3234kN·m

TRUCK-MOUNTED CRANE

 SPC250T3 Max.lifting capacity:25T Full-extend boom: 25.4m Max.lifting moment: 920kN·m	 SPC250T4 Max.lifting capacity:25T Full-extend boom: 33m Max.lifting moment: 920kN·m	 SPC320 Max.lifting capacity:32T Full-extend boom: 32m Max.lifting moment: 1020kN·m
 SPC400E Max.lifting capacity:40T Full-extend boom: 35m Max.lifting moment: 1372kN·m	 SPC400 Max.lifting capacity:40T Full-extend boom: 40.5m Max.lifting moment: 1400kN·m	 PSLM-25 (RU) Max.lifting capacity:25T Full-extend boom:32m Max.lifting moment:891kN·m

ROUGH-TERRAIN CRANE

































 SRC300(C)/(CR) Max.lifting capacity:30T Full-extend boom: 31.5m Max.lifting moment: 976 / 968kN·m	 SRC400C Max.lifting capacity:40T Full-extend boom: 31.5m Max.lifting moment: 1175kN·m	 SRC600C Max.lifting capacity:60T Full-extend boom:43.5m Max.lifting moment:2115kN·m
 SRC750 Max.lifting capacity:75T Full-extend boom: 45m Max.lifting moment: 2529kN·m	 SRC900C Max.lifting capacity:90T Full-extend boom: 47m Max.lifting moment: 2820kN·m	 SRC1200 Max.lifting capacity:120T Full-extend boom:49m Max.lifting moment:3658kN·m

ALL-TERRAIN CRANE















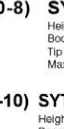
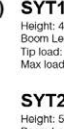
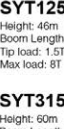

 SAC1100S Max.lifting capacity:110T Full-extend boom: 63m Max.lifting moment: 4145kN·m	 SAC1300S Max.lifting capacity:130T Full-extend boom: 63m Max.lifting moment: 4547kN·m	 SAC1600S Max.lifting capacity:160T Full-extend boom:73m Max.lifting moment:5174kN·m
 SAC1800 Max.lifting capacity:180T Full-extend boom: 62m Max.lifting moment: 6320kN·m	 SAC2200 Max.lifting capacity:220T Full-extend boom: 62m Max.lifting moment: 6800kN·m	 SAC2200S Max.lifting capacity:220T Full-extend boom: 68m Max.lifting moment: 6800kN·m
 SAC2500S Max.lifting capacity:250T Full-extend boom: 73m Max.lifting moment: 7271kN·m	 SAC3000S Max.lifting capacity:300T Full-extend boom: 81m Max.lifting moment: 9900kN·m	 SAC3500S Max.lifting capacity:350T Full-extend boom: 70m Max.lifting moment: 11520kN·m
 SAC4500S Max.lifting capacity:450T Full-extend boom: 84m Max.lifting moment: 14570kN·m	 SAC6000 Max.lifting capacity:600T Full-extend boom: 90m Max.lifting moment: 18228kN·m	

Hoisting Machinery

HOISTING MACHINERY CRAWLER CRANE

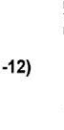
 SCC450A Max lifting capacity: 45T Max Length of Boom: 40m Max Length of Fixed jib: 15.25m Max lifting moment: 150t.m	 SCC550A Max lifting capacity: 55T Max Length of Boom: 52m Max Length of Fixed jib: 15.25m Max lifting moment: 203.5t.m	 SCC600A Max lifting capacity: 60T Max Length of Boom: 52m Max Length of Fixed jib: 15.25m Max lifting moment: 222t.m	 SCC750A Max lifting capacity: 75T Max Length of Boom: 57m Max Length of Fixed jib: 18m Max lifting moment: 268t.m	 SCC4000A Max lifting capacity: 400T Max Length of Boom: 84m Max Length of Fixed jib: 12m Max Length of Luffing jib: 84m Max lifting moment: 5500t.m	 SCC5000A Max lifting capacity: 500T Max Length of Boom: 84m Max Length of Fixed jib: 12m Max Length of Luffing jib: 84m Max lifting moment: 6160t.m	 SCC6500A Max lifting capacity: 650T Max Length of Boom: 108m Max Length of Fixed jib: 12m Max Length of Luffing jib: 96m Max lifting moment: 8600t.m	 SCC8000A Max lifting capacity: 80T Max Length of Boom: 99m Max Length of Fixed jib: 15m Max Length of Luffing jib: 96m Max lifting moment: 12016t.m	 SCC250TB Max lifting capacity: 25T Max Length of Boom: 42.5m Max Length of Fixed jib: 8m Max lifting moment: 117.6t.m	
 SCC800A Max lifting capacity: 80T Max Length of Boom: 57m Max Length of Fixed jib: 18m Max lifting moment: 360t.m	 SCC850A Max lifting capacity: 85T Max Length of Boom: 57m Max Length of Fixed jib: 18m Max lifting moment: 360t.m	 SCC900A Max lifting capacity: 90T Max Length of Boom: 61m Max Length of Fixed jib: 18m Max lifting moment: 360t.m	 SCC1000A Max lifting capacity: 100T Max Length of Boom: 64m Max Length of Fixed jib: 18m Max lifting moment: 360t.m	 SCC350TB Max lifting capacity: 35T Max Length of Boom: 31.5m Max Length of Fixed jib: 13.7m Max lifting moment: 117m	 SCC400TB Max lifting capacity: 40T Max Length of Boom: 35m Max Length of Fixed jib: 16m Max lifting moment: 150t.m	 SCC550TB-1 Max lifting capacity: 55T Max Length of Boom: 42m Max Length of Fixed jib: 13m Max lifting moment: 216t.m	 SCC800TB Max lifting capacity: 80T Max Length of Boom: 47m Max Length of Fixed jib: 17.5m Max lifting moment: 300t.m	 SCC800HD Max lifting capacity: 80T Max Length of Boom: 55m Max lifting moment: 350t.m	
 SCC1350A Max lifting capacity: 135T Max Length of Boom: 76m Max Length of Fixed jib: 31m Max lifting moment: 658t.m	 SCC1350A-1 Max lifting capacity: 135T Max Length of Boom: 76m Max Length of Fixed jib: 31m Max lifting moment: 668t.m	 SCH1500A Max lifting capacity: 150T Max Length of Boom: 76m Max Length of Fixed jib: 31m Max lifting moment: 752t.m	 SCC1500A-1 Max lifting capacity: 150T Max Length of Boom: 76m Max Length of Fixed jib: 31m Max lifting moment: 850t.m	 SCC1500D Max lifting capacity: 150T Max Length of Boom: 81m Max Length of Fixed jib: 31m Max lifting moment: 900t.m	 SCE600A Max lifting capacity: 60T Max Length of Boom: 52m Max Length of Fixed jib: 15.25m Max lifting moment: 225t.m	 SCA1000A/ Max lifting capacity: 100T Max Length of Boom: 64m Max Length of Fixed jib: 22.5m Max lifting moment: 360t.m	 SCE1350A Max lifting capacity: 135T Max Length of Boom: 76m Max Length of Fixed jib: 31m Max lifting moment: 668t.m	 SCA2600A Max lifting capacity: 26T Max Length of Boom: 92m Max Length of Fixed jib: 42m Max Length of Luffing jib: 63m Max lifting moment: 1470.4t.m	 SCE800TB Max lifting capacity: 80T Max Length of Boom: 55m Max Length of Fixed jib: 17.5m Max lifting moment: 300t.m
 SCC1800 Max lifting capacity: 180T Max Length of Boom: 85m Max Length of Fixed jib: 31m Max lifting moment: 1056t.m	 SCC2000A Max lifting capacity: 200T Max Length of Boom: 85m Max Length of Fixed jib: 31m Max lifting moment: 1152t.m	 SCC2600A Max lifting capacity: 260T Max Length of Boom: 85m Max Length of Fixed jib: 42m Max Length of Luffing jib: 63m Max lifting moment: 1470.4t.m	 SCC2800A Max lifting capacity: 280T Max Length of Boom: 86m Max Length of Fixed jib: 42m Max Length of Luffing jib: 63m Max lifting moment: 1620t.m	 SCC3500A Max lifting capacity: 350T Max Length of Boom: 84m Max Length of Fixed jib: 42m Max Length of Luffing jib: 84m Max lifting moment: 4695t.m					

TOWER CRANE

 SYT63(T5013-5) Height: 40.5m Boom Length: 50m Tip load: 1.3T Max load: 5T	 SYT80(T5710-6) Height: 40.5m Boom Length: 57m Tip load: 1T Max load: 6T	 SYT80(T6012-6) Height: 40.5m Boom Length: 60m Tip load: 1.2T Max load: 6T	 SYT80(T6510-6) Height: 43m Boom Length: 65m Tip load: 1T Max load: 6T	 SYT80(T6510-8) Height: 43m Boom Length: 65m Tip load: 1T Max load: 8T
 SYT80(T6013-6) Height: 46m Boom Length: 60m Tip load: 1.3T Max load: 6T	 SYT100(T6510-8) Height: 44.8m Boom Length: 65m Tip load: 1T Max load: 8T	 SYT100(T6515-6) Height: 46m Boom Length: 65m Tip load: 1.5T Max load: 6T	 SYT125(T6510-8) Height: 44.8m Boom Length: 65m Tip load: 1T Max load: 8T	 SYT125(T6515-8) Height: 46m Boom Length: 65m Tip load: 1.5T Max load: 8T
 SYT125E2(T6515-8) Height: 60m Boom Length: 65m Tip load: 1.5T Max load: 8T	 SYT160(T7015-10) Height: 60m Boom Length: 70m Tip load: 1.5T Max load: 10T	 SYT250(T7525-16) Height: 51m Boom Length: 75m Tip load: 1.5T Max load: 16T	 SYT250(T7527-12) Height: 51m Boom Length: 75m Tip load: 2.5T Max load: 12T	 SYT315(T7530-16) Height: 60m Boom Length: 75m Tip load: 2.7T Max load: 16T
 SFT100(T6013-8) Height: 45m Boom Length: 60m Tip load: 1.3T Max load: 8T	 SFT160(T7015-10) Height: 60m Boom Length: 70m Tip load: 1.5T Max load: 10T	 SLT160(T5523-12) Height: 45m Boom Length: 55m Tip load: 1.3T Max load: 2T	 SLT260(T5531-18) Height: 52m Boom Length: 55m Tip load: 3.1T Max load: 18T	
 SFT258(T7021-12) Height: 60m Boom Length: 70m Tip load: 2.1T Max load: 12T	 SFT321(T7526-16) Height: 60m Boom Length: 75m Tip load: 2.6T Max load: 16T			



SANY GROUP CRANE BU

SANY Mobile Crane Industrial Park, No.168 Jinzhou Avenue, Jinzhou Development Zone, Changsha City, Hunan Province, P.R. China Zip 410600

Consulting sanycrane@sanygroup.com (Crane BU) / crd@sany.com.cn (IHQ)

After-sales Service 0086-400 6098 318

Reminder:

Any change in the technical parameters and configuration due to product modification or upgrade may occur without prior notice. The machine in the picture may include additional equipment. This brochure is for reference only, and goods in kind shall prevail.

Copyright at SANY. No part of this brochure may be copied or used for any purpose without written approval from SANY.

© Edited in January 2022

