



# SCC3500A

## Crawler Crane 350 Tons Lifting Capacity

Quality Changes the World



**Max. lifting capacity: 350t**

**Max. lifting moment without/with superlift: 2359/4699t·m**

**Max. boom length (with superlift): 84m**

**Max. fixed jib combination: 66m+42m**

**Max. luffing jib combination (with superlift): 84m+84m**

The parameters and diagrams in the brochure is only for reference, which is subject to further update in real machine.

■ [www.sany.com.cn](http://www.sany.com.cn)



**Crawler Crane Series**  
**SCC3500A**

P03

Main Characteristics

- Product Specification
- Safety Devices

P10

Technical Parameters

- Major Performance Specifications
- Outline Dimension
- Transport Plan
- Self-assembly plan

P30

Cofigurations

- Configurations
- H Configuration
- HDB Configuration
- HJ Configuration
- HJDB configuration
- FJ configuration
- LJ Configuration
- LJDB Configuration
- Shield Configuration



**SCC3500A**  
**SANY CRAWLER CRANE**  
**350 TONS LIFTING CAPACITY**

QUALITY CHANGES THE WORLD

## Main Characteristics

- Page 04 Product Specification
- Page 08 Safety Devices



## Product Specification



### Engine

- Model: Cummins QSM11-C400 Diesel engine;
- Type: 4-stroke, water-cooled, vertical in-line 6 cylinders, direct injection, turbo-charger, intercooler, complied with European Off-way Tier III Emission Standard and Chinese Off-way Tier III Emission Standard;
- Displacement: 10.8L;
- Rated power: 298kW/1800rpm;
- Max. Torque: 1898N·m/1400rpm;
- Starter: 24V-8.0kW;
- Radiator: fin type aluminum plate core;
- Air cleaner: Dry type system with main filter element, safety element and resistance indicator;
- Throttle: Grip type hand throttle, electrically-controlled;
- Fuel filter: Replaceable paper element;
- Batteries: Two 12V×180Ah capacity batteries, connected in series;
- Fuel tank capacity: 900L.

### Electrical Control System

- Self-developed SYIC-II integrated control system is adopted with higher integration, precise operation and reliable quality;
- Control system consists of power system, engine system, main control system, LMI system, auxiliary system and safety monitoring system. CAN BUS is used for data communication between controller, monitor and the engine;
- Monitor: the working parameters and status are shown on the monitor, such as the engine speed, fuel volume, engine oil pressure, servo pressure, wind speed, engine working hours, LMI data, ground bearing pressure, control handle function, alarm information, failure self-diagnosis;
- Remote Monitoring System: newly developed APP can collect equipment status at any time anywhere. Online functions such as smart maintenance reminder, failure alarm, construction data feeding, one-click service request, equipment health management are available, which makes the information more transparent and instant;
- Remote Control System: all main mechanisms and assisting cylinders can be controlled through remote control box as an optional feature. The monitor can show data of engine and LMI to ensure smarter, easier and safer operation.

### Hydraulic System

- Main pumps: open variable displacement piston pumps are adopted to provide oil supply for main actuators of main machine;
- Gear pump: one dual-gear pump for oil radiator motor and A/C motor control circuit;
- Control: main pump adopts load sensitive control; winch motor adopts limitless adjustable piston motor of variable displacement. The operating components are two one-way electrical control handle, one dual-travel electrically-controlled pedal to control various actuators proportionally;
- Way of cooling: air-cooled heat exchanger, fan core and multi-stage cooling;
- Filter: large flow, high precision filter, with bypass valve and transmitter, which can remind the user to replace the filter element in time;
- Max. pressure of system:
- Main/aux. load hoist, boom/jib hoist, swing and travel system: 33Mpa;
- Servo pressure: 3.5 MPa;
- Hydraulic Tank Capacity:815L.



## Product Specification

### Main and Aux. Load Hoist Mechanism

- A variable hydraulic motor drives the planetary gear reducer to control the load lifting and lowering of main hoist winches. A good inching performance is provided. The high-speed mode can realize main and aux. load lifting faster;
- Variable hydraulic motor can realize max. winch speed through automatic adjustment based on load;
- Choose high-quality spin-resistance wire rope to make sure high safety and longer service life;
- Fold-line machined drum provides high precision and good reliability, making sure the wire rope won't get messy;
- Choose the wire rope lug to make wire rope assembly easier and faster.

Main Load Hoist Mechanism	Drum diameter	630mm
	Rope speed on the outermost work layer	0~140m/min
	Wire rope diameter	28mm
	Wire rope length for main load hoist winch	800m
	Rated single line pull	17t
Auxiliary Load Hoist Mechanism	Drum diameter	630mm
	Rope speed on the outermost work layer	0~140m/min
	Wire rope diameter	28mm
	Wire rope length for aux. load hoist winch	450m/800m
	Rated single line pull	17t

### Boom/Jib/Superlift Hoist Mechanism

- Including: boom hoist mechanisms, jib hoist mechanism, superlift luffing mechanism;
- Drums with folded-line grooves are adopted for all luffing devices. Hydraulic motor drives the planetary gear reducer to realize multiple composite actions and it is equipped with good inching performance.

Boom Hoist Mechanism	Drum diameter	641mm
	Rope speed on the outermost work layer	(0~65)×2m/min
	Wire rope diameter	26mm
	Wire rope length of boom hoist winch	550m
Jib Hoist Mechanism	Drum diameter	641mm
	Rope speed on the outermost work layer	0-100m/min
	Wire rope diameter	26mm
	Wire rope length of jib luffing winch	660m
Superlift luffing Mechanism	Drum diameter	641mm
	Rope speed on the outermost work layer	0-100m/min
	Wire rope diameter	26mm
	Wire rope length of superlift luffing winch	860m

### Swing Mechanism

- Swing brake adopts wet, spring loaded, normally-closed brake, and braking through spring force;
- Swing system adopts closed system with free slipping function. It is featured in steady starting and control, and excellent inching function;
- Swing drive: external engaged swing drive with 360° swing range, and the max. swing speed is 1.5r/min. The max. drive pressure can reach 30MPa;
- Swing lock: cylinder lock can ensure the upperworks locked securely after work or during transport;
- Swing ring: three-row roller bearing.

## Product Specification



### Cab and Control

- Novel operator's cab with fashionable profile, nice interior and large window glass, which can tilt up by 20° to provide panorama view. There are low and high-beam lights, back-view mirror, heater and A/C, radio and other functions. The layout of seat, handles, control buttons are designed with ergonomic principles to make operation more comfortable;
- Cab layout: Integrated 10.4-inch touch screen, two monitors, standard vibration handle, and man-machine interaction interface are more improved;
- Armrest box: on the left and right armrest box are control handles, electrical switches, emergent stop and ignition switch. The armrest box can be adjusted along with the seat;
- Seat: multi-way and multi-level floating adjustable seat with unload switch;
- A/C: cool and heat air; optimized air channels and vents;
- Multiple cameras can present on the monitor at the same time to realize backing video, real-time monitoring of hook working, travel area, winch and wire rope reeving conditions.

### Counterweight

- Include Carbody Counterweight, Rear Counterweight and Superlift Counterweight.

Name	Quantity	Length	Width	Height	Unit weight
Center counterweight	4	5.8	1.96	0.37	10
Rear Counterweight	16	2.68	2.38	0.49	8
Rear counterweight tray	1	8.06	2.68	0.49	12
Superlift counterweight	19	2.49	2.35	0.54	10
Superlift counterweight tray	1	9.95	2.7	1.8	10.7

### Upperworks

- High-strength steel weld framework, with no torsion or deformation. The parts are laid out in the way that is easier for maintenance and service.

### Carbody

- The hydraulic cylinder drives power pin to be connected with track frame to facilitate the assembly and disassembly. Frame structures are welded by high-strength steel. Larger carbody design greatly improves the stability of the crane. The carbody counterweight is 40t, 20t each in front and back and can be self-assembled.

### Crawler Assembly

- Track frame: each track frame is equipped with an independent travel driving device. A hydraulic travel motor drives the planetary gear reducer and realizes independent traveling through the transmission of driving wheel. The travel system is configured with low and high speed options: sufficient traction is provided in low speed to realize 100% pick and carry, while faster job-site transfer is possible in high travel speed. Infinite variable speed can be realized in travel driving system;
- Track shoe: it is manufactured by advanced casting techniques and materials with high strength and good wear resistance. After assembled on the machine, the tension can be adjusted by a hydraulic jack with shims used to secure the crawler position.

### Operating Weight

- The operating weight is about 333t, including the Upperworks, lowerworks, rear counterweight of basic machine, center counterweight, 24m basic boom and 350t hook block.

### Ground Bearing Pressure

- The average ground pressure of machine with basic boom is 0.16MPa.

### Gradeability

- The gradeability of the machine with basic boom is 15%.



## Product Specification

### Operating Equipment

- All operating equipment adopt high-strength steel pipe, so do the steel plates. The sheaves used on boom/jib tip and hooks are all rolled material and welded structure.

### Boom

- The boom is a spatial lattice structure with equal section areas for inserts and tapered section areas for both ends. With tubes welded together, and boom tip and root strengthened with steel plates, it can better transfer the load;
- The length of the boom ranges from 24m base boom to the maximum length 84m;
- Composition: boom base 12m×1, transitional insert 10.5m×1, connection tip 1.5m×1, insert section 6m×2 and insert 12m×4. The extension jib is installed onto the boom connection tip.

### Fixed Jib

- The fixed jib is a spatial lattice structure with equal section areas for inserts and tapered section areas for both ends. With tubes welded together, and boom tip and root strengthened with steel plates, it can better transfer the load;
- The length of fixed jib sections are 9m, Between 12m and 42m, the boom length increases every 6m;
- Composition: jib base 4.5m×1, jib insert 3m×1 and 6m×1, and insert 12m×2 and jib top 4.5m×1.

### Luffing Jib

- The luffing jib is a spatial lattice structure with equal section areas for inserts and tapered section areas for both ends. With tubes welded together, and boom tip and root strengthened with steel plates, it can better transfer the load;
- The length of luffing jib sections vary from 24m to 84m, incremental in every 6m;
- Composition: jib base 10.5m×1, tapered insert 6m×1, insert 6m×2, insert 12m×4, jib top 7.5m×1; The extension jib is installed onto the boom connection tip.

### Superlift Mast

- The superlift mast is a spatial lattice structure with equal section areas for inserts and tapered section areas for both ends. With tubes welded together, and boom tip and base strengthened with steel plates, it can better transfer the load;
- The length of superlift mast is 30m;
- Composition: superlift base 12m×1, insert 6m×1, and mast top 12m×1.

### Hook

- There are six types of hook blocks are available:

Name of Hook Block	Max. load weight	QTY	No. of sheaves	Unit weight (t)
350t hook block	350	1	13	6.8
260t hook block	260	1	9	5.2
160t hook block	160	1	5	3
50t hook block	50	1	1	1.7
16t ball hook	16	1	None	0.9

## Safety Devices



### Load Moment Indicator

- The proprietary load moment indicator is independently-developed by Sany, and connected with other controller through CAN BUS to realize safe and reliable control. The Load Moment Indicator can automatically detect the load weight and boom angle, and display the rated load capacity, actual work radius and allowable hook height;
- The LMI system consists of large screen color monitor, host machine, angle sensors, tension sensors and pressure sensors.

### Over-hoist Protection of the Main and Auxiliary Load Hooks

- It is used to prevent the over-hoist of the hook. When the lifting hook is raised to a certain height, the limit switch will start working, and hook will be automatically cut off from moving up by the control system. Meanwhile, the display and the buzzer will give alarms. At this moment, only hook lowering is allowed to prevent over-hoist action.

### Over-release Protection Device of the Main and Auxiliary Load Hook

- It is used to prevent the wire rope over-release. When the wire rope is released to the last three wraps, the limit switch will start working, and the releasing of rope will be automatically stopped by the control system. Meanwhile, the display and the buzzer will give alarms. At this moment, only rope retraction is allowed to prevent over release action.

### Assembly/Work Mode Switch

- In assembly mode, some of the safety devices are ineffective for helping crane assembly, for example, jib lower limit, LML boom angle limit and overload.
- In work mode, all safety devices can work.

### Crane boom/jib limit device

- When the elevation angle of the boom exceeds 85° and jib angle exceeds 75°, corresponding limit switch will be triggered, and the control system will automatically cut off the boom hoisting. Meanwhile, the display and the buzzer will give alarm. At this moment, boom/jib hoist winch won't hoist but it can still lower down.
- When the boom down angle is less than 30° or jib down angle is less than 15°, the control system will automatically cut off the boom/jib from further lowering. Meanwhile, the display and the buzzer will give alarms. At this moment, boom/jib hoist winch won't be able to lower. This protection is automatically controlled by Load Moment Indicator.

### Back-stop Device

- The boom and the superlift luffing mast are respectively equipped with a pair of back-stop cylinders. The high pressure of the cylinder shall be overcome when the boom tilts backwards, and high pressure oil will be supplemented automatically when the boom swings forwards and increase the tension, so as to prevent the boom vibration and backlash. The jib fixed strut is equipped with back-stop cylinders and jib luffing strut is equipped with a pair of hydraulic pneumatic cylinder to prevent mast tipping back and tension the jib luffing wire rope.

### Hoisting Mechanism Brake

- All hoisting brakes are spring loaded normally closed disc brakes, which are featured with large braking force, maintenance-free, safe and reliable use, and long service life.





## Safety Devices

### Closed Circuit Monitoring System

- The monitoring system can display the wire rope reeving on each hoisting winch, superlift counterweight and conditions around the machine.

### Fault Auto-Diagnosis System

- Faults can be conveniently eliminated based on the fault code.

### Black box

- It is able to record the operation data and machine movement, and analyze the remaining running conditions and service life of machine based on the actual performance.

### Pharos

- It is mounted on the top of the boom/jib and alerts in air during night.

### Anemometer

- It is mounted on the top of the boom/jib to monitor the wind speed in real time and display relative data on the monitor.

### Electronic Level Indicator

- It displays the tilting angle of the crane on the monitor in real time and protects the safe operation of the crane.

### Lightning Protection Device

- It includes the lightning protection device and the surge protection device, which can effectively protect the electric system elements and workers from lightning.

### Boom Angle Indicator

- It is a pendulum-type angle indicator fixed on one side of the boom base.

### Hook Latch

- The lifting hook is installed with a baffle plate to prevent wire rope from falling off.

### Swing and Traveling Alarm

- During swing and traveling, the alarm horn will be blown per certain frequency to alert the personnel around the crane.

### Function Lock

- The operation will be locked by pulling up the function locking lever on the right side of the seat inside the driver's cab or when the operator left the seat, after which no operating handles will be working so that improper operation caused by the body collision when getting on and off the crane can be avoided.

### Regulation of Engine Power Ultimate Load and Stalling Protection

- The controller can monitor the engine power so as to prevent stalling.

### Engine Status Monitor

- The engine coolant temperature, fuel volume, accumulated work hours, engine oil pressure, engine speed, battery status and voltage are monitored.

### Remote Monitoring System

- It monitors and analyzes the operation data so as to realize remote diagnosis of faults and timely solution.

### Emergency Stop Button

- Press down the Emergency Stop Button if the crane suddenly out of control, the load hoist, boom/jib hoist, slewing and traveling will all brake immediately and the machine stops.



**SCC3500A**  
**SANY CRAWLER CRANE**  
**350 TONS LIFTING CAPACITY**

QUALITY CHANGES THE WORLD

## Technical Parameters

- Page 11 Major Performance Specifications
- Page 12 Outline Dimension
- Page 21 Transport Plan
- Page 23 Self-assembly plan

> 10

## Major Performance Specifications

Major Performance & Specifications of SCC3500A		
Performance Indicators	Unit	Parameter
Max. rated lifting capacity	t	350
Max. rated lifting moment	t·m	2359
Max. rated lifting moment (with superlift)	t·m	4699
Boom length (H)	m	24 ~ 84
Boom length (with superlift) (HDB)	m	36 ~ 84
Length of mixed boom (HJ)	m	48 ~ 102
Length of mixed boom (with superlift) (HJDB)	m	72 ~ 126
Length of luffing jib (LJ)	m	24 ~ 72
Length of luffing jib (with superlift) (LJDB)	m	24 ~ 84
Combination of longest boom+jib (LJDB)	m	84+84
Fixed jib length (FJ)	m	9 ~ 42
Boom + fixed jib (FJH shield configuration)	m	24+9
Boom + fixed jib (FJ longest)	m	66+42
Angle of boom luffing	°	30 ~ 85
Angle of jib luffing	°	15 ~ 75
Max. speed of single rope of the main load hoist	m/min	0 ~ 140
Max. speed of single rope of the auxiliary load hoist	m/min	0 ~ 140
Max. speed of single rope of the boom hoist	m/min	(0 ~ 65)×2
Max. speed of single rope of the jib hoist	m/min	0 ~ 100
Max. speed of single rope of the superlift luffing	m/min	0 ~ 100
Slewing speed (no load)	r/min	0 ~ 1.5
Travel speed	km/h	0 ~ 1 (high)/0 ~ 0.35(low)
Gradeability (with base boom, cab facing backwards)	%	15
Rated output power of the engine	kW/rpm	298/1800
Average ground pressure of the track (base boom, 140t rear counterweight, 40t carbody weight, and 320t hook)	MPa	0.167
Max. single piece transport dimensions (L × W × H)	mm	12000×3000×3250
Max. single piece transport weight	t	44.9

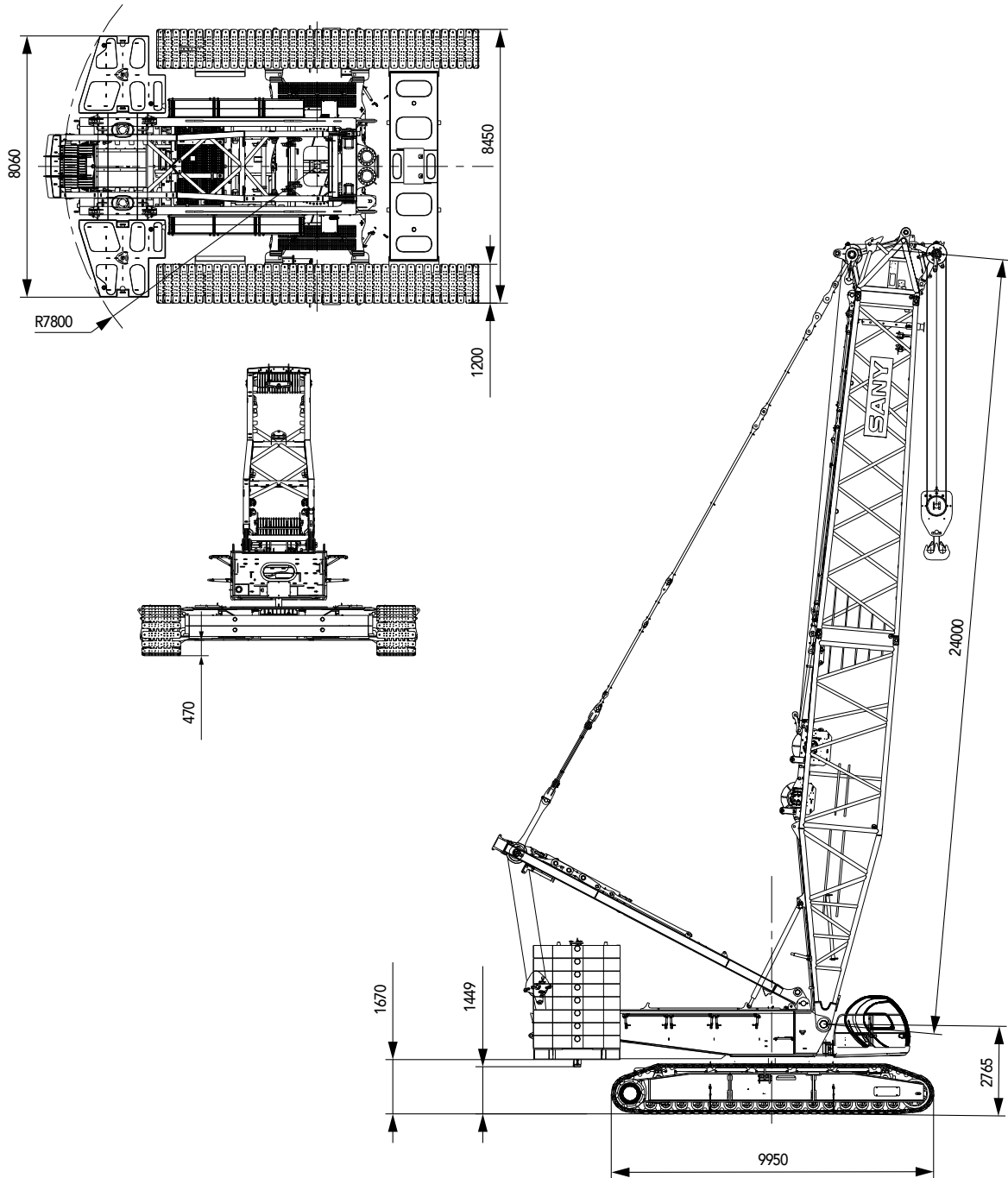
**Outline Dimension**

Unit: mm

### Outline Dimension

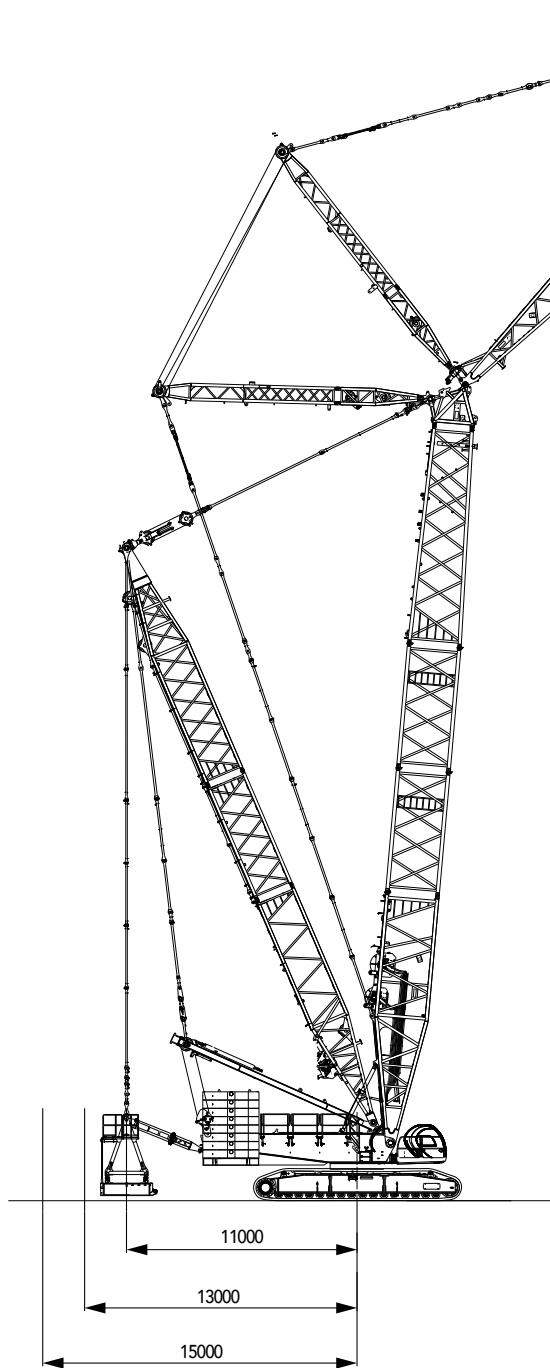

## Transport Dimension

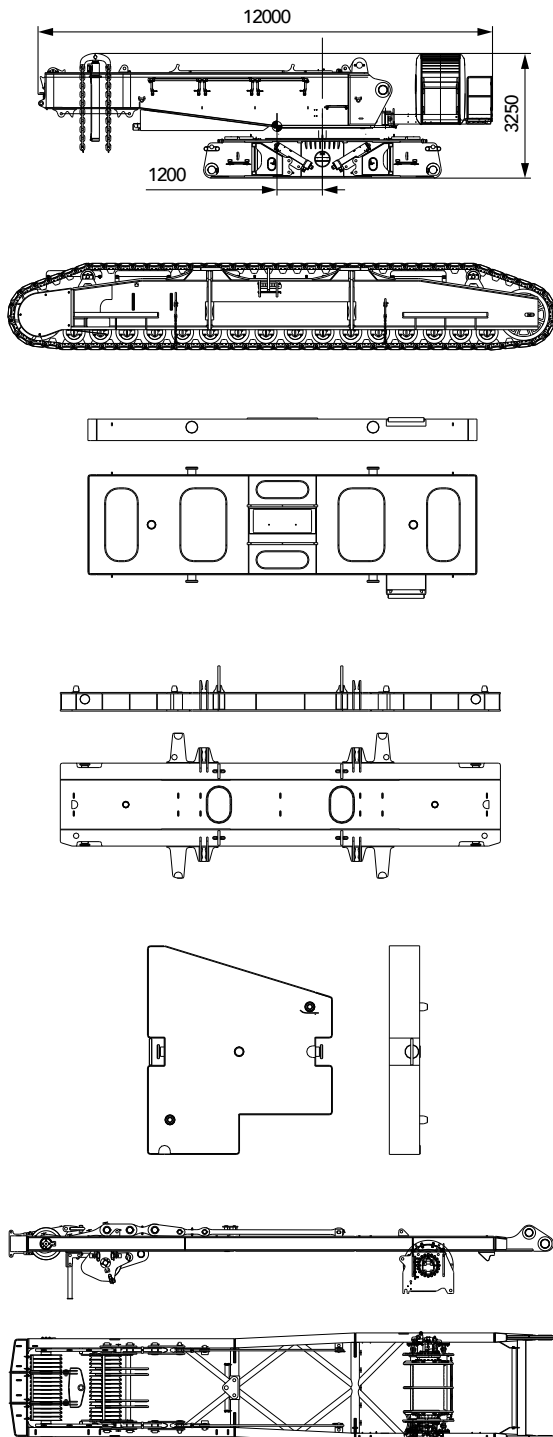

### Basic Machine

×1

Length(L)	12.00m
Width(W)	3.00m
Height(H)	3.25m
Weight	44.9t

### Crawler frames

×2

Length(L)	9.95m
Width(W)	1.70m
Height(H)	1.55m
Weight	27.5t

### Lower carbody counterweight

×2

Length(L)	5.80m
Width(W)	1.72m
Height(H)	0.33m
Weight	10.0t

### Rear counterweight tray

×1

Length(L)	8.06m
Width(W)	2.68m
Height(H)	0.84m
Weight	12.0t

### 8T counterweight block

×16

Length(L)	2.68m
Width(W)	2.38m
Height(H)	0.49m
Weight	8.0t

### Boom hoist mast

×1

Length(L)	10.91m
Width(W)	2.19m
Height(H)	1.38m
Weight	11.0t

## Transport Dimension

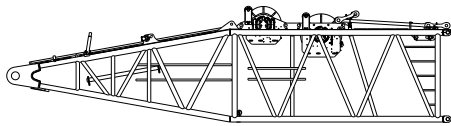

### Boom base

×1

Length(L)	12.33m
Width(W)	3.00m
Height(H)	3.2m
Weight	17.6t

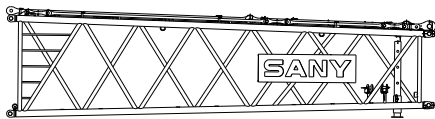

### Tapered insert

×1

Length(L)	10.68m
Width(W)	2.96m
Height(H)	2.79m
Weight	5.3t

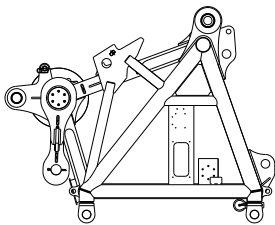

### Boom head

×1

Length(L)	2.90m
Width(W)	2.59m
Height(H)	2.32m
Weight	3.7t

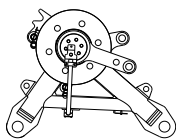

### Sheave block

×1

Length(L)	1.83m
Width(W)	1.44m
Height(H)	1.10m
Weight	1.7t

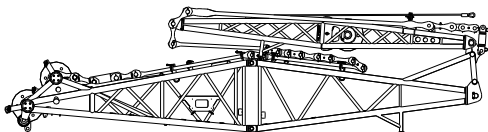

### Fixed jib base

×1

Length(L)	10.06m
Width(W)	2.50m
Height(H)	2.46m
Weight	5.1t

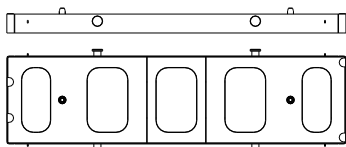

### Upper carbody counterweight

×2

Length(L)	5.80m
Width(W)	1.96m
Height(H)	0.37m
Weight	10.0t

## Transport Dimension

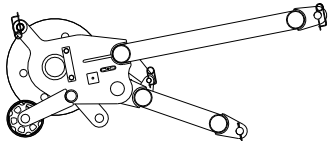

### Boom extension jib

×1

Length(L)	2.15m
Width(W)	1.08m
Height(H)	0.88m
Weight	0.4t

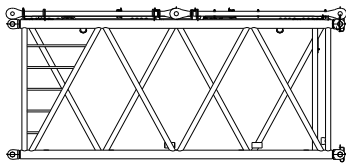

### 6m boom insert

×2

Length(L)	6.24m
Width(W)	2.96m
Height(H)	2.78m
Weight	2.4t

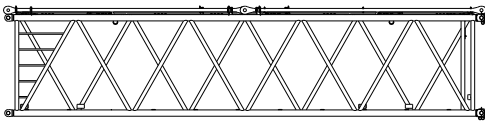

### 12m boom insert A

×2

Length(L)	12.24m
Width(W)	2.96m
Height(H)	2.78m
Weight	4.2t

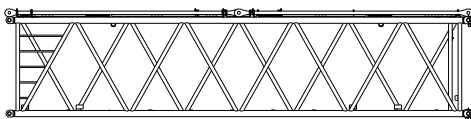

### 12m boom insert B

×2

Length(L)	12.24m
Width(W)	2.96m
Height(H)	2.78m
Weight	3.9t

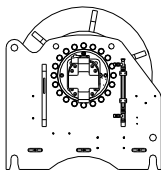

### Jib hoist winch

×1

Length(L)	1.75m
Width(W)	1.2m
Height(H)	1.2m
Weight	4.0t

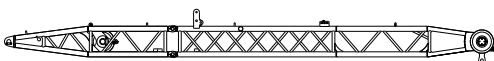

### Luffing jib front strut

×1

Length(L)	13.44m
Width(W)	2.18m
Height(H)	1.48m
Weight	3.4t



## Transport Dimension

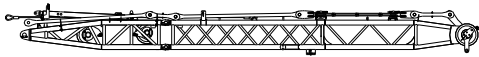

### Luffing jib rear strut ×1

Length(L)	12.94m
Width(W)	2.94m
Height(H)	1.29m
Weight	5.1t

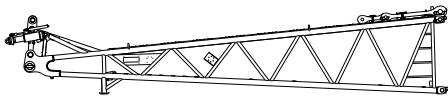

### Luffing jib base ×1

Length(L)	11.9m
Width(W)	2.56m
Height(H)	2.24m
Weight	3.9t

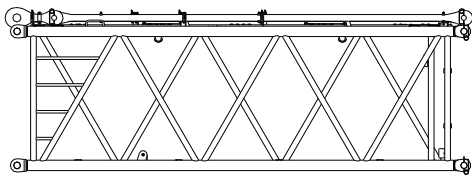

### 6m luffing jib I ×1

Length(L)	6.18m
Width(W)	2.56m
Height(H)	2.17m
Weight	1.9t

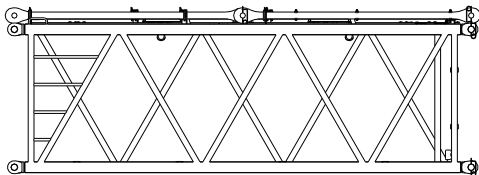

### 6m luffing jib II ×2

Length(L)	6.18m
Width(W)	2.56m
Height(H)	2.17m
Weight	1.8t

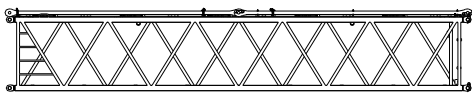

### 12m luffing jib ×4

Length(L)	12.18m
Width(W)	2.56m
Height(H)	2.17m
Weight	3.2t

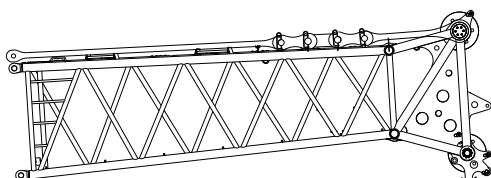

### Luffing jib top ×1

Length(L)	8.08m
Width(W)	2.56m
Height(H)	2.85m
Weight	4.9t

## Transport Dimension

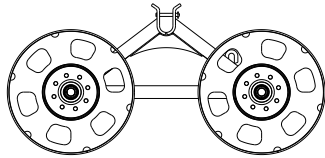

### Boom up trolley

×1

Length(L)	2.50m
Width(W)	2.35m
Height(H)	1.21m
Weight	1.62t

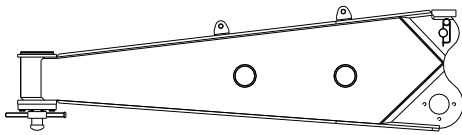

### Side erection outrigger assembly

×2

Length(L)	3.33m
Width(W)	0.79m
Height(H)	0.90m
Weight	1.1t

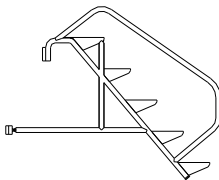

### Lowerworks ladder

×2

Length(L)	1.25m
Width(W)	0.56m
Height(H)	1.22m
Weight	0.05t

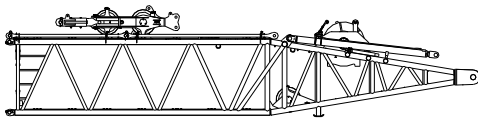

### Superlift mast base

×1

Length(L)	12.28m
Width(W)	3.00m
Height(H)	2.86m
Weight	14.66t

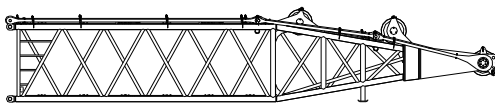

### Superlift mast top

×1

Length(L)	12.42m
Width(W)	2.9m
Height(H)	2.4m
Weight	8.56t

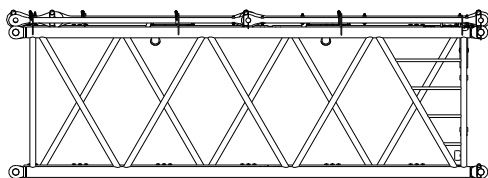

### Superlift mast insert

×1

Length(L)	6.18m
Width(W)	2.9m
Height(H)	2.2m
Weight	2.85t

## Transport Dimension

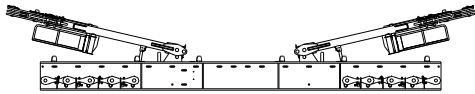

### Superlift counterweight tray ×1

Length(L)	9.95m
Width(W)	2.7m
Height(H)	1.8m
Weight	10.9t

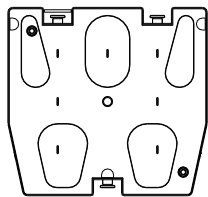

### 10t Counterweight ×19

Length(L)	2.49m
Width(W)	2.35m
Height(H)	0.54m
Weight	10t

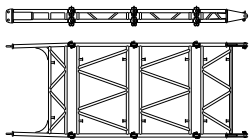

### Superlift strut ×1

Length(L)	7.8m
Width(W)	2.8m
Height(H)	0.45m
Weight	1.86t

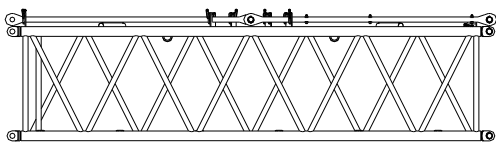

### 6m fixed jib insert ×1

Length(L)	6.2m
Width(W)	1.75m
Height(H)	1.6m
Weight	1t

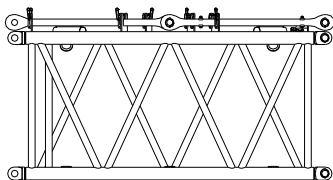

### 3m fixed jib insert ×1

Length(L)	3.2m
Width(W)	1.75m
Height(H)	1.6m
Weight	0.6t

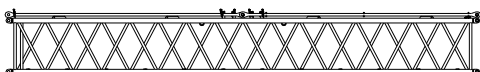

### 12m fixed jib insert ×2

Length(L)	12.2m
Width(W)	1.75m
Height(H)	1.6m
Weight	1.8t

## Transport Dimension

### Note:

- 1.The transport dimensions of each part in the table are schematic, not proportional to the real parts. The dimensions are designed value without package considered.
- 2.Weight is designed value that the actual manufactured part may deviate a little.
- 3.The dimensions and weight of each part may change due to product upgrading. The final values are subject to the new product.

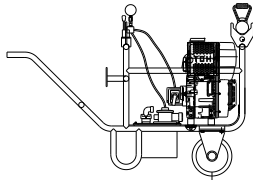

### Portable power plant

×1

Length(L)	1.56m
Width(W)	0.66m
Height(H)	1.08m
Weight	0.2t

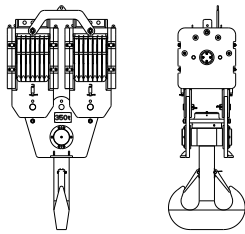

### 350t hook block (dual sheave)

×1

Length(L)	1.88m
Width(W)	1m
Height(H)	3.85m
Weight	8.09t

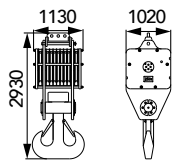

### 260t hook block

×1

Length(L)	1.02m
Width(W)	1.13m
Height(H)	2.93m
Weight	5.2t

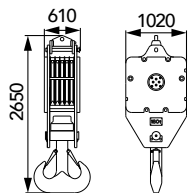

### 160t hook block

×1

Length(L)	0.61m
Width(W)	1.02m
Height(H)	2.65m
Weight	3t

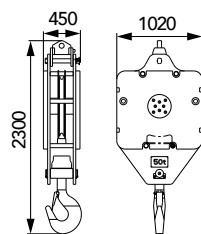

### 50t hook block

×1

Length(L)	0.45m
Width(W)	1m
Height(H)	2.3m
Weight	1.7t

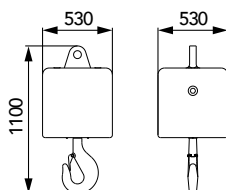

### 16t hook block

×1

Length(L)	0.53m
Width(W)	0.53m
Height(H)	1.10m
Weight	0.9t

## Transport Plan

Part	▪ Basic machine
Transport weight	▪ 44.9t
Truckload	▪ 1 truckload

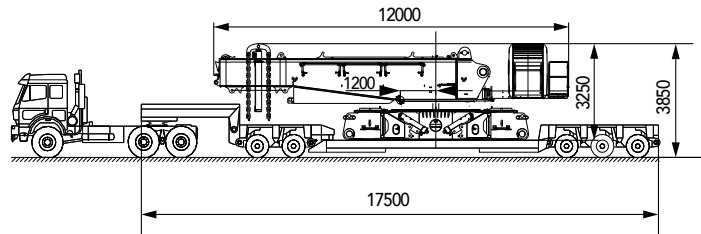

Part	▪ Crawler frames
Transport weight	▪ 27.5t
Truckload	▪ 2 truck loads

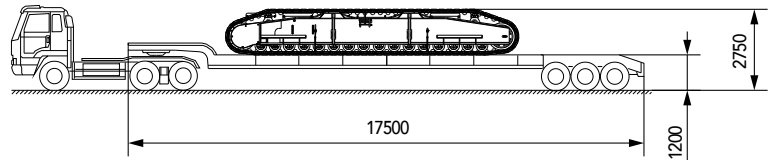

Part	▪ Boom hoist mast + 8t ▪ rear counterweight blocks x2
Transport weight	▪ 27t
Truckload	▪ 1 truckload

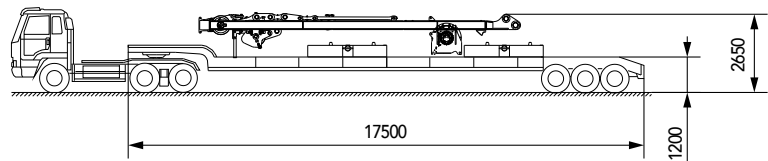

Part	▪ Boom base + 10t ▪ counterweight block x1
Transport weight	▪ 27.6t
Truckload	▪ 1 truckload

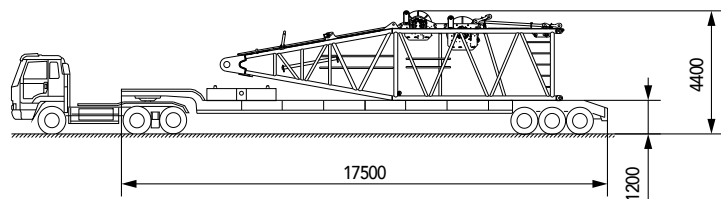

Part	▪ 6m boom + 6m luffing jib II ▪ 10t counterweight block x1 ▪ 8t counterweight block x2
Transport weight	▪ 30.2t
Truckload	▪ 1 truckload

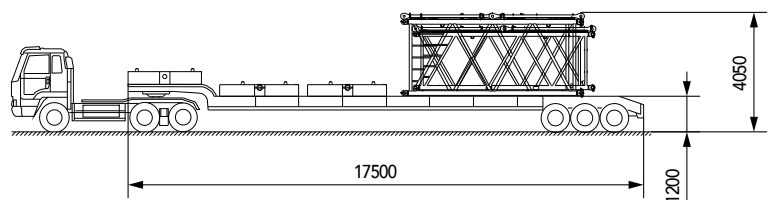

Part	▪ Luffing jib front mast ▪ luffing jib rear mast ▪ 10t counterweight block x2
Transport weight	▪ 28.5t
Truckload	▪ 1 truckload

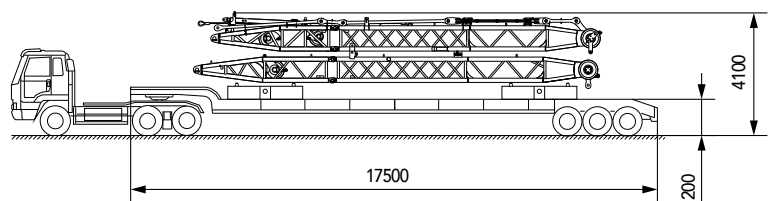

The above listed are some options for transport. The customer can find the optimal transport plan based on the detailed list below.

## Transport Specifications

SCC3500A Transport Specifications –Full up configuration

SN	Parts Name and Drawing No	QTY	Weight /t	Outline/m	
				L×W×H	
1	6m boom insert Q320A.512	2	2.40	6.24×2.96×2.78	
2	12m boom insert Q320A.515	2	4.20	12.24×2.96×2.78	
3	12m boom insert BQ320A.516	2	3.90	12.24×2.96×2.78	
4	Jib hoist mechanism q320a_313b	1	4.00	1.75×1.20×1.20	
5	Luffing jib front strut Q320A.561	1	3.40	13.44×2.18×1.48	
6	Luffing jib rear strut Q320A.562	1	5.10	12.94×2.94×1.29	
7	Luffing jib base Q320A.563	1	3.90	11.19×2.56×2.24	
8	6m luffing jib IQ320A.572	1	1.90	6.18×2.56×2.17	
9	6m luffing jib IIQ320A.573	2	1.80	6.18×2.56×2.17	
10	12m luffing jib Q320A.575	4	3.20	12.18×2.56×2.17	
11	Luffing jib top Q320A.564	1	4.90	8.08×2.56×2.85	
12	Boom up trolley Q320A.566	1	1.62	2.50×2.35×1.21	
13	Side outrigger assembly Q320A.207	2	1.10	3.33×0.79×0.90	
14	Basic machine	1	44.90	12.00×3.00×3.25	
15	Crawler frame	2	27.50	9.95×1.70×1.55	
16	Lower carbody counterweight block	2	10.00	5.80×1.72×0.33	
17	Upper carbody counterweight block	2	10.00	5.80×1.96×0.37	
18	Rear counterweight tray	1	12.00	8.06×2.68×0.84	
19	8Tcounterweight block	16	8.00	2.68×2.38×0.49	
20	Boom hoist mast	1	11.00	10.91×2.19×1.38	
21	Boom base	1	17.60	12.33×3.00×3.2	
22	Tapered insert	1	5.30	10.68×2.96×2.79	
23	Boom head	1	3.70	2.90×2.59×2.32	
24	Sheave block	1	1.70	1.83×1.44×1.10	
25	Fixed jib base	1	5.10	10.06×2.50×2.46	
26	Boom extension jib	1	0.40	2.15×1.08×0.88	
27	Lowerworks ladder	2	0.05	1.25×0.56×1.22	
28	Superlift mast base (12m) Q320A.591	1	14.66	12.28×3.00×2.86	
29	Superlift mast top (12m) Q320A.592	1	8.56	12.42×2.90×2.40	
30	Superlift mast insert (6m) Q320A.593	1	2.85	6.18×2.90×2.20	
31	Superlift counterweight tray	1	10.90	9.95×2.70×1.80	
32	10t Counterweight block	19	10.00	2.49×2.35×0.54	
33	6m fixed jib insert Q320A.545	1	1.00	6.20×1.75×1.60	
34	12m fixed jib insert Q320A.547	2	1.80	12.20×1.75×1.60	
35	3m fixed jib insert Q320A_544	1	0.60	3.20×1.75×1.60	
36	Portable power plant	1	0.20	1.56×0.66×1.08	
37	350t hook block (double sheave)	1	8.09	1.88×1.00×3.85	
38	260t hook block	1	5.20	1.02×1.13×2.93	
39	160t hook block	1	3.00	0.61×1.02×2.65	
40	100t hook block	1	2.30	0.51×1.00×2.48	
41	50t hook block	1	1.70	0.45×1.00×2.30	
42	16t ball hook	1	0.90	0.53×0.53×1.10	
43	Superlift strut	1	1.86	7.80×2.80×0.45	
44	Additional pendant strap	1	1.10		
45	Suspension cable	1	0.78		
46	Other attachment	1	0.30		

## Self-assembly plan

### 1) Basic machine self-assembly

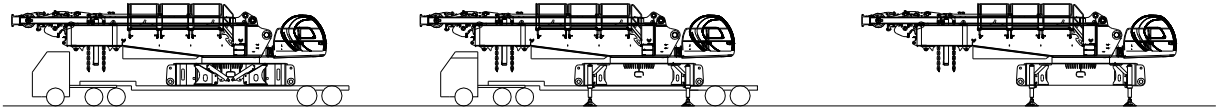

### 2) Crawler frames self-assembly

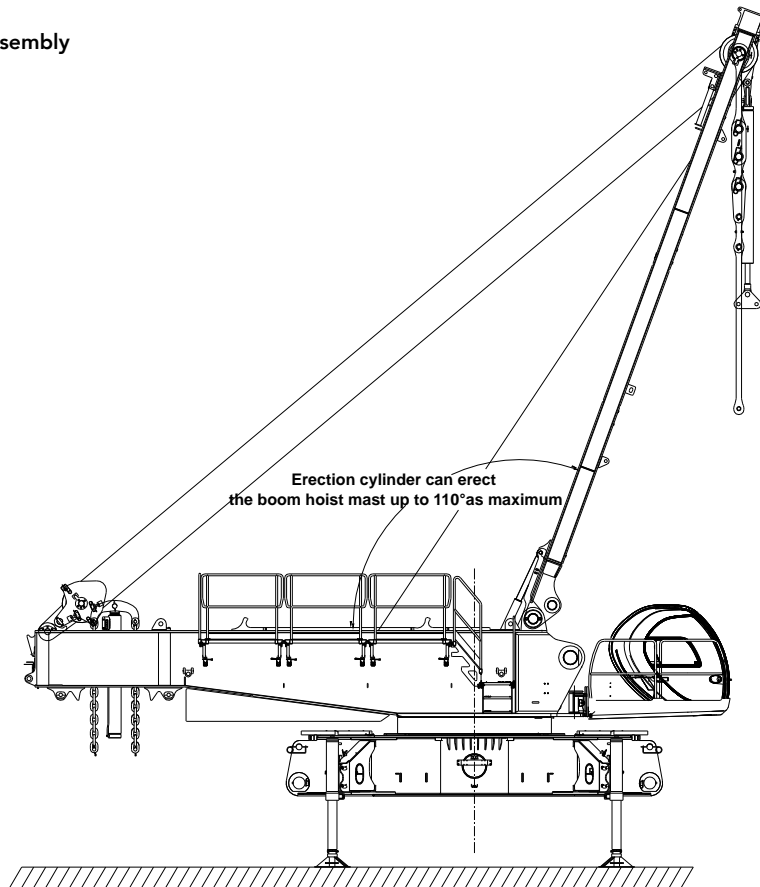

**Self-assembly plan**

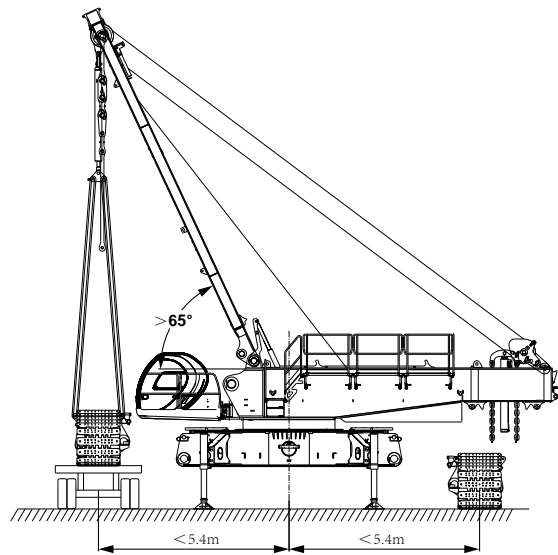
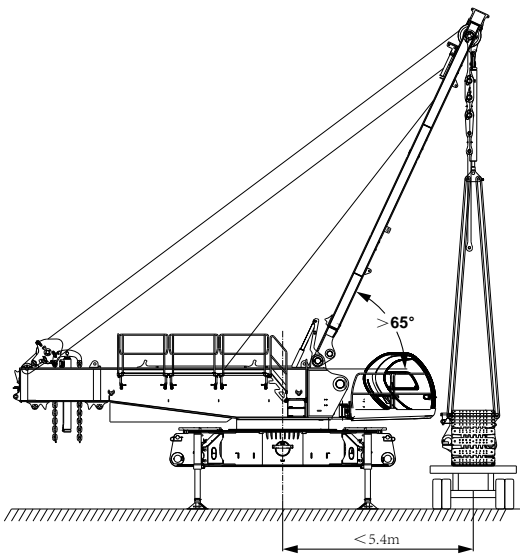
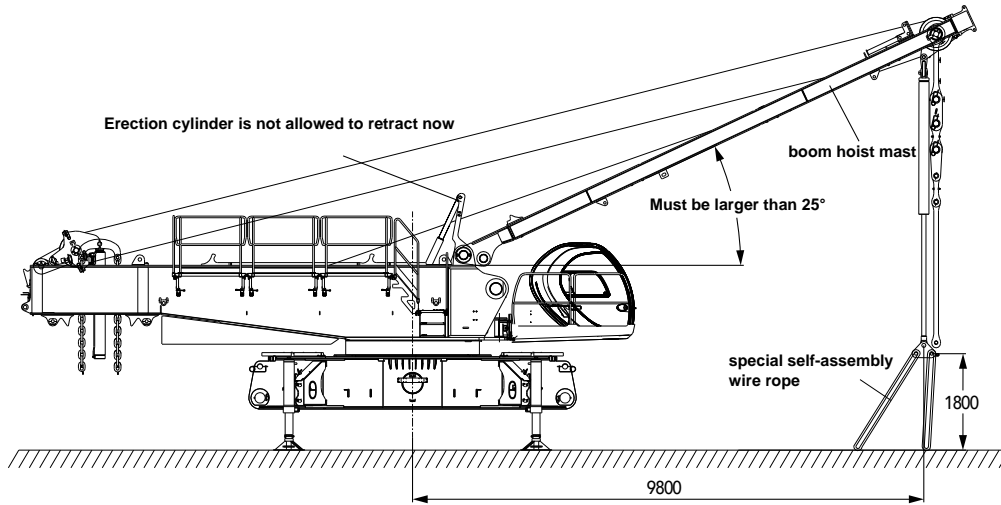



## Self-assembly plan

### 3) Counterweight and boom base self-assembly

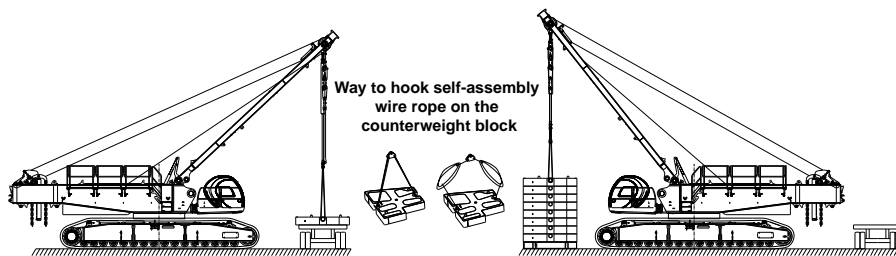
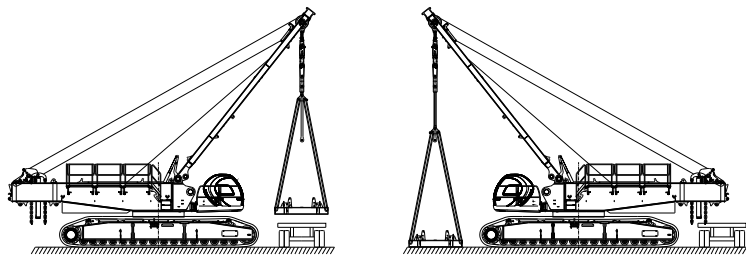
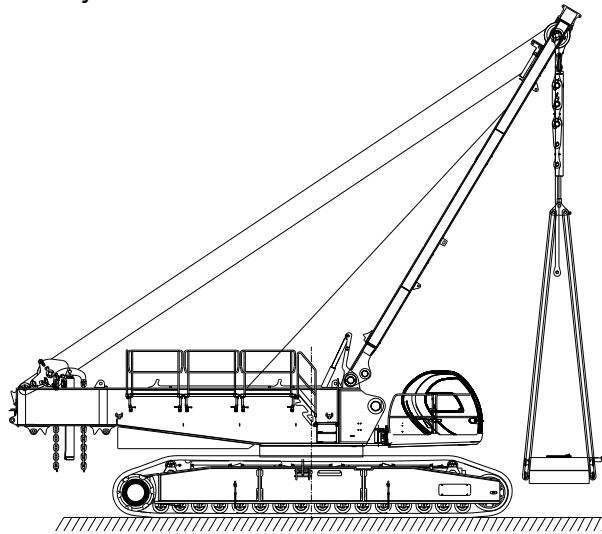

## Self-assembly plan

Way to hook self-assembly  
wire rope on the boom base

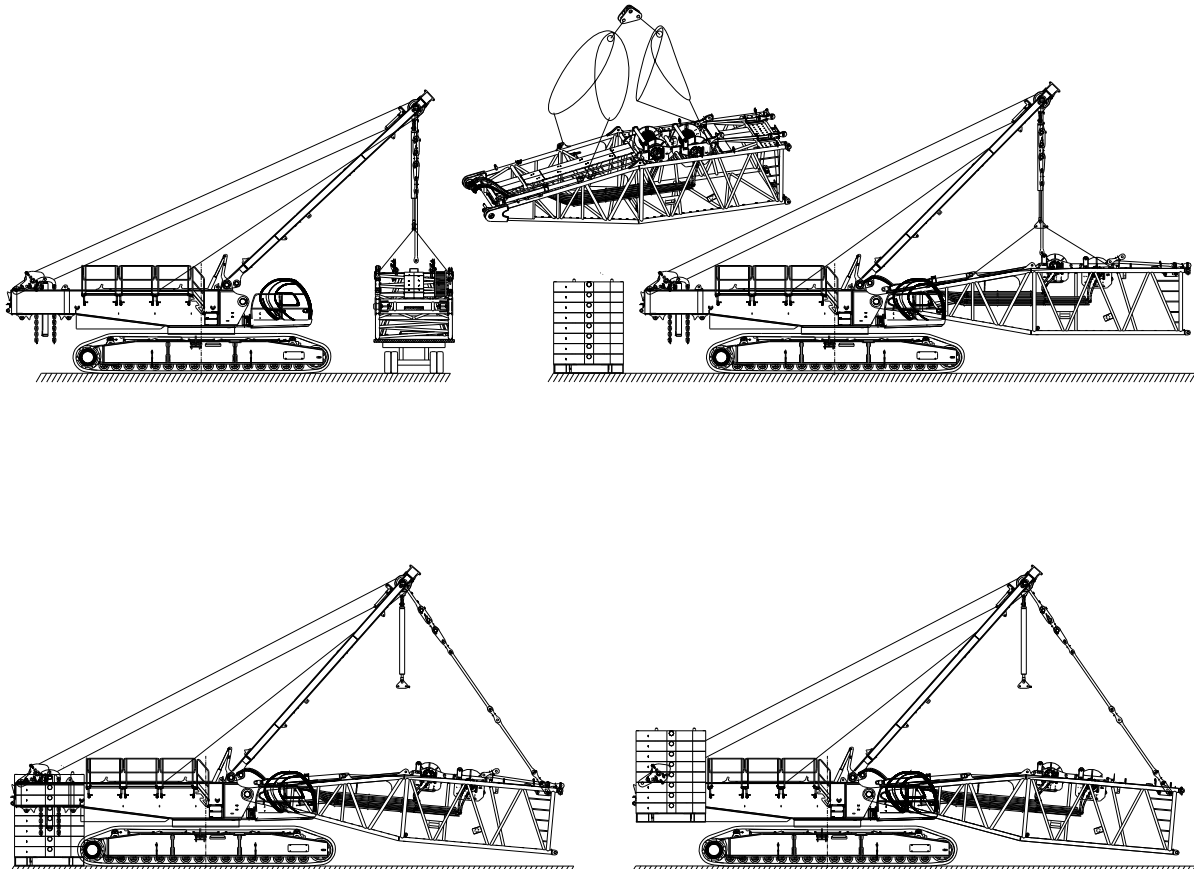

## Self-assembly plan

### 4) Boom assembly schematics

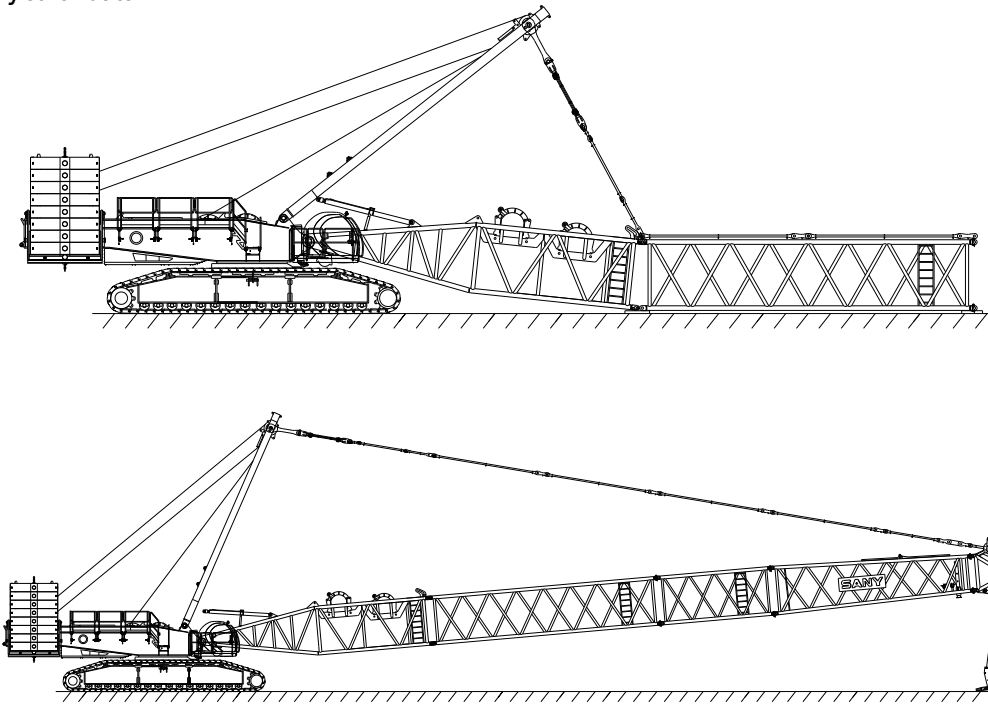

### 5) Superlift assembly schematics

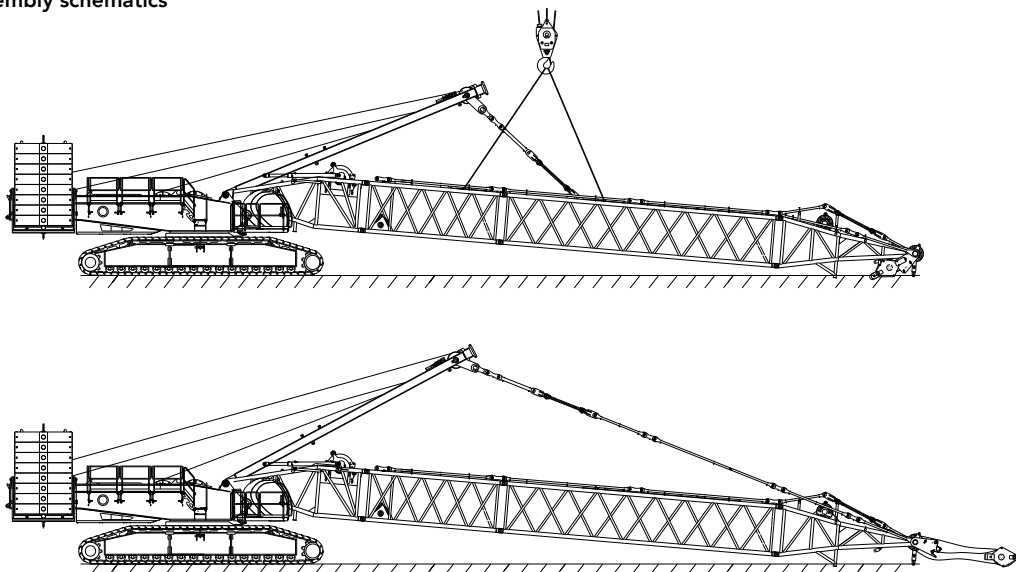

## Self-assembly plan

### 6) Luffing jib assembly schematics

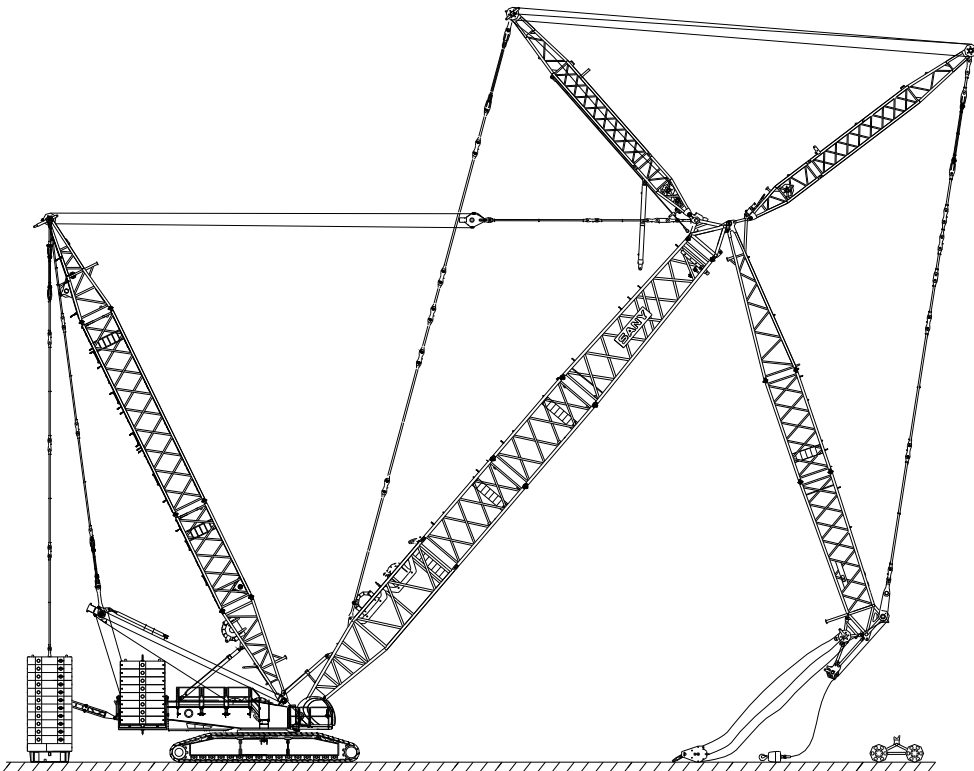
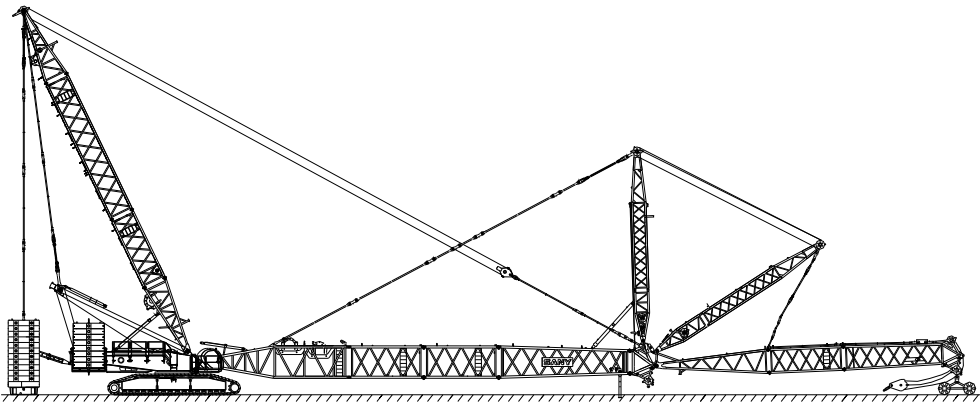

## Self-assembly plan

### 7) Fixed jib assembly schematics

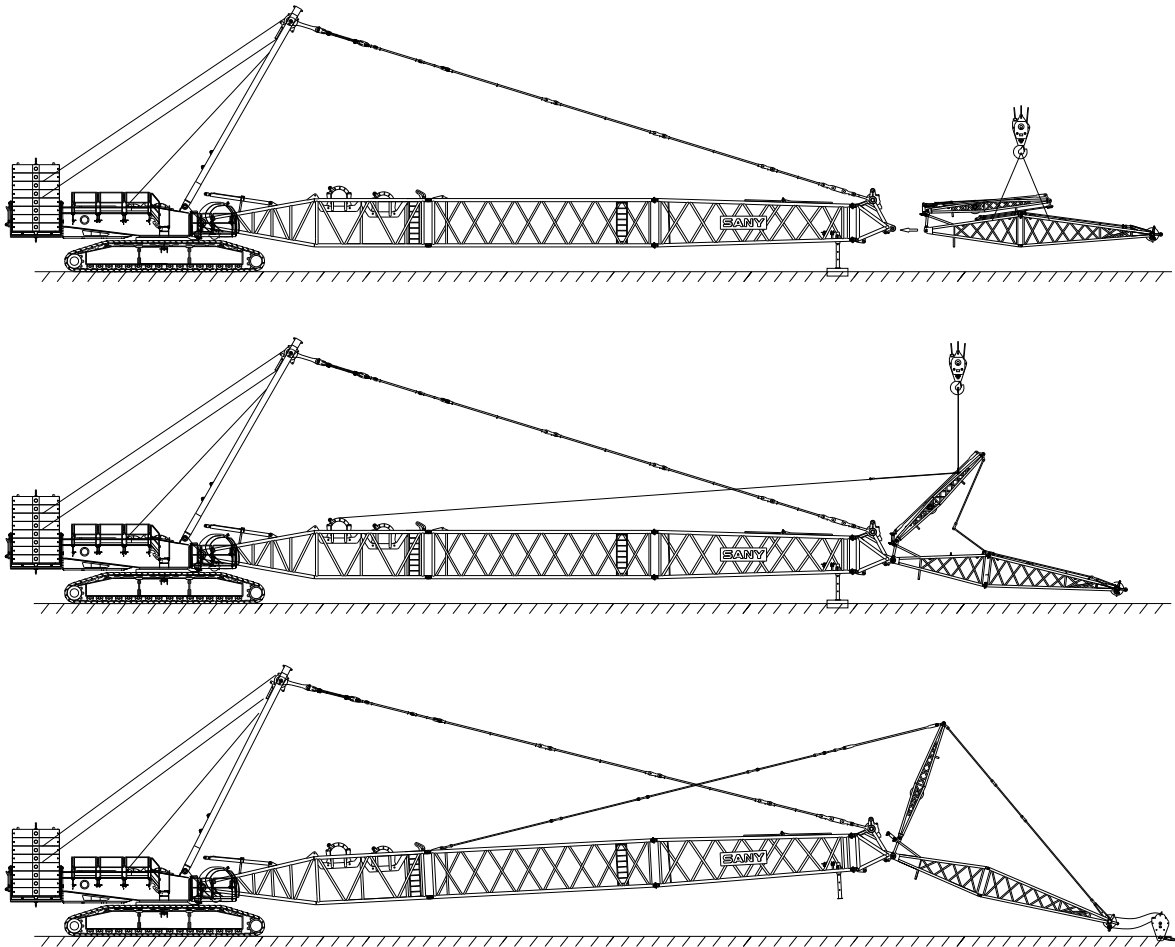



# **SCC3500A** **SANY CRAWLER CRANE** **350 TONS LIFTING CAPACITY**

QUALITY CHANGES THE WORLD

## Cofigurations

- Page 31 Configurations
- Page 33 H Configuration
- Page 36 HDB Configuration
- Page 39 HJ Configuration
- Page 42 HJDB configuration
- Page 45 FJ configuration
- Page 50 LJ Configuration
- Page 55 LJDB Configuration
- Page 61 Shield Configuration

> 30

## Configurations

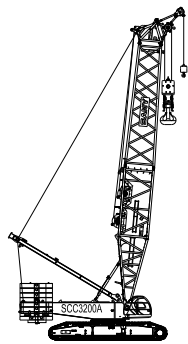

H,24m~84m

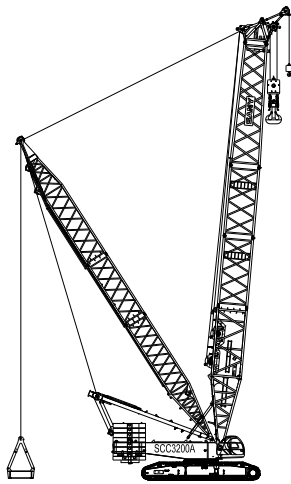

HD/HDB,36m~84m

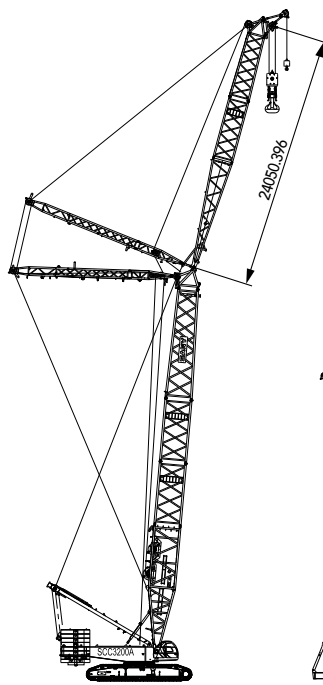

LJ,60m+72m

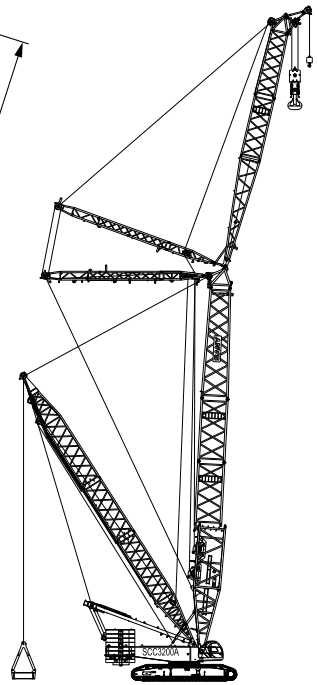

LJD/LJDB,84m+84m

## Configurations

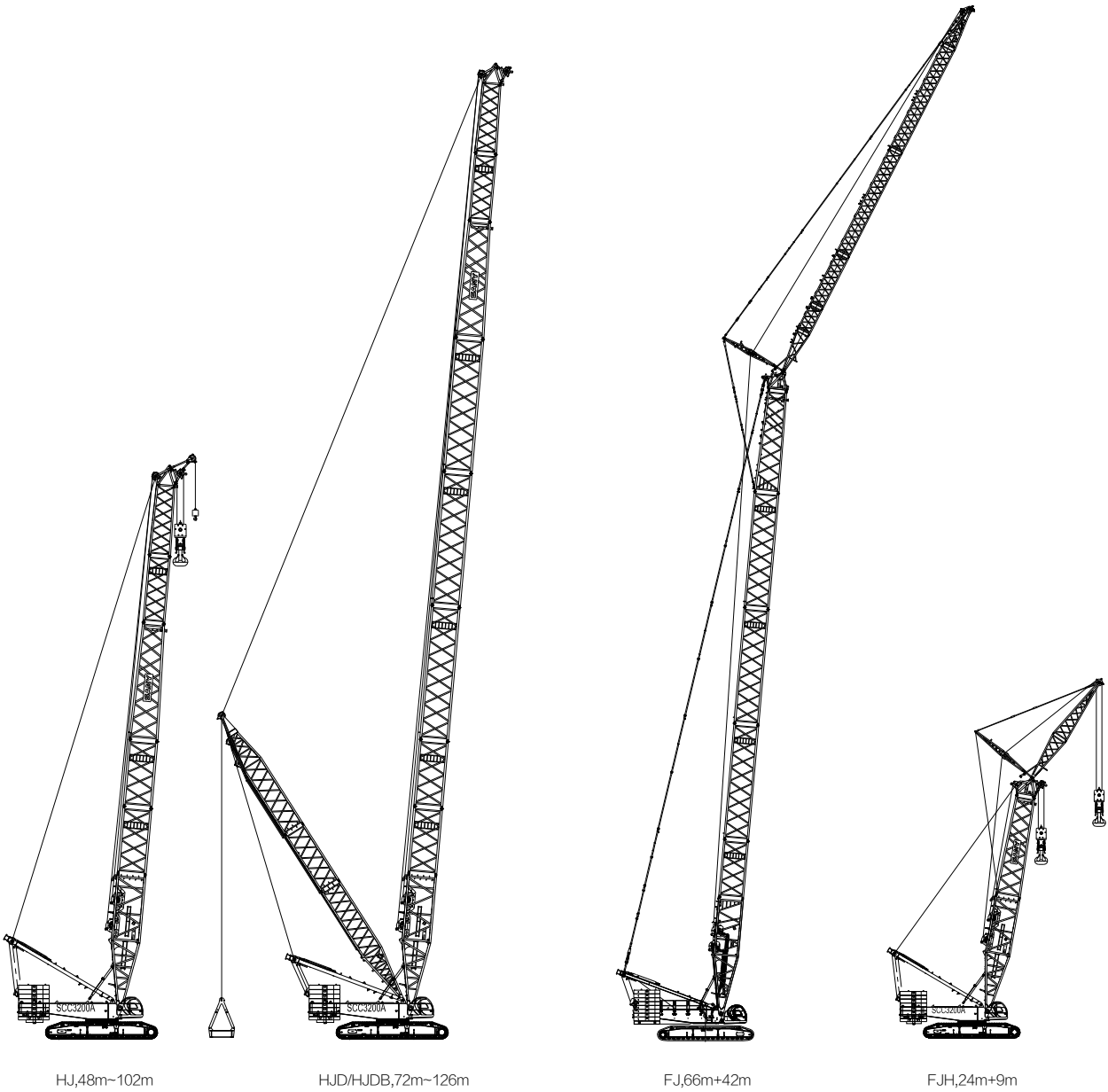



## Boom Combination in H

Boom Combination in H			
Boom length (m)	Boom Insert		
	6m	12mA	12mB
24	-	-	-
30	1	-	-
36	2	-	-
42	1	1	-
48	2	1	-
54	1	2	-
60	2	2	-
66	1	2	1
72	2	2	1
78	1	2	2
84	2	2	2

Note:  
24m basic boom consists of 12m boom section, 10.5m transition insert and 1.5m boom head.

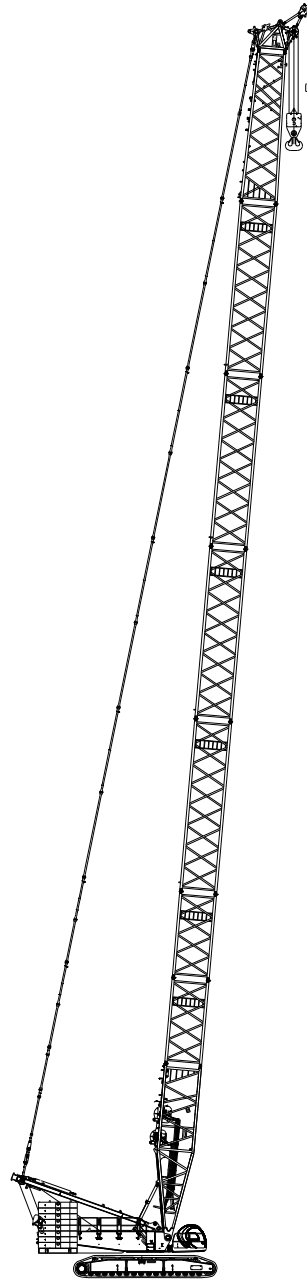

H 84m

## Working Radius in H Configuration

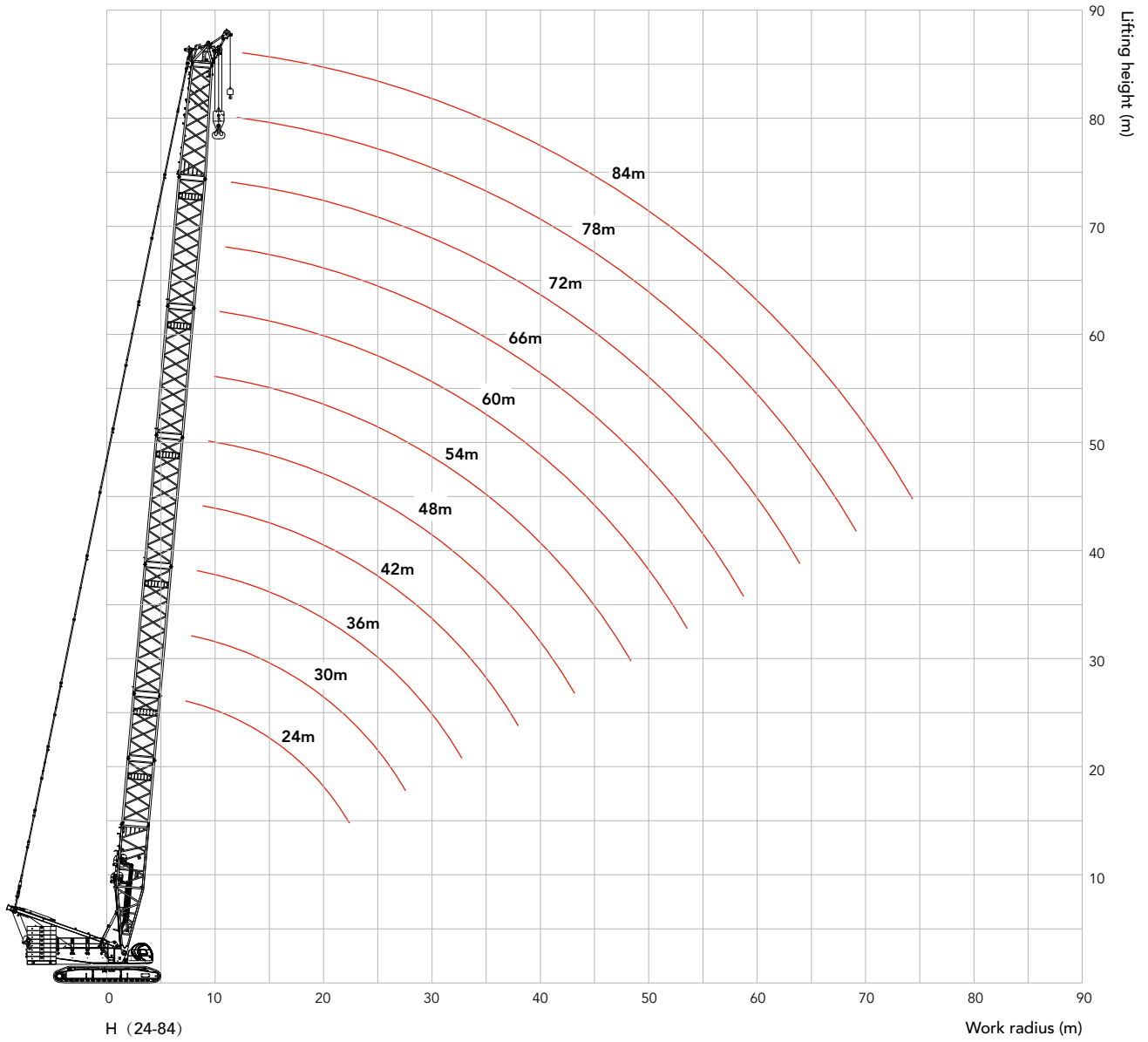

Unit: t

## Load Chart--H

SCC3500 Crawler Crane — H												
Boom length 24-84m, Rear counterweight 140t, Carbody counterweight 40t												
Radius (m)	24	30	36	42	48	54	60	66	72	78	84	Radius (m)
6	350	350										6
7	335.5	335.1	322.4	300.3								7
8	294.9	292.5	273.9	257.5	242.5	229.1						8
9	259.5	251.9	237.6	224.9	213	202.3	192.3	183.3				9
10	230.1	220.7	209.4	199.2	189.6	180.8	172.5	165	157.7	151		10
11	202.2	196.1	186.9	178.5	170.5	163.1	156	149.7	143.4	137.7	129.4	11
12	176.1	176.1	168.4	161.4	154.6	148.3	142.2	136.7	131.2	126.3	121.3	12
14	139.2	139.8	140	134.9	129.8	125	120.2	116	111.7	107.7	103.7	14
16	114.3	114.8	115	115.1	111.2	107.4	103.5	100.1	96.5	93.3	89.9	16
18	96.3	96.9	97	97.1	96.8	93.7	90.4	87.6	84.5	81.8	78.9	18
20	82.7	83.3	83.4	83.5	83.2	82.6	79.8	77.4	74.7	72.4	69.8	20
22	72	72.7	72.8	72.8	72.5	72.3	71.1	69	66.6	64.6	62.3	22
24		64.1	64.2	64.3	64	63.8	63.3	62	59.8	57.9	55.8	24
26		57	57.2	57.3	57	56.7	56.3	55.9	53.9	52.3	50.3	26
28		51.1	51.3	51.4	51.1	50.8	50.4	50.1	48.9	47.3	45.5	28
30			46.3	46.4	46.1	45.9	45.4	45.1	44.4	43	41.3	30
32			41.9	42.1	41.8	41.6	41.1	40.8	40.3	39.2	37.6	32
34				38.4	38.1	37.8	37.3	37.1	36.5	35.9	34.3	34
36				35.1	34.8	34.6	34.1	33.8	33.2	32.8	31.3	36
38				32.1	31.9	31.7	31.2	30.9	30.3	30	28.6	38
40					29.3	29.1	28.6	28.3	27.8	27.4	26.2	40
44						24.7	24.2	23.9	23.3	23	22	44
48						21	20.5	20.3	19.7	19.4	18.5	48
52							17.5	17.3	16.7	16.3	15.4	52
56								14.7	14.1	13.8	12.8	56
60									11.9	11.6	10.5	60
64									9.9	9.6	8.5	64
68										7.9	6.7	68
72											5.1	72

## Boom combination in HDB

Boom combination in HDB			
Boom length (m)	Insert		
	6m	12mA	12mB
36	2	-	-
42	1	1	-
48	2	1	-
54	1	2	-
60	2	2	-
66	1	2	1
72	2	2	1
78	1	2	2
84	2	2	2

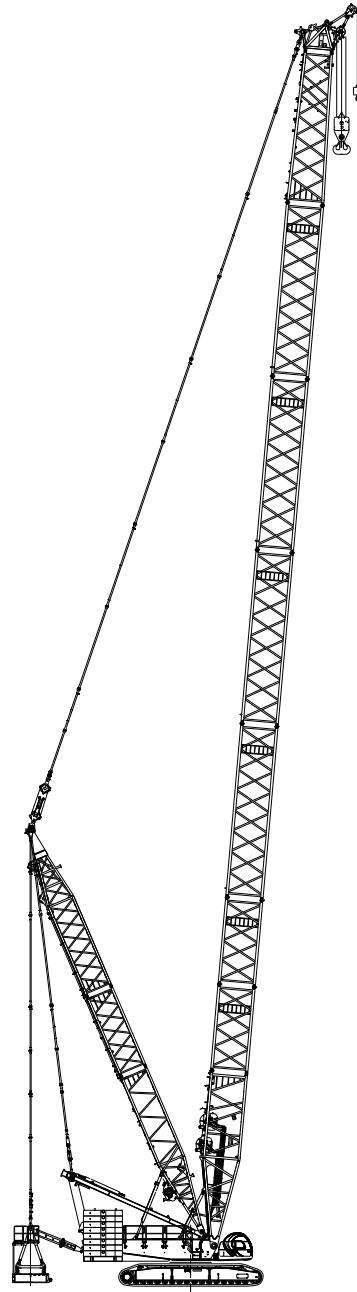

HDB 84m

## Work Radius of HDB

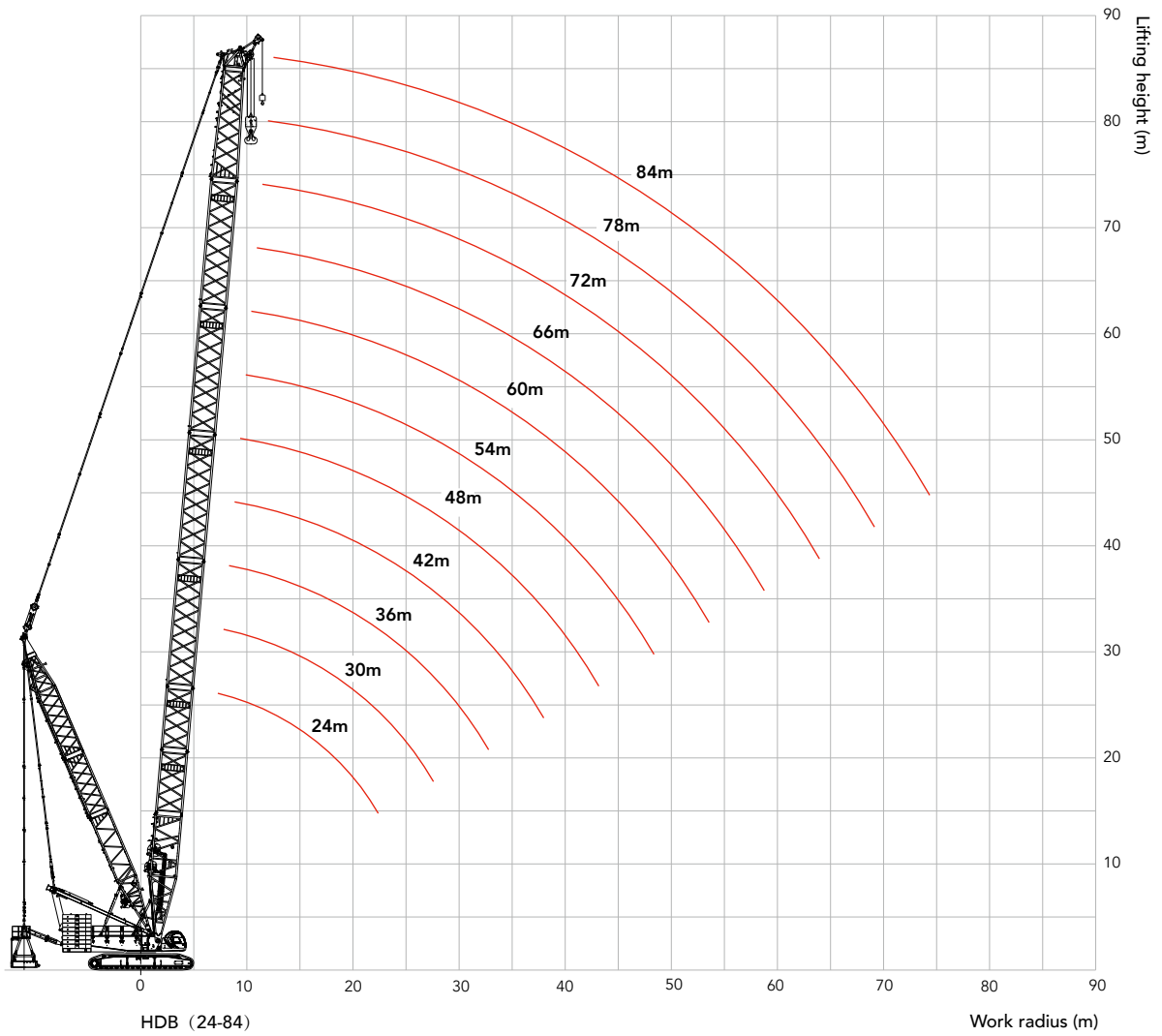

## Load Chart of HDB

SCC3500A Crawler Crane — HDB										
Boom length 36-84m, Superlift radius 11m, Superlift counterweight 0t, Rear counterweight 140t, Carbody counterweight 40t										
Radius (m)	36	42	48	54	60	66	72	78	84	Radius (m)
7	350									7
8	307.5	288.3								8
9	266.9	252	239.6	228						9
10	235.4	223.4	213.4	204.1	195.1	186.9				10
11	210.2	200.4	192.1	184.3	176.8	169.9	163			11
12	189.6	181.3	174.4	167.8	161.3	155.4	149.5	144	138.6	12
14	157.9	151.8	146.6	141.7	136.8	132.3	127.6	123.4	119	14
16	131	129.9	125.9	122.1	118.1	114.6	110.8	107.3	103.7	16
18	110.7	110.6	109.8	106.7	103.5	100.5	97.3	94.5	91.4	18
20	95.3	95.2	95.4	94.4	91.6	89.2	86.4	84	81.3	20
22	83.3	83.2	83.3	83.5	81.9	79.8	77.3	75.2	72.8	22
24	73.7	73.6	73.7	73.7	73.6	71.9	69.7	67.8	65.6	24
26	65.7	65.7	65.7	65.8	65.6	65.1	63.1	61.4	59.5	26
28	59.1	59	59	59.1	58.9	58.8	57.5	55.9	54.1	28
30	53.4	53.4	53.4	53.4	53.2	53.1	52.5	51.1	49.4	30
32	48.5	48.5	48.5	48.6	48.3	48.3	47.9	46.8	45.2	32
34		44.3	44.3	44.3	44.1	44	43.6	43	41.5	34
36		40.6	40.6	40.6	40.4	40.3	39.9	39.6	38.2	36
38		37.3	37.3	37.3	37.1	37	36.6	36.3	35.2	38
40			34.3	34.4	34.1	34	33.6	33.4	32.5	40
44				29.3	29.1	29	28.6	28.4	27.7	44
48				25.2	24.9	24.9	24.5	24.2	23.7	48
52					21.4	21.4	21	20.8	20.3	52
56						18.4	18	17.8	17.3	56
60							15.5	15.3	14.7	60
64							13.2	13	12.4	64
68								11.1	10.4	68
72									8.5	72

## Boom Combination in HJ

Boom Combination in HJ				
Boom length (m)	Boom insert		Jib insert	
	6m	12mA	6m	12m
48	2	-	-	-
54	1	1	-	-
60	1	1	1	-
66	2	1	1	-
72★	2	1	-	1
78★	2	1	1	1
84★	1	2	1	1
90★	1	2	-	2
96★	2	2	-	2
102★	2	2	1	2

**Note:**

The 12m boom base, 12m transition section, 6m luffing jib, 7.5m jib top are mandatory, and boom length with ★ must use mid-suspension cable, otherwise, the boom may break.

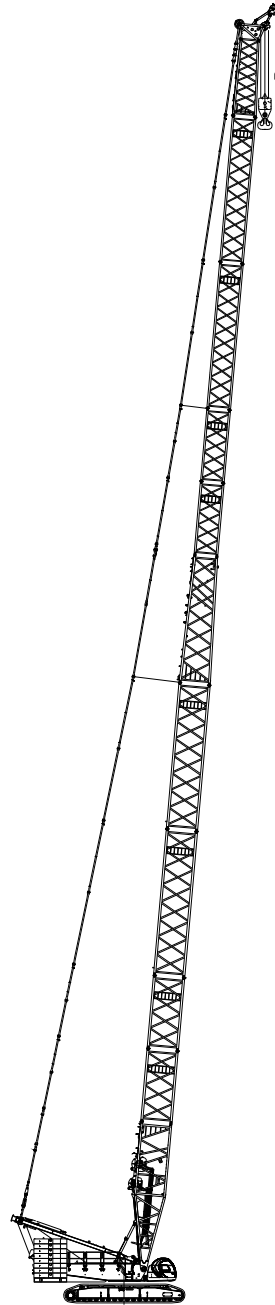

HJ 102m

# Working Radius of HJ

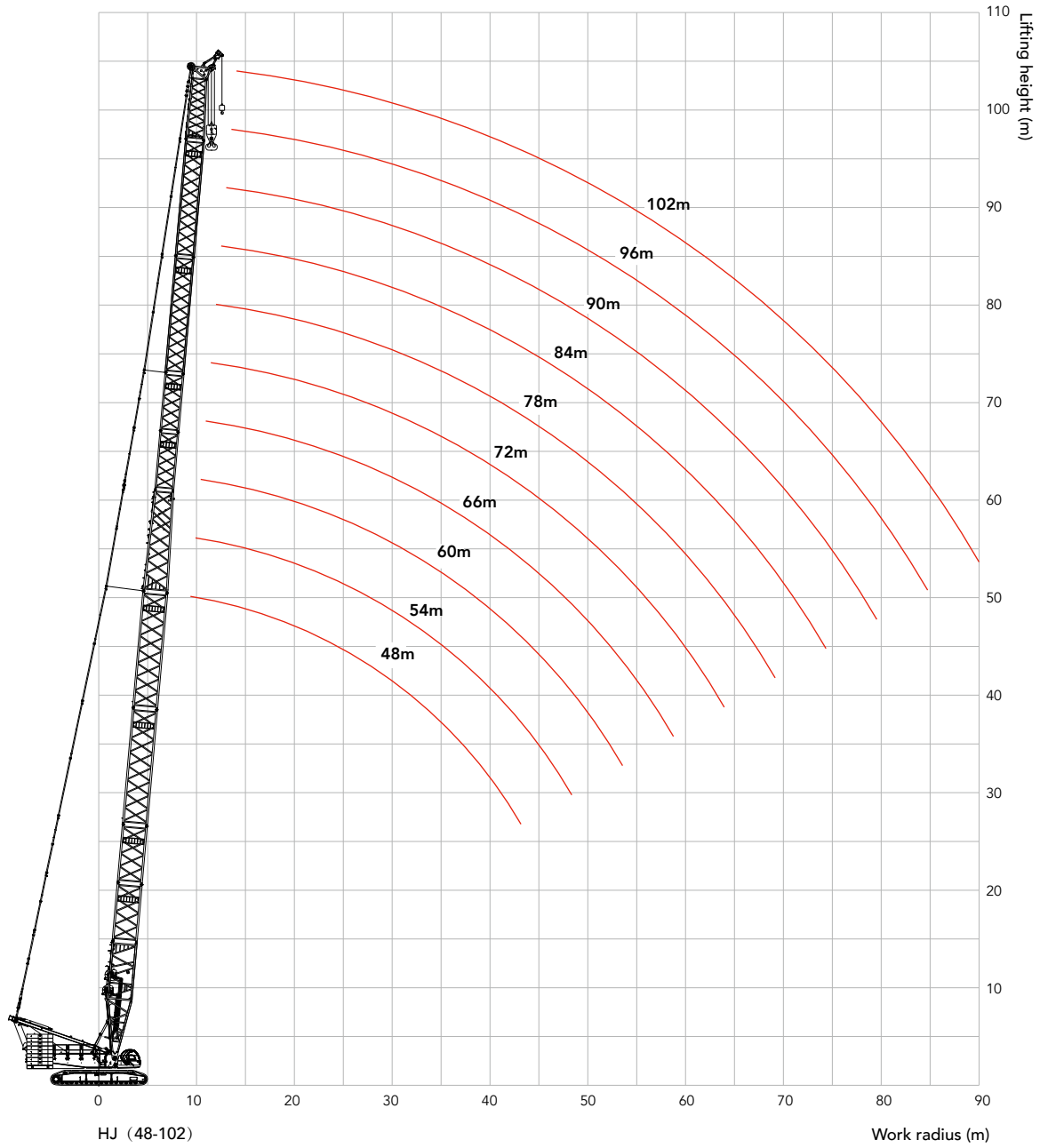



Unit: t

## Load Chart of HJ

SCC3500A Crawler Crane — HJ											
Boom length 48-102m, Rear counterweight 140t, Carbody counterweight 40t											
Radius (m)	48	54	60	66	72	78	84	90	96	102	Radius (m)
8	220										8
9	215.9	205.1	195.5								9
10	192.5	183.7	175.8	168							10
11	173.5	166.1	159.4	152.7	146.9	134.6					11
12	157.6	151.3	145.7	139.8	134.8	129.9	125				12
14	132.9	128.1	123.8	119.2	115.3	111.5	107.5	104.1	98.3	82.5	14
16	114.4	110.6	107.2	103.4	100.3	97.1	93.8	91.1	87.9	80.4	16
18	99.2	96.9	94.1	90.9	88.3	85.7	82.9	80.5	77.7	75.3	18
20	85.6	85.4	83.6	80.8	78.6	76.3	73.8	71.8	69.3	67.2	20
22	75	74.8	74.7	72.4	70.5	68.5	66.3	64.6	62.3	60.3	22
24	66.5	66.3	66.1	65.4	63.7	61.9	59.9	58.4	56.3	54.5	24
26	59.5	59.2	59.1	58.6	57.9	56.3	54.4	53	51.1	49.4	26
28	53.6	53.4	53.3	52.7	52.5	51.4	49.6	48.4	46.5	45	28
30	48.7	48.4	48.3	47.7	47.5	47.1	45.5	44.3	42.6	41.1	30
32	44.4	44.1	44	43.4	43.2	43	41.8	40.7	39	37.7	32
34	40.7	40.4	40.3	39.7	39.5	39.2	38.5	37.5	35.9	34.6	34
36	37.4	37.2	37	36.5	36.2	35.9	35.4	34.6	33.1	31.8	36
38	34.5	34.3	34.1	33.6	33.4	33.1	32.5	32	30.5	29.3	38
40	31.9	31.7	31.6	31	30.8	30.5	30	29.6	28.2	27	40
44		27.3	27.2	26.6	26.4	26.1	25.6	25.3	24.1	23	44
48		23.7	23.6	23	22.8	22.5	22	21.7	20.7	19.7	48
52			20.6	20	19.8	19.5	18.9	18.7	17.8	16.8	52
56				17.4	17.1	16.9	16.4	16.1	15.3	14.3	56
60					13.9	14.7	14.2	13.9	13	12.1	60
64					11.3	12.8	12.3	12	11.1	10.2	64
68						11.1	10.6	10.3	9.4	8.4	68
72							9.1	8.9	7.8	6.9	72
76								7.5	6.4	5.5	76
80								6.3	5.1		80
84									4		84

## Boom combination of HJDB

Boom combination of HJDB					
Boom length (m)	Boom insert			Jib insert	
	6m	12mA	12mB	6m	12m
72	2	2	-	-	-
78	1	2	1	-	-
84	2	2	1	-	-
90★	1	2	2	-	-
96★	2	2	2	-	-
102★	2	2	2	1	-
108★	2	2	2	-	1
114★	2	2	2	1	1
120★	2	2	2	2	1
126★	2	2	2	1	2

**Note:**

The 12m boom base, 12m transition section, 6m luffing jib, 7.5m jib top are mandatory, and boom length with ★ must use mid-suspension cable, otherwise, the boom may break.

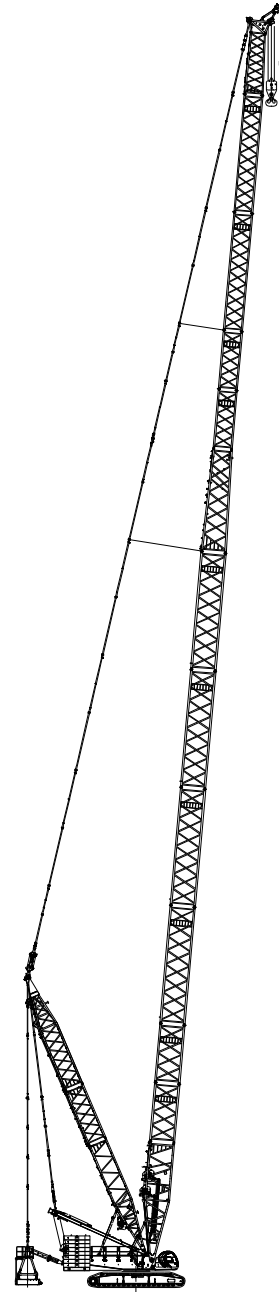

HJDB 126m

## Working Radius of HJDB

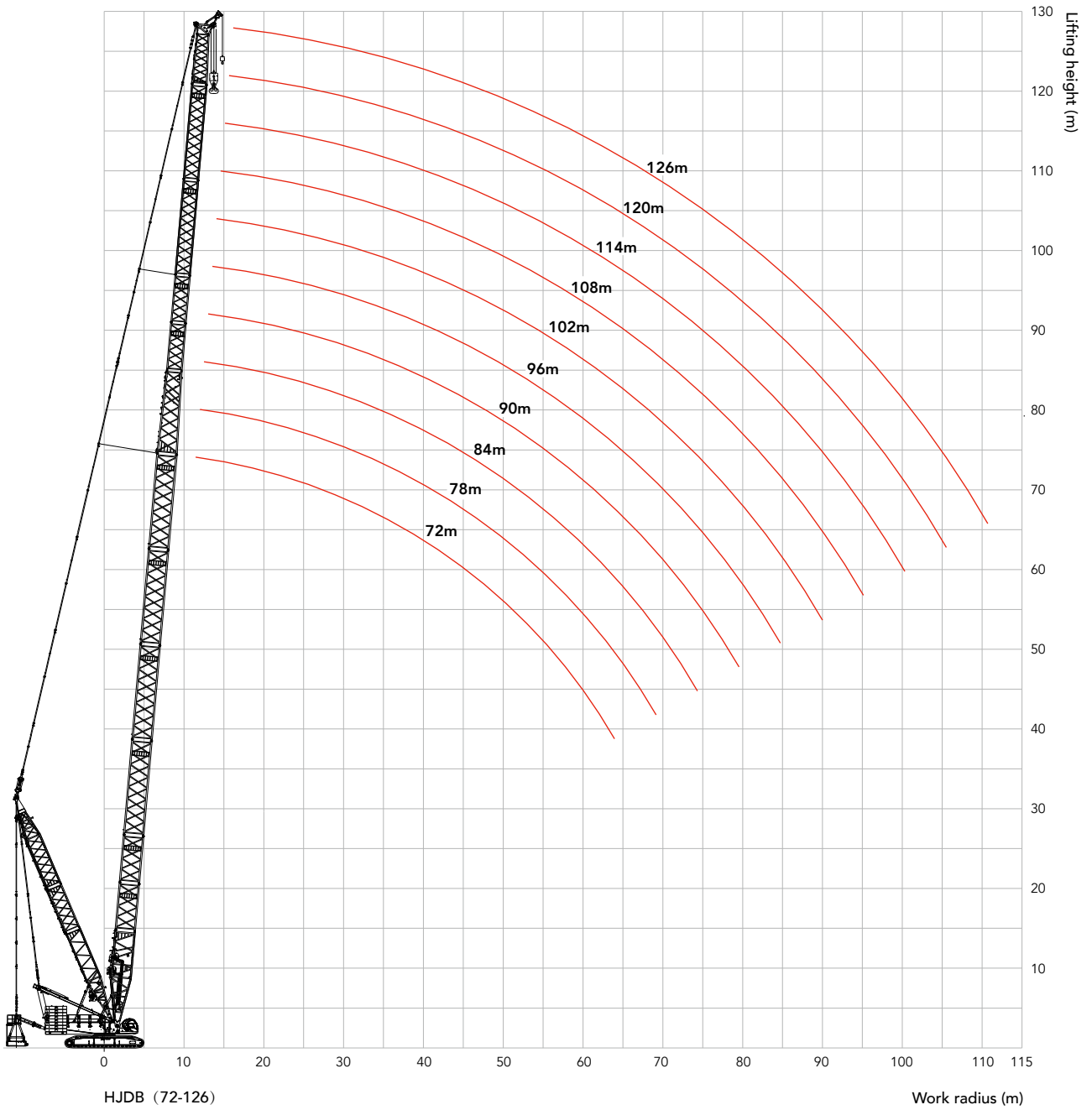

## Load Chart of HJDB

SCC3500A Crawler Crane — HJDB											
Boom length 72-126m, Superlift radius 15m, Superlift counterweight 200t, Rear counterweight 140t, Carbody counterweight 40t											
Radius (m)	72	78	84	90	96	102	108	114	120	126	Radius (m)
11	220*	185.0*									11
12	220*	186.0*	160.8*								12
14	220*	185.4*	160.2*	134.6*	118.2*	101.8*	88.5*				14
16	220	185.7*	160.4*	134.6*	118.3*	102.0*	88.7*	77.5*	67.9*	59.4*	16
18	220	185.7*	160.5*	134.1*	118.2*	101.6*	88.8*	77.6*	67.9*	59.4*	18
20	220	185.6	160.3*	133.9*	118.0*	101.6*	88.9*	77.6*	67.5*	59.3*	20
22	211.9	185.3	160	133.7*	117.7*	101.6*	88.9*	77.6*	67.5*	59.0*	22
24	193.4	184.8	159.1	133.4	117.4*	102.1*	88.9*	77.5*	67.4*	58.6*	24
26	177.6	177.3	158.7	133.7	117.0*	102.0*	88.8*	77.4*	67.2*	58.1*	26
28	164.1	163.7	159.1	133.2	116.5	101.9*	88.7*	77.2*	66.7*	57.7*	28
30	152.3	151.9	151.2	132.7	116.6	100.5	88.6*	76.6*	66.2*	57.3*	30
32	142	141.6	140.8	129.1	116.1	96.9	88.4*	76.0*	65.7*	56.8*	32
34	132.8	132.5	131.7	124.1	112.9	93.9	88.2	75.4*	65.2*	56.4*	34
36	124.7	124.3	123.6	119.1	108.5	90.4	87.5	74.8*	64.7*	55.9*	36
38	117.4	117	116.2	114.9	103.8	86.9	86.8	74.2	64.2*	55.5*	38
40	110.8	110.4	109.7	108.9	100.1	84	86.2	73.6	63.6*	55.0*	40
44	99.4	99	98.2	97.5	91.8	78.8	84.7	72.3	62.6	54.1*	44
48	89.8	89.4	88.7	88	84.8	74.1	83.3	71.2	61.5	53.1	48
52	81.4	81.1	80.4	79.7	78	70.2	78.3	69.9	60.4	52.2	52
56	74.3	73.9	73.3	72.6	71.5	67.3	71.2	68.6	59.3	50.5	56
60	68.1	67.8	67.1	66.4	65.1	64.3	65	64.5	58.2	48.5	60
64	62.6	62.3	61.6	61	59.9	59.9	59.6	59.1	57.3	46.5	64
68		57.5	56.9	56.2	54.4	55.1	54.9	54.3	53.8	44.9	68
72			52.6	51.9	49.1	50.8	50.6	50.1	49.6	43.3	72
76				48.1	44.3	47	46.8	46.3	45.8	42	76
80				44.5	39.5	43.6	43.4	42.9	42.4	40.7	80
84					34.6	40.5	40.3	39.8	39.3	39	84
88						37.7	37.5	36.9	36.5	36.2	88
92							34.9	34.4	33.9	33.6	92
96								32	31.5	31.2	96
100									29.8	29.4	100
104										27.3	104
108											108

## Boom combination of 12m light FJ

Boom combination of 12m light FJ				
Jib length (m)	Insert			Boomlength 24m-66m
	3m	6m	12m	
9	-	-	-	
12	1	-	-	
18	1	1	-	
24	1	-	1	
30	1	1	1	
36	1	-	2	
42	1	1	2	

Note:  
the 24m-66m boom sections are connected in the same way as boom connection in H configuration.

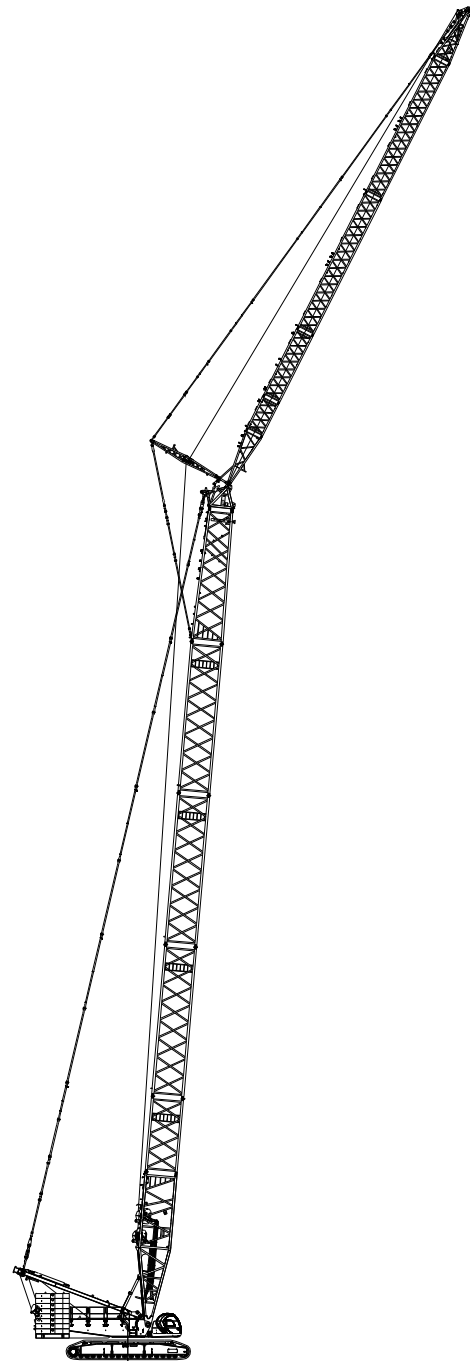

FJ 66m+42m

# Work Radius of FJ

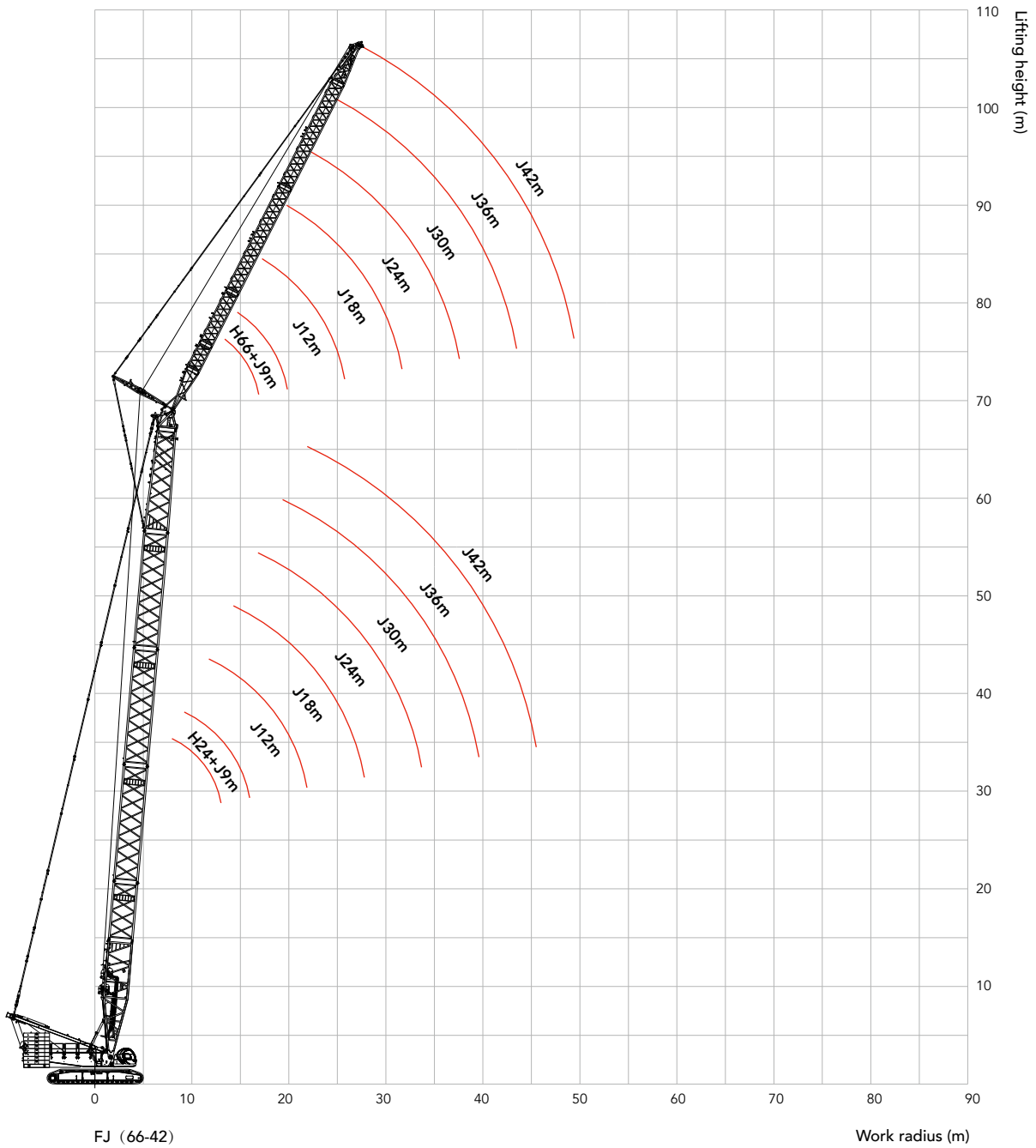

Unit: t

## Load Chart of FJ

SCC3500A Crawler Crane — FJ									
Boom length 24-66m, Jib length 9m, Boom to jib angle 20°, Rear counterweight 140t, Carbody counterweight 40t									
Radius (m)	24	30	36	42	48	54	60	66	Radius (m)
9	162	162							9
10	153	158	160	156					10
11	146	151	154	153	146	140			11
12	140	146	145	139	133	128	123	112	12
14	129	126	121	117	112	108	104	100	14
16	117	106	104	100	96.9	93.6	90.2	87.2	16
18	99.6	89.4	89.2	87.5	84.5	81.7	78.9	76.4	18
20	85.7	76.9	76.6	76.5	74.5	72.1	69.6	67.5	20
22	74.8	67.1	66.8	66.6	66.2	64.2	62.0	60.1	22
24	66.0	59.3	58.9	58.7	58.3	57.6	55.6	53.9	24
26	58.8	52.8	52.4	52.2	51.8	51.4	50.1	48.6	26
28	52.8	47.3	47.0	46.8	46.3	46.0	45.3	43.9	28
30	47.5	42.7	42.4	42.2	41.7	41.4	40.9	39.8	30
32		38.7	38.4	38.2	37.8	37.4	36.9	36.3	32
34		35.2	35.0	34.8	34.3	34.0	33.4	33.2	34
36		32.1	31.9	31.7	31.3	30.9	30.4	30.1	36
38			29.2	29.0	28.6	28.2	27.8	27.4	38
40			26.8	26.6	26.1	25.9	25.3	25.1	40
44				22.5	22.1	21.7	21.2	20.9	44
48					18.7	18.3	17.8	17.4	48
52					15.6	15.3	14.7	14.4	52
56						12.7	12.1	11.8	56
60							9.9	9.6	60
64								7.6	64
68								5.9	68

## Load Chart of FJ

SCC3500A Crawler Crane — FJ									
Boom length 24-66m, Jib length 30m, Boom to jib angle 20°, Rear counterweight 140t, Carbody counterweight 40t									
Radius (m)	24	30	36	42	48	54	60	66	Radius (m)
18	59.8	59.9							18
20	57.4	58.0	58.0	57.9	57.6	56.8			20
22	54.5	56.1	56.7	56.7	56.3	55.8	54.0	45.6	22
24	51.3	53.0	54.0	55.1	55.3	54.1	52.5	44.4	24
26	48.1	50.3	51.5	52.8	53.8	52.5	51.2	43.2	26
28	45.9	47.7	49.3	50.4	49.9	48.5	47.0	41.8	28
30	43.8	45.5	46.4	46.0	45.7	44.4	43.0	40.8	30
32	41.6	42.7	42.3	42.0	41.5	40.8	39.5	38.3	32
34	39.6	39.1	38.7	38.4	37.9	37.6	36.3	35.1	34
36	36.5	36.0	35.6	35.2	34.8	34.4	33.4	32.4	36
38	33.7	33.3	32.8	32.4	32.0	31.6	30.9	29.8	38
40	31.3	30.8	30.4	30.0	29.5	29.1	28.6	27.6	40
44	27.0	26.6	26.1	25.7	25.2	24.8	24.3	23.6	44
48	23.5	23.1	22.6	22.3	21.7	21.3	20.8	20.2	48
52	20.5	20.2	19.7	19.3	18.8	18.4	17.9	17.3	52
56		17.6	17.1	16.8	16.3	15.9	15.3	14.8	56
60			15.0	14.6	14.0	13.5	12.9	12.5	60
64				12.6	12.0	11.5	10.8	10.4	64
68				10.7	10.1	9.7	9.0	8.6	68
72					8.5	8.1	7.4	7.0	72
76						6.5	6.0	5.5	76
80							4.6	4.3	80
84								3.0	84



Unit: t

## Load Chart of FJ

SCC3500A Crawler Crane — FJ									
Boom length 24-66m, Jib length 42m, Boom to jib angle 20°, Rear counterweight 140t, Carbody counterweight 40t									
Radius (m)	24	30	36	42	48	54	60	66	Radius (m)
24	35.5	35.5	35.6	35.4					24
26	34.3	34.4	34.5	34.7	34.6	34.5	34.2	32.7	26
28	33.0	33.3	33.7	33.9	33.9	33.6	33.7	32.1	28
30	31.6	32.3	32.8	32.9	33.0	33.0	33.0	31.0	30
32	29.8	30.8	31.6	32.2	32.3	32.4	32.4	30.4	32
34	28.5	29.5	30.5	31.0	31.5	31.7	31.7	29.7	34
36	27.1	28.1	29.1	29.7	30.6	31.0	31.1	28.9	36
38	25.8	26.9	27.9	28.7	29.4	30.0	30.5	28.2	38
40	24.8	26.0	26.8	27.6	28.4	29.0	29.1	27.6	40
44	22.8	23.9	24.9	25.6	26.4	26.1	25.2	24.3	44
48	21.1	22.1	23.2	23.3	22.8	22.5	21.7	20.9	48
52	19.7	20.7	20.7	20.3	19.8	19.4	18.9	18.0	52
56	18.5	18.8	18.2	17.8	17.3	16.9	16.3	15.5	56
60	17.0	16.5	16.1	15.6	15.2	14.6	14.1	13.3	60
64	15.0	14.6	14.2	13.7	13.1	12.6	12.0	11.4	64
68		12.8	12.4	11.9	11.3	10.8	10.1	9.6	68
72			10.7	10.2	9.7	9.1	8.5	8.1	72
76				8.8	8.1	7.7	7.1	6.6	76
80				7.3	6.8	6.3	5.7	5.3	80
84					5.5	5.2	4.5	4.1	84
88						4.0	3.4	3.0	88

## Boom combination of LJ

Boom combination of LJ		
Boom length (m)	Jib insert	
	6m	12m
24	-	-
30	1	-
36	2	-
42	1	1
48	2	1
54	1	2
60	2	2
66	1	3
72 ★	2	3

**Note:**

The main boom configuration is the same as that in H configuration. Jib configuration includes: jib base, 6m tapered insert, jib top are mandatory.

Jib configuration includes: jib base, 6m tapered insert, jib top are mandatory.

Boom length with ★ must use mid-suspension cable, otherwise, the boom may break.

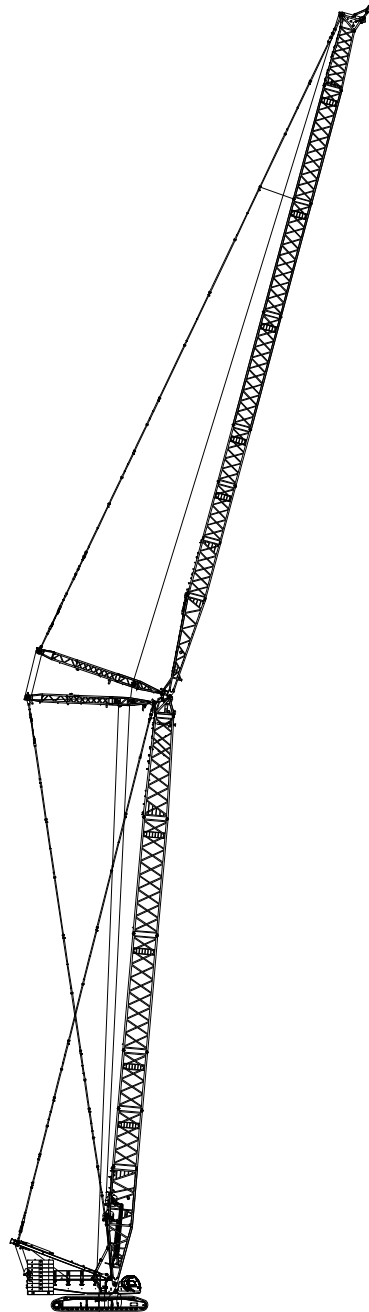

LJ 60m+72m

## Work radius of LJ

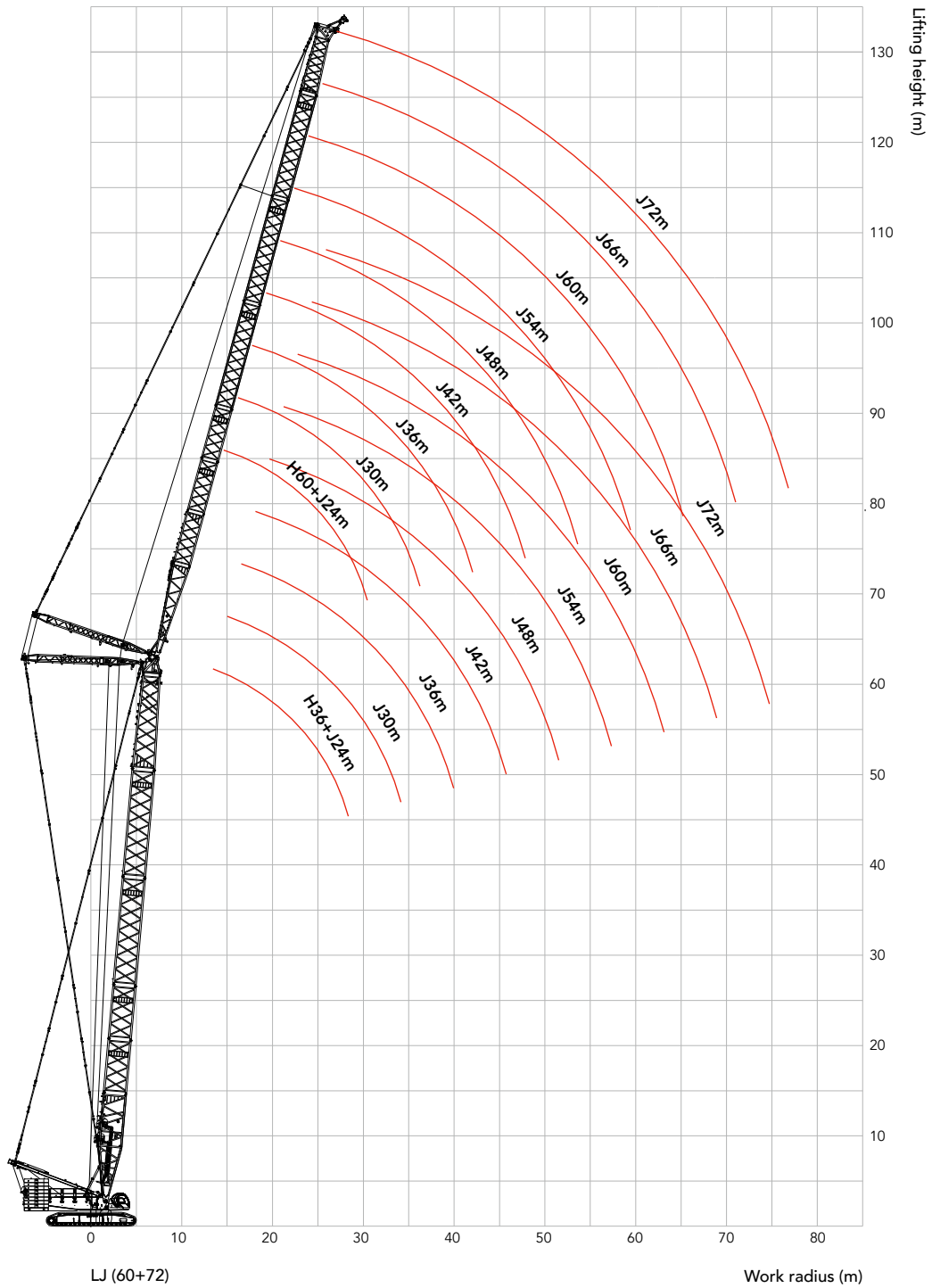

## Load Chart of LJ

SCC3500A Crawler Crane — LJ										
Boom length 36m, Boom angle 85°, Jib length 24-72m, Rear counterweight 140t, Carbody counterweight 40t										
Radius (m)	24	30	36	42	48	54	60	66	72	Radius (m)
14	130.1	125.4								14
16	113.9	110	106.2							16
18	101.2	97.8	94.6	91.6						18
20	90.9	88	85.1	82.5	79.9					20
22	82.4	79.8	77.3	74.9	72.6	70.4	68.2			22
24	74	73	70.7	68.5	66.4	64.4	62.4	60.5		24
26	66.7	66.6	65	63	61.1	59.3	57.4	55.6	53.5	26
28		60.5	60.1	58.3	56.4	54.8	53	51.4	49.4	28
30		55.3	55	54.1	52.4	50.8	49.2	47.7	45.8	30
32		50.8	50.6	50.2	48.8	47.3	45.8	44.3	42.5	32
34			46.7	46.4	45.6	44.2	42.7	41.4	39.6	34
36			43.3	43	42.5	41.4	40	38.7	37	36
38			40.3	40	39.6	38.9	37.5	36.3	34.6	38
40				37.3	36.9	36.5	35.3	34.1	32.5	40
44					32.4	32	31.4	30.2	28.7	44
48					28.6	28.3	27.8	27	25.5	48
52						25.2	24.7	24.2	22.8	52
56							22.1	21.7	20.4	56
60								19.4	18.3	60
64								17.4	16.5	64
68									14.8	68

Unit: t

## Load Chart of LJ

SCC3500A Crawler Crane — LJ										
Boom length 54m, Boom angle 85°, Jib length 24-72m, Rear counterweight 140t, Carbody counterweight 40t										
Radius (m)	24	30	36	42	48	54	60	66	72	Radius (m)
14	114.1									14
16	100.8	97.3								16
18	90.1	87.1	84.2							18
20	81.4	78.7	76.1	73.7						20
22	74.1	71.7	69.4	67.2	64.9	62.9				22
24	68	65.8	63.6	61.6	59.6	57.7	55.8			24
26	62.7	60.7	58.7	56.8	54.9	53.2	51.4	49.2		26
28	58.1	56.2	54.4	52.6	50.9	49.3	47.5	46	42.4	28
30		52.4	50.6	49	47.3	45.8	44.2	42.7	40.8	30
32		48.9	47.3	45.7	44.1	42.7	41.1	39.7	37.9	32
34		45.9	44.3	42.8	41.3	39.9	38.4	37.1	35.3	34
36			41.6	40.2	38.7	37.4	36	34.7	33	36
38			39.2	37.8	36.4	35.2	33.8	32.5	30.9	38
40				35.7	34.3	33.1	31.8	30.6	29	40
44				31.9	30.6	29.5	28.2	27.1	25.6	44
48					27.5	26.4	25.2	24.2	22.7	48
52						23.8	22.6	21.6	20.2	52
56						21.5	20.4	19.4	18	56
60							18.4	17.5	16.1	60
64								15.8	14.4	64
68									12.9	68
72									11.6	72

## Load Chart of LJ

SCC3500A Crawler Crane — LJ										
Boom length 60m, Boom angle 85°, Jib length 24-72m, Rear counterweight 140t, Carbody counterweight 40t										
Radius (m)	24	30	36	42	48	54	60	66	72	Radius (m)
16	96.5									16
18	86.5	83.6	80.7							18
20	78.2	75.7	73.1	70.8						20
22	71.3	69	66.7	64.6	62.4					22
24	65.5	63.4	61.2	59.3	57.3	55.5	52			24
26	60.5	58.5	56.5	54.7	52.8	51.2	49.3	44.9		26
28	56.1	54.3	52.4	50.7	48.9	47.4	45.7	43.6	38.5	28
30		50.5	48.8	47.2	45.5	44	42.4	41	37.8	30
32		47.2	45.6	44.1	42.5	41.1	39.5	38.1	36.3	32
34		44.3	42.7	41.3	39.7	38.4	36.9	35.6	33.9	34
36			40.1	38.7	37.3	36	34.6	33.3	31.6	36
38			37.8	36.5	35.1	33.8	32.5	31.2	29.6	38
40			35.7	34.4	33	31.9	30.5	29.3	27.7	40
44				30.8	29.5	28.4	27.1	26	24.5	44
48					26.5	25.4	24.2	23.2	21.7	48
52						22.9	21.7	20.7	19.3	52
56						20.7	19.6	18.6	17.2	56
60							17.6	16.7	15.3	60
64								15	13.7	64
68									12.2	68
72									10.9	72

## Boom combination of LJDB

Boom combination of LJDB		
Boom length (m)	Jib insert	
	6m	12m
24	-	-
30	1	-
36	2	-
42	1	1
48	2	1
54	1	2
60	2	2
66	1	3
72 ★	2	3
78 ★	1	4
84 ★	2	4

**Note:**

The main boom configuration is the same as that in H configuration. Jib configuration includes: jib base, 6m tapered insert and jib top are mandatory.

Boom length with ★ must use mid-suspension cable, otherwise, the boom may break.

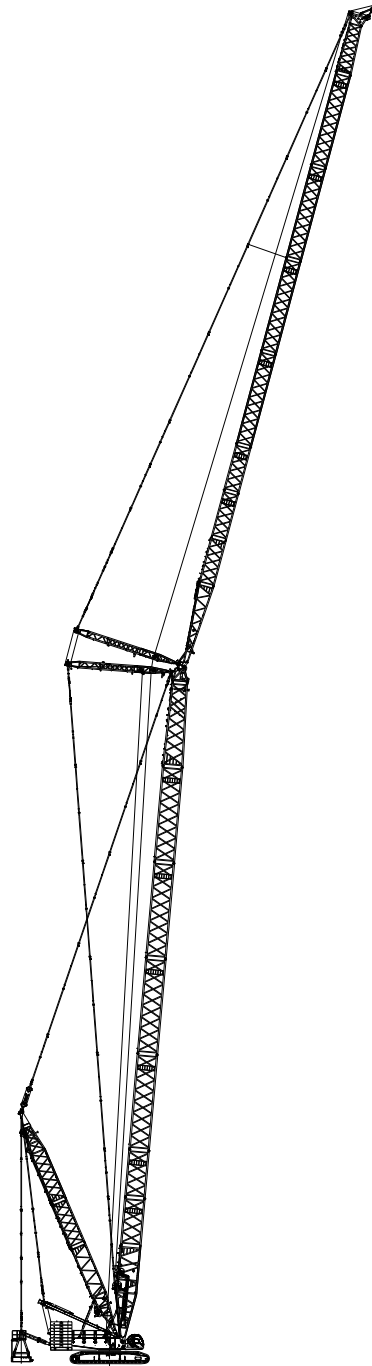

LJDB 84m+84m

**LJDB Work Radius**

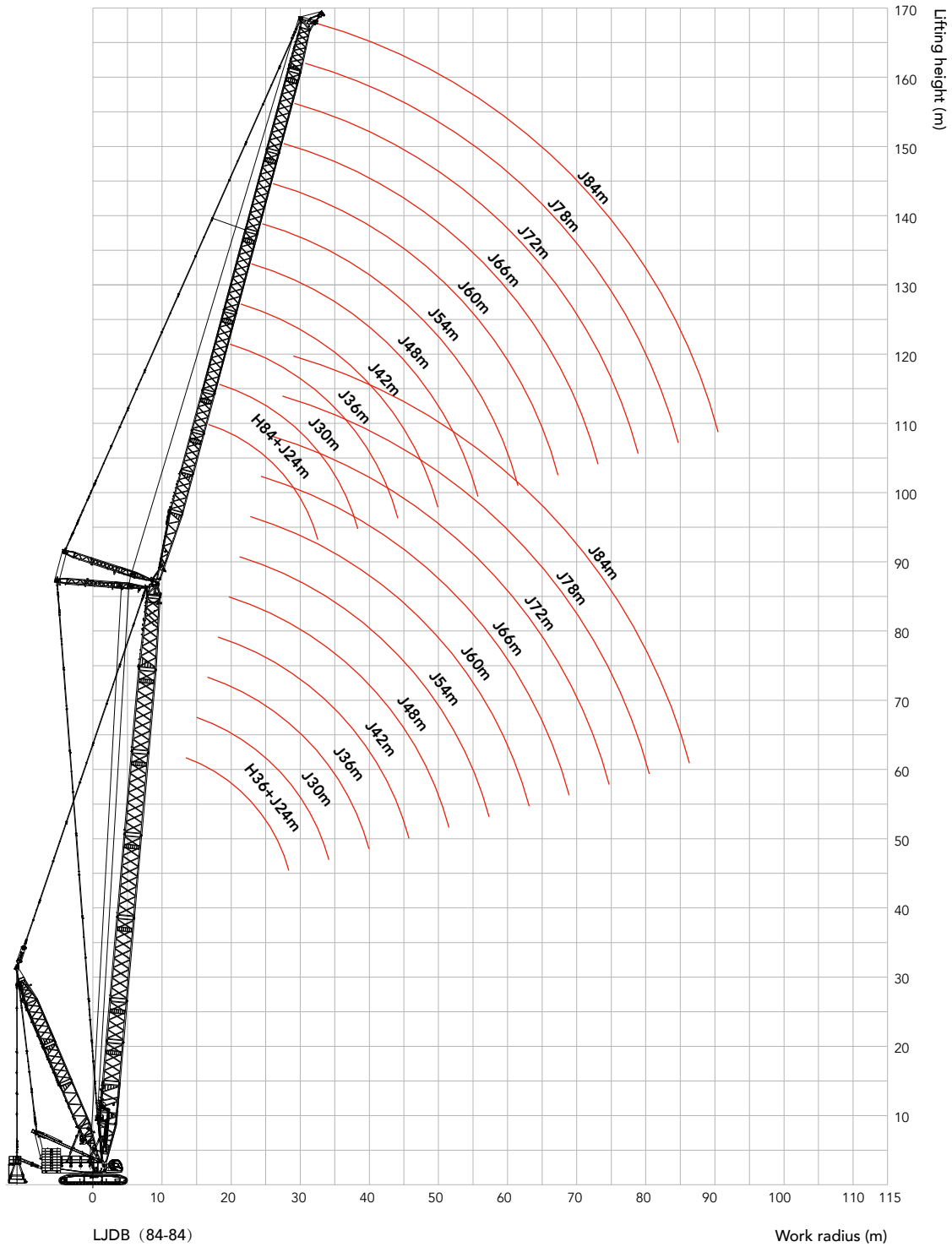



Unit: t

## LJDB Load Chart

SCC3500A Crawler Crane — LJDB												
Boom length 36m, Boom angle 85°, Jib length 24-84m, Superlift radius 15m, Superlift counterweight 200t, Rear counterweight 140t, Carbody counterweight 40t												
Radius (m)	24	30	36	42	48	54	60	66	72	78	84	Radius (m)
14	219.8*	200.1*										14
16	206.4*	196.4*	168.1*									16
18	190.4*	181.6*	160.2*	137.3*								18
20	175.7	167.6*	151.9*	131.8*	113.0*							20
22	164	157.1	143.3*	126.1*	109.1*	94.4*	81.0*					22
24	147.1	146.5	133.6*	119.5*	105.2*	91.7*	79.0*	68.0*				24
26	133.8	134.1	124.8*	113.6*	100.5*	88.3*	77.1*	66.8*	56.0*			26
28		121.9	115.6	106.8*	96.4*	85.5*	74.7*	65.4*	55.4*	46.3*	38.5*	28
30		111.7	106.9	100.0*	91.0*	82.2*	72.3*	63.7*	54.9*	45.7*	38.0*	30
32		101	98.8	93.3*	86.3*	78.3*	69.9*	62.0*	54.0*	45.1*	37.4*	32
34			91.2*	87.3*	81.6*	75.0*	67.6*	59.9*	52.8*	44.5*	36.9*	34
36			83.8*	81.4*	77.0*	71.2*	64.8*	58.2*	51.0*	43.8*	36.3*	36
38			76.9*	75.6*	72.6*	67.4*	62.1*	55.5*	48.1*	41.1*	35.2*	38
40				70.0*	68.0*	64.2*	59.4*	52.5*	45.3*	38.4*	32.6*	40
44					59.7*	57.5*	54.1*	46.6*	40.2*	33.6*	28.1*	44
48					52.2*	50.9*	48.6*	41.7*	35.7*	29.5*	24.5*	48
52						45.1*	43.6*	37.3*	31.6*	25.9*	21.0*	52
56							39.7*	33.5*	28.1*	22.9*	17.9*	56
60								30.2*	25.0*	19.9*	15.4*	60
64								27.0*	22.2*	17.3*	13.0*	64
68									19.9*	15.1*	10.8*	68
72										13.1*	8.8*	72
76										11.4*	7.2*	76
80											5.7*	80

## LJDB Load Chart

SCC3500A Crawler Crane — LJDB												
Boom length 54m, Boom angle 85°, Jib length 24-84m, Superlift radius 15m, Superlift counterweight 200t, Rear counterweight 140t, Carbody counterweight 40t												
Radius (m)	24	30	36	42	48	54	60	66	72	78	84	Radius (m)
14	169.4*											14
16	159.8*	139.5*										16
18	148.5*	132.3*	116.7*									18
20	137.0*	124.6*	111.2*	98.5*								20
22	125.8*	115.9*	104.7*	94.1*	83.5*	73.3*						22
24	114.1*	106.9*	98.7*	89.5*	79.9*	70.9*	62.5*					24
26	104.0*	98.8*	92.0*	84.3*	76.3*	68.4*	60.8*	53.8*				26
28	94.7*	90.7*	85.3*	79.6*	72.6*	65.8*	58.7*	52.3*	46.0*	38.7*		28
30		82.9*	78.8*	74.3*	68.8*	62.8*	56.9*	50.8*	45.0*	38.4*	32.1*	30
32		76.3*	73.1*	69.6*	65.1*	60.2*	54.4*	49.3*	43.9*	38.1*	31.8*	32
34		69.8*	67.7*	65.0*	61.3*	57.1*	52.3*	47.5*	42.6*	37.8*	31.5*	34
36			62.4*	60.5*	57.6*	54.1*	50.1*	45.6*	41.2*	36.8*	31.2*	36
38			57.4*	56.1*	53.9*	51.1*	47.7*	43.8*	39.9*	35.9*	30.8*	38
40				52.4*	50.4*	48.1*	45.2*	42.0*	38.3*	34.7*	30.4*	40
44				44.9*	44.3*	42.6*	40.6*	38.1*	35.3*	32.4*	28.9*	44
48					38.6*	37.8*	36.5*	34.6*	32.5*	30.0*	25.4*	48
52						33.2*	32.5*	31.2*	29.5*	27.0*	21.8*	52
56						29.3*	28.8*	28.0*	26.7*	23.6*	18.8*	56
60							25.7*	25.1*	24.2*	20.9*	16.2*	60
64								22.6*	21.8*	18.1*	13.7*	64
68									19.8*	16.0*	11.5*	68
72									17.8*	13.9*	9.5*	72
76										12.1*	7.7*	76
80											6.2*	80

Unit: t

## LJDB Load Chart

SCC3500A Crawler Crane — LJDB												
Boom length 72m, Boom angle 85°, Jib length 24-84m, Superlift radius 15m, Superlift counterweight 200t, Rear counterweight 140t, Carbody counterweight 40t												
Radius (m)	24	30	36	42	48	54	60	66	72	78	84	Radius (m)
16	110.7*											16
18	105.0*	94.4*										18
20	98.5*	89.2*	80.2*									20
22	91.4*	84.1*	76.3*	69.0*	62.0*							22
24	84.6*	78.5*	72.3*	65.8*	59.5*	53.4*						24
26	78.2*	73.0*	68.2*	62.6*	57.0*	51.7*	46.3*					26
28	72.3*	67.8*	63.7*	59.3*	54.4*	49.6*	44.9*	40.2*	35.0*			28
30	66.9*	62.8*	59.4*	55.7*	51.7*	47.5*	43.1*	39.0*	34.8*	29.6*		30
32		58.1*	55.3*	52.5*	48.7*	45.4*	41.4*	37.5*	34.0*	29.4*	24.7*	32
34		53.8*	51.3*	49.0*	46.1*	42.9*	39.6*	36.3*	32.8*	29.1*	24.5*	34
36			47.9*	46.0*	43.2*	40.7*	37.8*	34.8*	31.7*	28.6*	24.3*	36
38			44.3*	42.8*	40.7*	38.6*	36.0*	33.3*	30.5*	27.7*	24.1*	38
40			41.3*	40.0*	38.3*	36.3*	34.3*	31.8*	29.3*	26.6*	23.8*	40
44				34.9*	33.7*	32.3*	30.6*	28.9*	26.8*	24.7*	22.4*	44
48					29.4*	28.5*	27.5*	26.1*	24.4*	22.8*	20.9*	48
52					25.9*	25.2*	24.3*	23.3*	22.2*	20.7*	19.1*	52
56						22.2*	21.6*	20.9*	19.9*	18.8*	17.3*	56
60							19.2*	18.6*	17.9*	16.9*	15.8*	60
64								16.6*	16.0*	15.4*	14.2*	64
68								14.8*	14.3*	13.8*	12.1*	68
72									12.8*	12.4*	10.2*	72
76										11.1*	8.3*	76
80											6.7*	80
84											5.3*	84

## LJDB Load Chart

SCC3500A Crawler Crane — LJDB												
Boom length 84m, Boom angle 85°, Jib length 24-84m, Superlift radius 15m, Superlift counterweight 200t, Rear counterweight 140t, Carbody counterweight 40t												
Radius (m)	24	30	36	42	48	54	60	66	72	78	84	Radius (m)
18	82.7*											18
20	78.6*	71.1*	64.0*									20
22	74.1*	67.5*	61.5*	55.4*								22
24	69.3*	63.9*	58.6*	53.4*	48.0*							24
26	64.7*	60.0*	55.4*	51.0*	46.2*	42.0*	37.1*					26
28	60.4*	56.2*	52.1*	48.3*	44.2*	40.4*	36.5*	31.8*				28
30	56.1*	52.6*	49.0*	45.7*	42.3*	38.8*	35.2*	31.5*	27.0*			30
32		48.8*	46.0*	43.3*	40.1*	37.1*	33.9*	30.7*	26.7*	22.8*		32
34		45.7*	43.1*	40.5*	37.9*	35.3*	32.6*	29.6*	26.4*	22.6*	18.9*	34
36		42.4*	40.4*	38.4*	36.0*	33.6*	31.1*	28.5*	26.0*	22.3*	18.7*	36
38			37.5*	35.7*	33.9*	31.9*	29.5*	27.3*	24.9*	22.0*	18.5*	38
40			35.1*	33.5*	31.9*	30.1*	28.2*	26.1*	23.9*	21.7*	18.3*	40
44				29.6*	28.2*	26.8*	25.3*	23.7*	22.0*	20.1*	17.8*	44
48					25.0*	23.8*	22.7*	21.4*	19.9*	18.5*	16.7*	48
52					22.1*	21.1*	20.2*	19.3*	18.0*	16.8*	15.4*	52
56						18.9*	18.0*	17.2*	16.2*	15.2*	14.0*	56
60							16.1*	15.3*	14.6*	13.8*	12.8*	60
64							14.4*	13.7*	13.1*	12.4*	11.5*	64
68								12.3*	11.7*	11.0*	10.2*	68
72									10.4*	9.9*	9.2*	72
76										8.9*	8.1*	76
80										7.9*	7.1*	80
84											5.5*	84

**Boom combination of FJh**

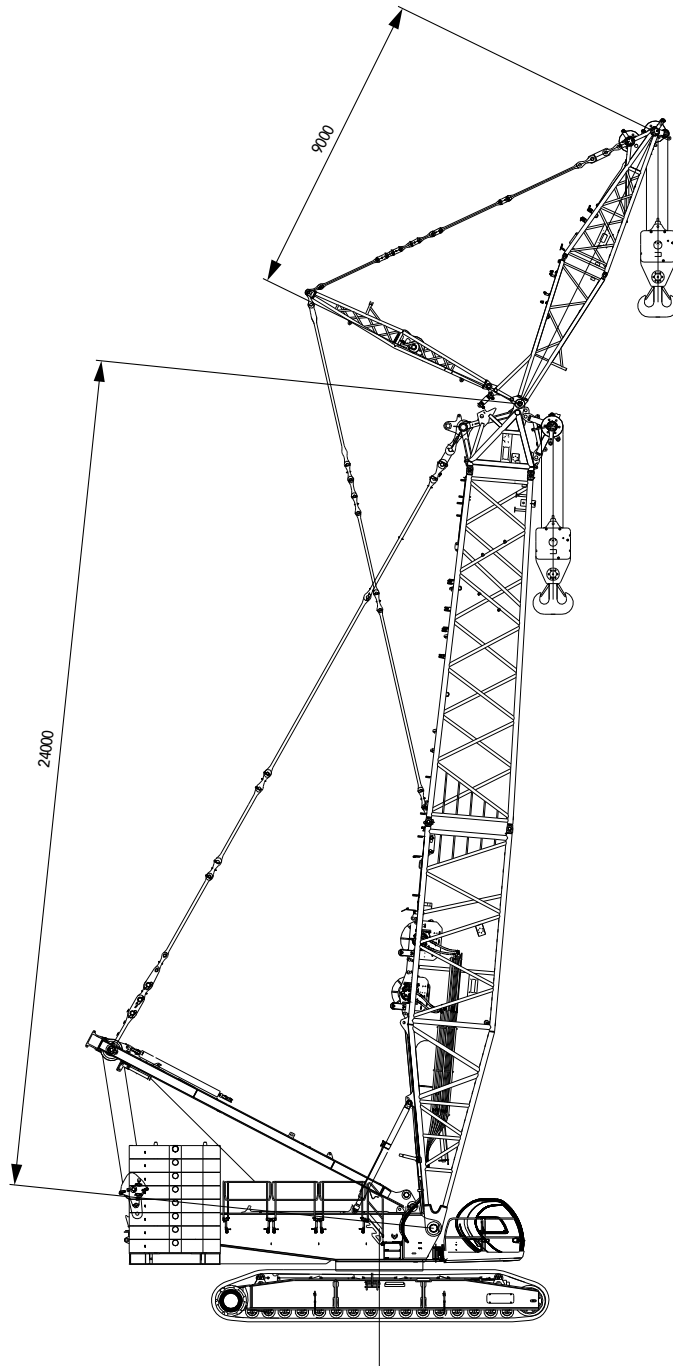

**FJh Work Radius**

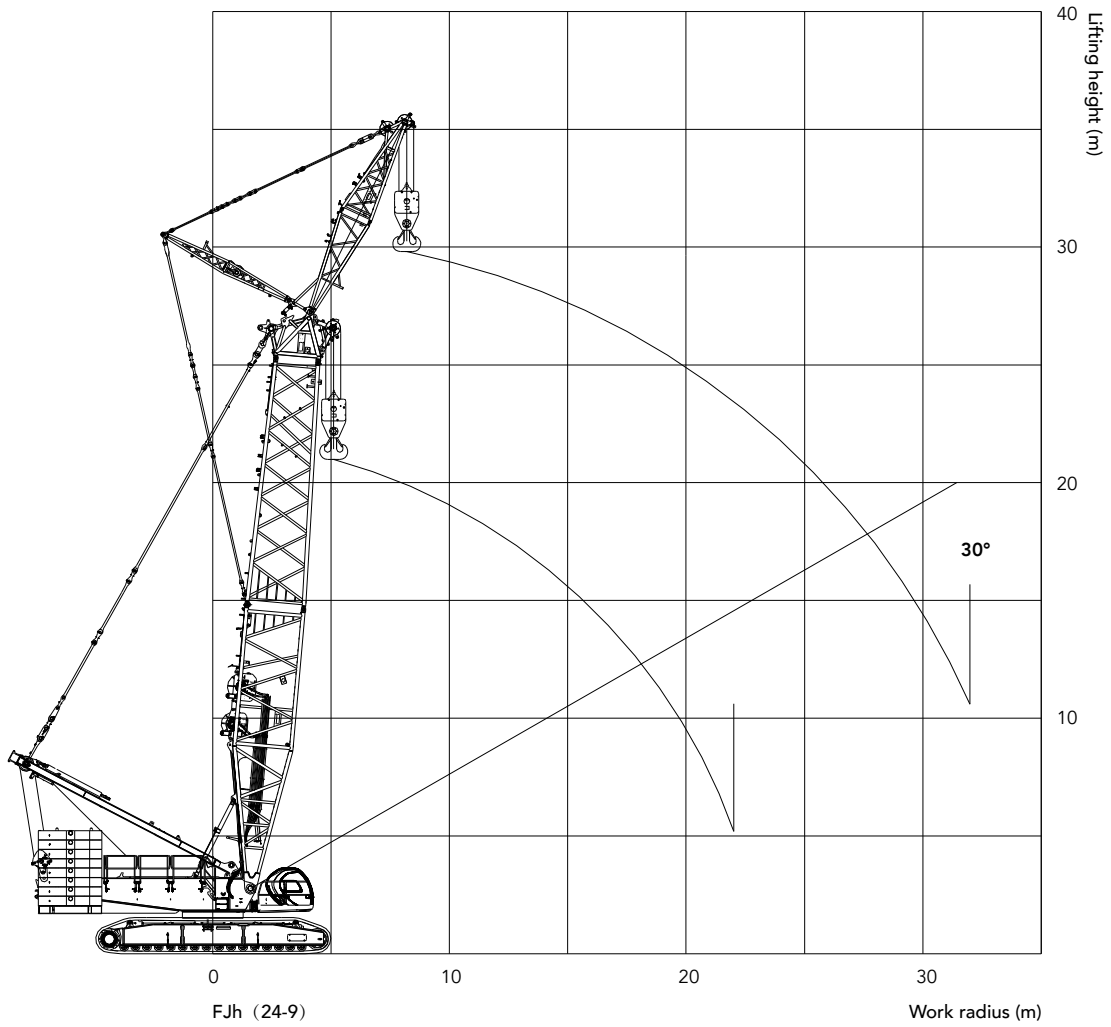

Unit: t

## Load Chart of H and FJH (boom to jib angle 20°)

SCC Crawler Crane Load Chart (H) V.0		
Boom length 24 Rear counterweight 140t, Carbody counterweight 40t		
Boom Length (m)	24	Boom Length (m)
Radius /m		Radius /m
6	320.0	6
7	315.0	7
8	282.5	8
9	251.7	9
10	219.7	10
11	190.5	11
12	165.9	12
14	131.2	14
16	107.7	16
18	90.8	18
20	78.0	20
22	67.9	22

**Notes:**

- 1.The rated capacity in the load charts includes the weight of lifting hook, etc.; therefore, the actual rated capacity is the value after deducting the weight of hook, riggings and wire rope reeved from hook block to the boom tip from the rated load in the load charts.
- 2.The rated capacity in the load charts is calculated when the crane is parking on firm and level ground and lifting the load slowly and steadily.



## Zhejiang SANY Equipment Co., Ltd.

SANY Industrial Park, No. 2087 Daishan Road, Wuxing District, Huzhou City,  
Zhejiang Province, P. R. of China Zip 313028

After-sales Service 400 887 8318

Consulting 400 887 9318

— Agent information —

Due to updated technology, the technical parameters and configurations are subject to change without prior notice. The machine in the picture may include additional equipment. This album is for reference only, subject to the object.

All rights reserved for Sany, without the written permission of Sany, the contents of any part of this content shall not be copied or copied for any purpose.

© Printed in May 2020 in China

[www.sany.com.cn](http://www.sany.com.cn)



Please scan the official  
WeChat account of Sany  
for more information.