

THE ULTIMATE IN COST-EFFECTIVENESS AND PRODUCTIVITY.

THE RS 600 AND RS 650 SOIL STABILIZERS / RECYCLERS.



MILLIONS OF KILOMETRES BEAR OUR SIGNATURE.

Any contractor involved in building roads, landscaping, or other earthworks projects needs to be able to do one thing above all: compact. And to help you achieve the best results, we build the best machines. For over 60 years, our company has helped write road construction and compaction technology history.

With our cumulative expertise, we have also set the pace for the entire soil stabilizer and recycler product sector. We have increased the utilisation of these machines with multiple new technologies. This protects resources and the environment and increases productivity. It also delivers

faster construction completion times.

Our specialists working around the world and our partners in more than 120 countries are on hand to support you, from the fitting out of machines to solving the most demanding challenges.

We owe our power of innovation to more than 2,500 committed employees worldwide. This expertise has made us the world market leader in compaction. We are driven by our total commitment to quality: during product development and production, in training our employees, and in providing a level of service which guarantees only the best on site support.

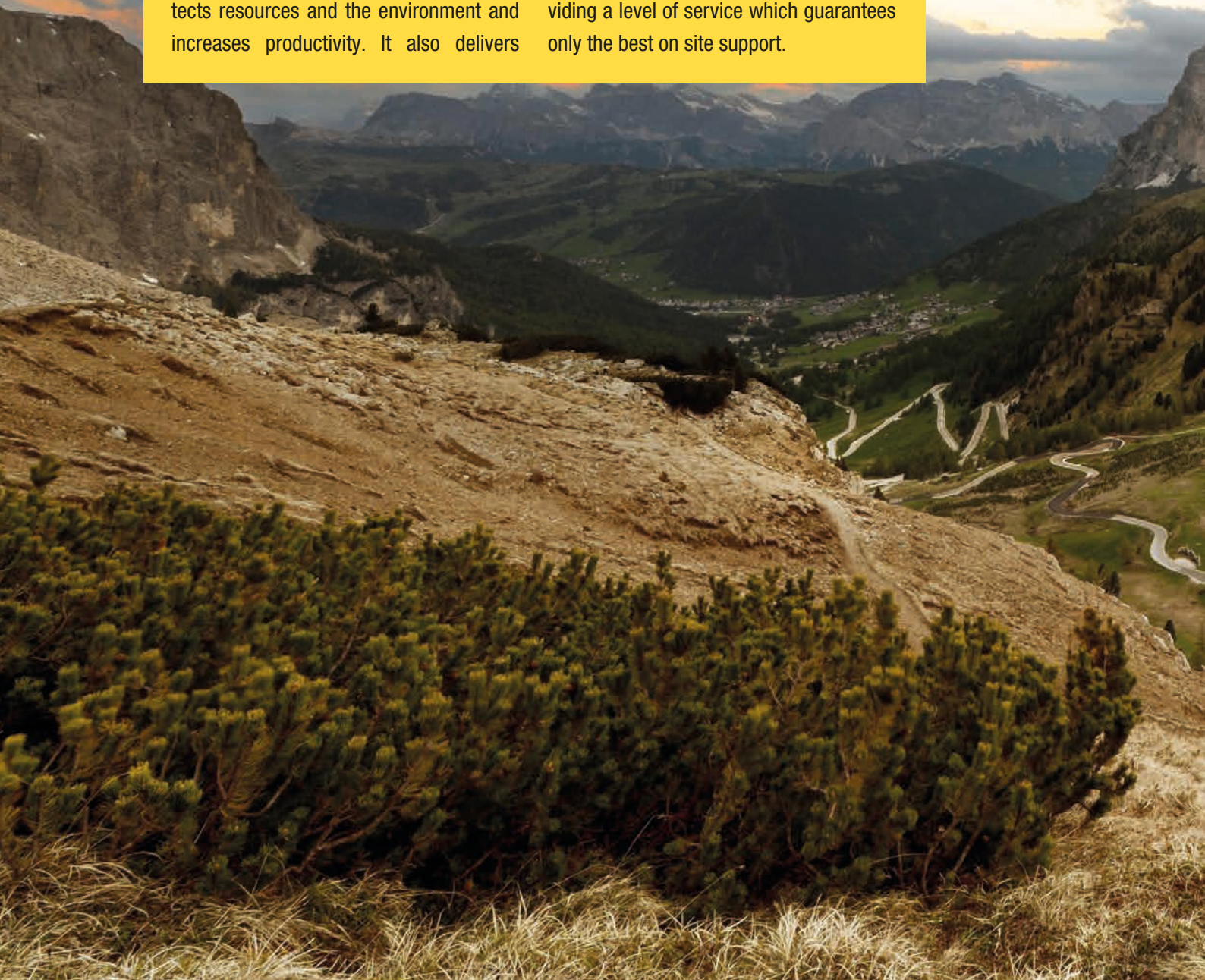



THE RIGHT SOLUTION FOR EVERY CONSTRUCTION SITE.

Choosing BOMAG means choosing expertise, quality and efficiency. With a choice of size or power, with 360 or 650 PS, BOMAG soil stabilizers and recyclers will handle every job to perfection. From car parks, roads, landfill sites and dam construction to industrial areas, major highways, railway tracks and airports – BOMAG recyclers are used on a wide variety of applications. Our unique, global product range is designed for a wide scope of application

such as crushing asphalt, soil stabilisation, or cold recycling. Our experienced international team of specialists ensure that we meet the requirements of every construction site and continuously innovate and lead.

Our design engineers' skills and expertise work for you to deliver top performance and reliability.



RS 650.



PRODUCTIVITY REDEFINED.

THE RS 600.

EASY MAINTENANCE

- Central lubrication system
- Reversible fan
- Compressed air system as standard

POWERFUL ENGINE FOR GLOBAL USE

- 8-cylinder engine
- Exhaust classification TIER 3

ULTIMATE EFFICIENCY

- Hydrostatic rotor drive; adjustable speed
- BSR 05 quick-change holder system



MAXIMUM SAFETY WITH OUTSTANDING ALL-ROUND VISIBILITY

- Height adjustable ROPS/FOPS cab
- Ultimate ease of operation

OUTSTANDING MIXING RESULTS

- FLEXMIX for highest quality with optimised costs
- Great flexibility in use with different materials
- Perfect mixing results forwards and reverse



POWERFUL TRACTION

- 1 pump and 3 travel motors
- Non-spin rear axle
- Powerful 4x4 all-wheel drive for permanent forward drive
- Anti Slip Control (ASC)

PRODUCTIVITY REDEFINED.

THE RS 650.

EASY MAINTENANCE

- Central lubrication system
- Reversible fan
- Compressed air system as standard

POWERFUL ENGINE FEATURING THE LATEST TECHNOLOGY

- 8-cylinder engine with dual SCR
- Exhaust classification TIER 4 final

ULTIMATE EFFICIENCY

- Hydrostatic rotor drive; adjustable speed
- BSR 05 quick-change holder system





MAXIMUM SAFETY WITH OUTSTANDING ALL-ROUND VISIBILITY

- Height adjustable ROPS/FOPS cab
- Ultimate ease of operation

OUTSTANDING MIXING RESULTS

- FLEXMIX for highest quality with optimized costs
- Great flexibility in use with different materials
- Perfect mixing results forwards and reverse

POWERFUL TRACTION

- 1 pump and 3 travel motors
- Non-spin rear axle
- Powerful 4x4 all-wheel drive for permanent forward drive
- Anti Slip Control (ASC)

POWERFUL, RELIABLE, AND COST-EFFECTIVE: THE TRAVEL SYSTEM.



The unique structure of our soil stabilizer with articulated and rear axle steering enables excellent handling even in the toughest conditions. The powerful 4x4 all-wheel drive with four identically sized wheels ensures excellent forward drive, even on deep, heavy ground.

- 1 pump and 3 travel motors
- Non-spin rear axle
- Powerful 4x4 all-wheel drive for permanent forward drive
- Anti Slip Control (ASC)

However, what is output power without ground contact? The machine's great stability is safeguarded by the oscillating rear axle. Ground contact is guaranteed at all times. The machine's low centre of gravity ensures stable driving conditions even under extreme driving situations.

- Permanent ground contact thanks to the oscillating axle
- Safe work due to the low centre of gravity
- Articulated steering for difficult driving situations



Non-spin oscillating axle +/- 15°.

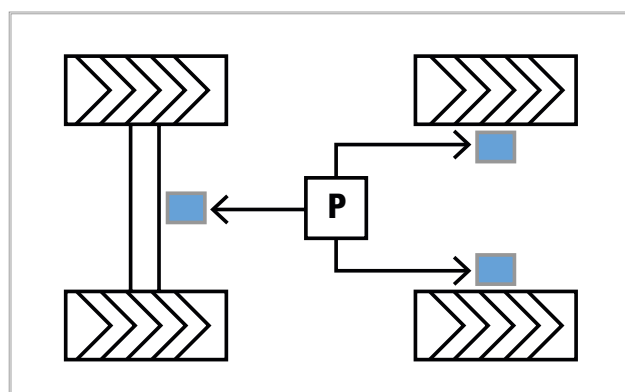

1 pump, 3 travel motors.



Small turning radius.



Work close to obstacles.

unbeaten in its class. With excellent all-round view, the operator is able to turn the machine quickly and safely even in confined conditions or on embankments.

With its rotor centrally positioned in the direction of travel, the RS 600/650 works both the left and right-hand side of the milling edge with full reliability. The time saved can then be put to use in milling output.

Its unique steering concept with four different steering modes allows the soil stabilizer to achieve a turning radius

- Work on the left and right-hand side milling edge
- Increased daily output by reduced turning times and reverse manoeuvres

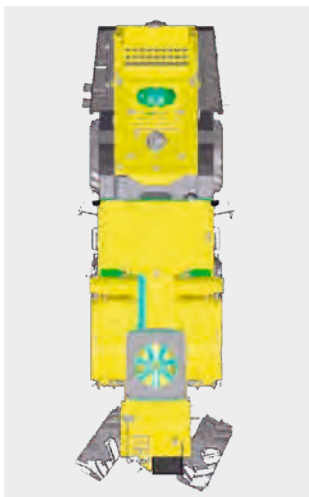

Rear axle steering.



Articulated steering.

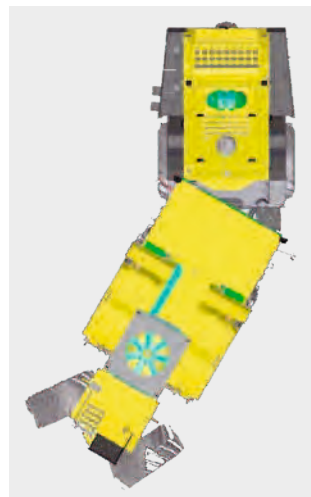

Synchronous steering.



Asynchronous steering. (Crabwalk)

HYDROSTATIC ROTOR DRIVE.

EFFICIENT ROTOR DRIVE.

The RS 600 and RS 650 are equipped with a hydrostatic rotor drive. The 11-increment rotor speed can be continuously varied from the driver's seat. This guarantees the best mix quality with low wear and less fuel consumption. A milling and mixing rotor driven by two planetary gear units provides maximum traction for all applications. In milling mode, the rotor speed is almost infinitely variable (11 increments), which means tool and rotor wear can be kept to a minimum. By adjusting the rotor speed easily to a work situation, the best mixing result is achieved with the lowest fuel consumption.

Key advantage: the hydrostatic rotor drive overload protection system also provides high machine availability on the toughest sites. It blocks automatically if obstacles are encountered that could cause the drive to overload; for example, buried objects, old tramlines, or manhole covers. In the process, the pressure relief valves open, preventing damage to the mechanical gearbox.

The hydraulic rotor drive is not exposed to contamination as no debris and dirt can get in. In addition, it is maintenance-free.



The hydraulic overload protection system prevents unwanted surprises.

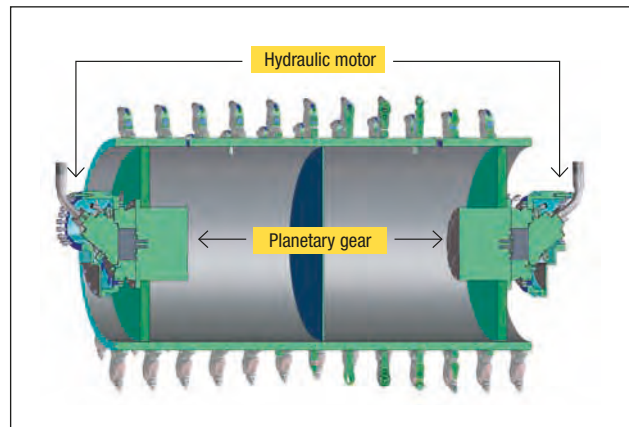

Wear and maintenance-free rotor drive.

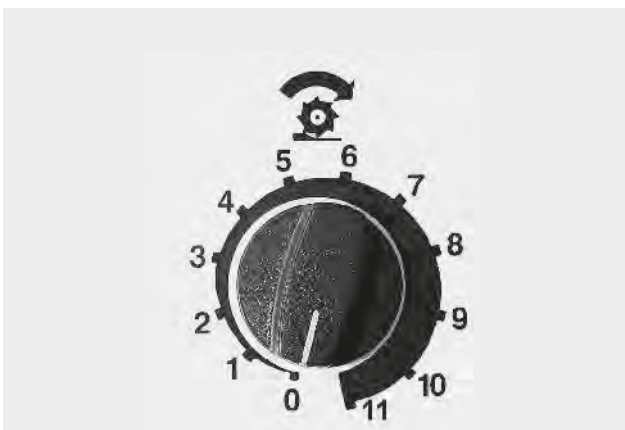

11-Increment rotor speed means efficient work.



Hydraulic drive.

NOTHING MIXES AND CRUSHES BETTER.



Unique to BOMAG: There are three infinitely adjustable gates on the rotor hood. Apart from the standard configuration options for the front and rear gate, BOMAG offers an additional mixing and crushing gate in the rotor hood.

If required, the milled material is crushed to the target size by the mixing bar. Infinite, variable adjustment of all three gates means any required result is achieved easily

and safely. No matter whether maximum mixing output or enhanced quality is required, BOMAG FLEXMIX technology always has the right setting.

- Great flexibility in use with different materials
- Perfect mixing results thanks to BOMAG FLEXMIX technology

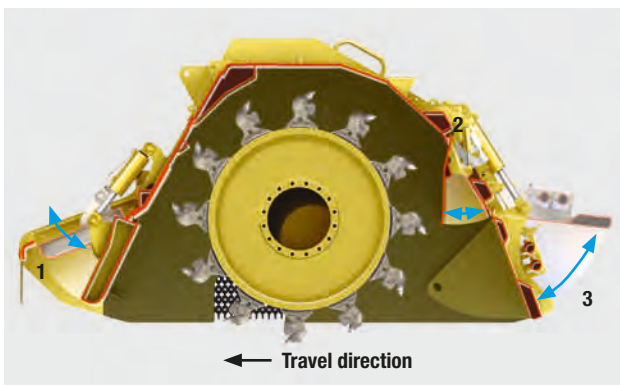

1) Front and crusher gate; 2) mixing and crushing gate; 3) rear and operating gate.

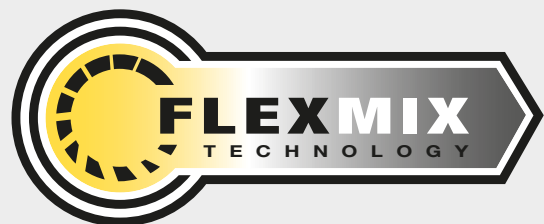

AT THE CUTTING EDGE: THE ROTOR.

Low wear, excellent accessibility and the quick changing times for expendable parts have set new standards in availability and productivity. The rotor's great weight provides maximum centrifugal mass for difficult crushing work. In addition to the standard width of 2,400 mm, an optional rotor is available with a width of 2,600 mm.

CHANGE WEAR PARTS SAFELY AND FAST.

During a tool change, operator safety comes first. All machine functions can be deactivated with a tool change

switch. The operator can then turn the rotor in both directions. In this case, the rotor hood is also secured to prevent lowering. Working lights provide ample light under the rotor hood even at night. The compressed air system, which comes as standard, enables the use of pneumatic tools, making daily maintenance work easier. To protect the rotor edge, the rotor has four segments which can be individually exchanged without complete removal of the rotor. This saves time and money and increases availability.



Tool change switch.



Easy monitoring of the rotor with a safety gap between the control unit and rotor.

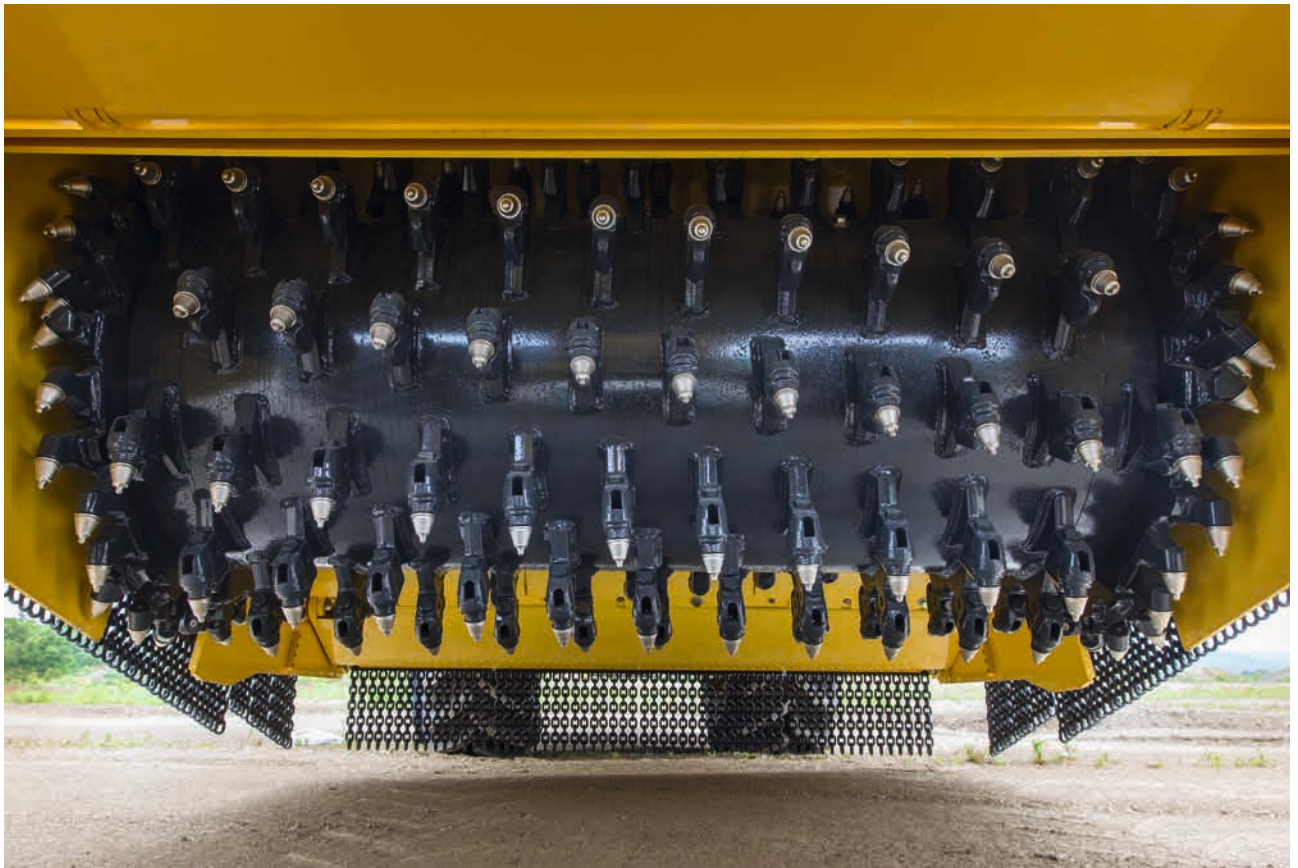

NEW STANDARD FOR TOOL HOLDERS.

Never compromise – the standard set for the development of the new BOMAG BRS 05 quick-change holder system. Increased cost-cutting plays a leading role.

The system, designed for use on soil stabilizers and recyclers, ensures low costs and quick changing times, even under difficult site conditions. The positive connection between both elements guarantees safe operation even under maximum loads.

- Maintenance-free design for easy handling
- Positive connection for absorbing the high forces; the screw only serves as a safety device
- Long service life by the use of highly wear-resistant steel

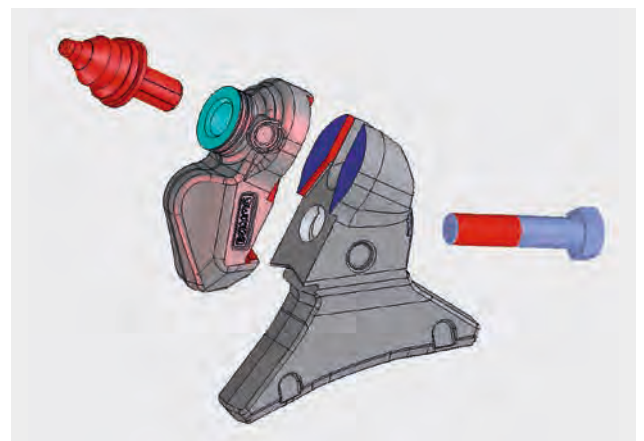

BOMAG BRS 05 quick-change holder system.



Changing the edge segments without having to remove the rotor.

CONVENIENCE AND SAFETY.

EXCEPTIONAL COMFORT FOR LONG WORKING SHIFTS.

A symmetrically designed machine with the rotor placed centrally within the frame in the direction of travel allows work on the left and right milling edge. This requires an ergonomic working position for the operator on both sides.

The ROPS-FOPS cab allows the workplace to be shifted within the cab. The seat can be turned 45° to the left or right, providing perfect ergonomics and safe and fatigue-free work, even on long shifts.



Ergonomic work position for fatigue-free work.



Intuitive work thanks to clear displays and symbols.



Two joysticks on the arm rests for easy handling of the machine.

SAFETY IN ANY POSITION.



On busy sites everything remains in sight. The high-up work position of the cab and large windows provide a perfect view of the worked edges. This offers the best view around the machine and safe manoeuvring. The flexible rotation of the seat supports this.

The 8 LED lights installed as standard around the machine and the two additional working lights on the cab provide excellent illumination during work at night.

The camera system, which comes as standard, provides additional safety in the RS 600 and RS 650. Two cameras provide a 180-degree view to the left and right of the machine; two further cameras monitor the work space in front of and behind the recycler. They transmit live images to a monitor, which is easily in view at all times.

The 3 emergency stop switches distributed around the machine ensure utmost safety.

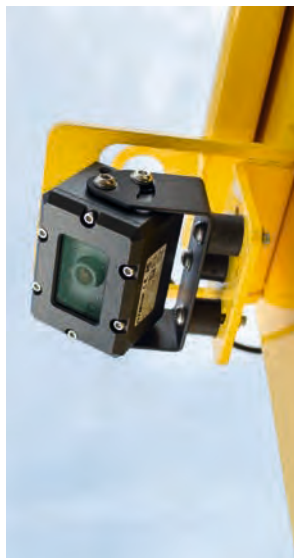

Everything is optimally illuminated during night work.

Cameras and a monitor provide the perfect all-round view.

ENGINE.

TOP PERFORMANCE WITH PIONEERING TECHNOLOGY.

The powerful 8-cylinder engines make BOMAG soil stabilizers the champions of their class. They are true power packs, capable of shunting a bitumen emulsion tanker of around 40 t during the mixing process, whilst towing a water tanker of around 30 t behind.



RS 650 Stage IV / TIER 4 final

TCD 16.0
480 kW / 653 PS @ 1900 min-1

RS 600 Stage 3a / TIER 3

TCD 2015
440 kW / 590 PS @ 1900 min-1





TIER 4 final with dual SCR system.

Thanks to the latest engine technology, the RS 650 meets the strict emissions standards of EU Stage IV/TIER 4 final. It features a Deutz engine with 653 PS that provides top performance as well as having the lowest exhaust emissions.



TIER 3.

The RS 600 model is available for use worldwide. The Stage 3a/TIER 3 machine with a 590 PS Deutz engine is designed for all local fuel qualities for maximum availability.



Fuel pre-filter comes as standard.

Both engine types come as standard with a fuel pre-filter fitted, which prevents dirt particles or water from entering the injection system and ensuring that clean fuel is always available.

MAINTENANCE AND SERVICE.

EASY MAINTENANCE INCREASES PRODUCTIVITY.

MAINTENANCE CONCEPT.

The powerful engines are impressive performers; the hydraulic radiators are always ready for operation. The radiator is controlled according to temperature, which ensures optimum energy efficiency.

If necessary, the fans can be reversed at the push of a button, blowing the dust or larger particles out of the

radiator and ventilation grilles. This reduces the cleaning effort and increases the machine's working time. However, if cleaning is necessary, the high-volume radiators can be easily cleaned using compressed air available from the compressor, which comes as standard. This ensures high availability and low wear.

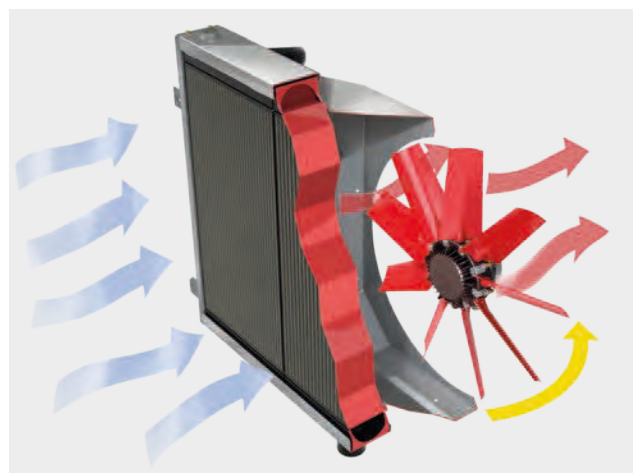
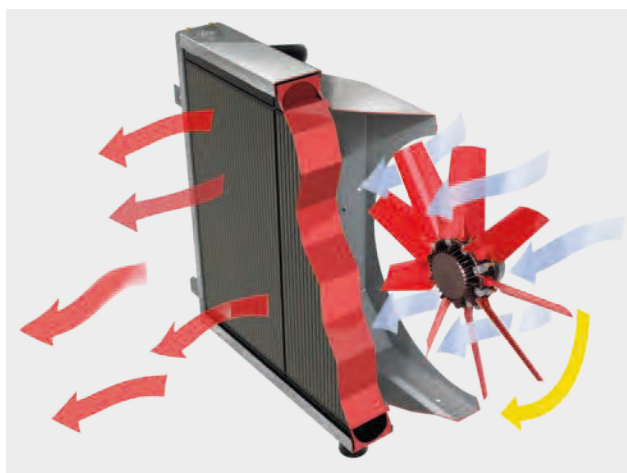

Reversible fans for less cleaning and greater utilisation.

MAINTENANCE CONCEPT.

Our guiding principle is: the best maintenance is low maintenance. The central lubrication system, which is supplied as standard, ensures all the components run smoothly. The lubricant container with agitator is equipped with an automatic interval function, allowing air-free conveyance.

The wide-opening engine hatches allow easy access to the radiator, filter and service points. Large and easily accessible storage spaces make the transportation of wear parts easy. By the same token, access from the ground allows safe handling.



All service points are easy to access: water filter, AdBlue, and the central lubrication system.

ACCURATE METERING, PERFECT RESULTS.

WATER INJECTION SYSTEM.

The fully automatic water injection system ensures perfect moisture content in the soil. A high precision flow measuring system provides ultimate accuracy. The spray widths can be individually set on the metering computer to prevent over-watering in the case of overlapping milled tracks. The system is equipped with an automatic cleaning system to prevent the nozzles becoming blocked.

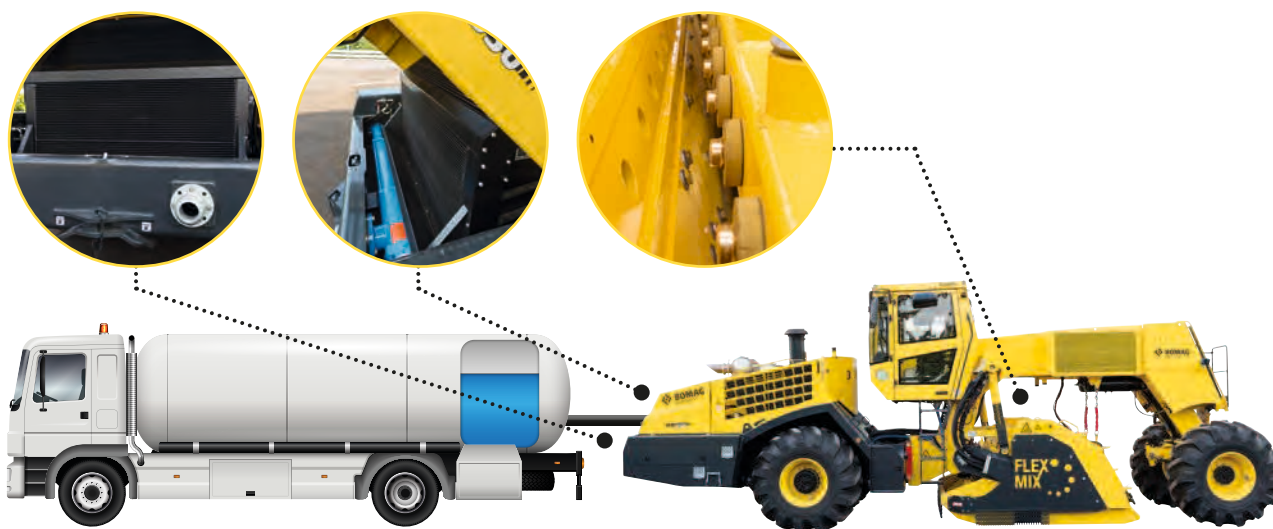

METERING COMPUTER AND PRINTER.

The metering computer is responsible for controlling the injection system. The buttons make it easy to operate and the operator has everything in sight at all times. Control is manual or automatic; the 10 spray sections can be switched on and off individually. The metering computer also records the relevant injection data continuously. This

can be printed out in the cab using the optional printer, e.g.:

- Working mode
- Surface coverage
- Injection quantities of water and bitumen



The metering computer – everything always in sight.



Printer optionally available.

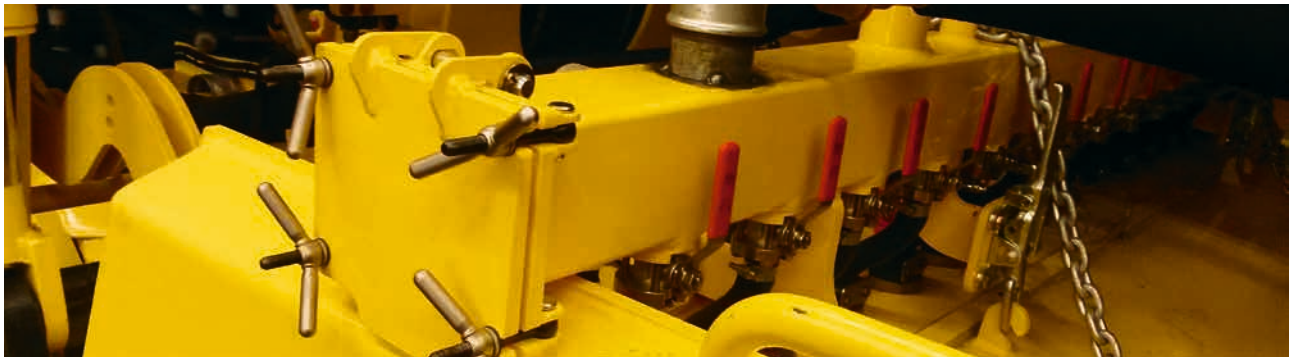

CEMENT SUSPENSION.

The mixing vehicle, pushed by a bar by the recycler, pumps and meters the suspension through the pre-filter in the recycler. In the process, unwanted coarse particles are filtered out. The suspension is then conveyed to the spray bar by a total of 20 manually switchable nozzles. A cleaning lance can be used to easily clean the filter and spray bars.



BITUMEN EMULSION.

Cold or up to 60 °C hot bitumen emulsion is injected and metered fully automatically by a hydraulically driven auger pump. The 20 nozzles in 10 sections can be switched on and off in each section. If bitumen emulsion and water are added in the process, two precision pumps controlled by the metering computer operate separately from one another for the perfect result.

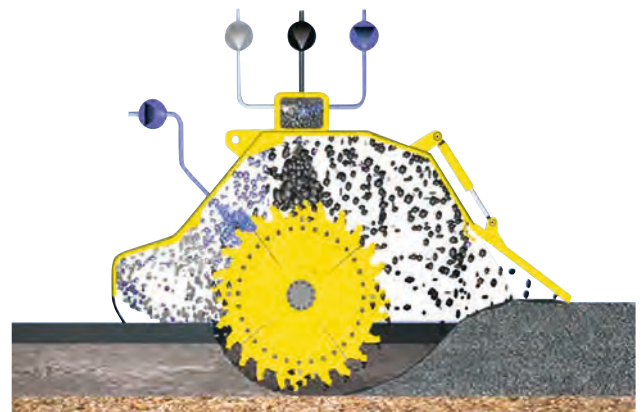

FOAMED BITUMEN.

During cold recycling, a new bearing course is produced with the addition of foamed bitumen. In the process, hot 180 °C bitumen is foamed with water and air and then mixed with the pulverised asphalt. The heating system and circulation system constantly provide the right temperature for the foamed bitumen system, even if a short stop is made to fill up.

BOMAG EFFICIENCY.

FOR 100% FLEXIBILITY ON THE JOB.



MACHINE TRANSPORTATION MADE EASY.

In addition to the excellent all-round view, the height adjustable ROPS-FOPS cabin also provides for a low transportation height. A switch in the cab can be used to quickly lower the unit to transportation height. This makes it easier to move the machine and transport it on public roads.

It also reduces the effort involved in obtaining special permits or low-loaders, which saves both time and money.

EFFICIENT FLEET MANAGEMENT.

BOMAG TELEMATIC also provides efficient, transparent fleet management. This lets you know, for example, where machines are located, how they are being used, how high fuel consumption is, and when maintenance work is due. If necessary, fault codes can be read using the teleservice and appropriate action taken.





WIDE ROTOR.

For even greater surface coverage, the machine can be fitted with an optional 2,600 mm wide rotor. This is equipped with a total of 212 cutting tools and has a maximum working depth of 600 mm.



SERVICE KIT.

Making it easy for you: Everything you need for the maintenance of your machine is delivered in one useful package. BOMAG service kits are available individually for your machine. We've already done the time-consuming task of putting the parts together. You require just one order number for essential parts in proven BOMAG quality. This saves you time, prevents incorrect deliveries, and gets your machine up and ready for work again quickly.

SERVICE AT YOUR FINGER TIPS.

Looking for a spare part or the nearest BOMAG service partner? With the free BOMAG Service app you can quickly access spare parts lists, technical data, operating and maintenance instructions and videos – just enter your machine serial number. Download it now.



BOMAG EXPERTISE.

A GLOBAL SUCCESS STORY.

Soil stabilisation has established itself as standard in many countries, particularly over the last few years. However, applications vary greatly depending on the country. The RS 600/650 soil stabilizer/recycler meets global requirements and ensures the lowest operating costs in its class.





...AND THE HIGH DEMANDS OF RECYCLING.

Contract specifications and workloads are especially high with cold recycling. In such conditions, the RS 600/650 has proved its unique flexibility and productivity on sites around the world to become the machine of choice in meeting the highest demands.

MODEL OVERVIEW.



RS 360



RS 460



RS 500



RS 600



RS 650

TIER 4 FINAL	Engine output	Operating weight	Working width	Working depth
RS 360	261 kW	17,690 kg	2,005 mm	305 mm
RS 460	340 kW	24,150 kg	2,440 mm	500 mm
RS 500	380 kW	24,900 kg	2,250 mm	500 mm
RS 650	480 kW	27,900 kg	2,400/2,600 mm	600 mm

TIER 3	Engine output	Operating weight	Working width	Working depth
RS 360	268 kW	17,690 kg	2,005 mm	305 mm
RS 460	335 kW	24,150 kg	2,440 mm	500 mm
RS 500	375 kW	24,900 kg	2,250 mm	500 mm
RS 600	440 kW	27,900 kg	2,400/2,600 mm	600 mm

Technical modifications reserved. Machines may be shown with optional accessories.



BOMAG
FAYAT GROUP

BOMAG
FAYAT GROUP

RS650I

