



EASILY THE BEST COMPACTION.

FOR PROFESSIONALS: BOMAG LIGHT EQUIPMENT.



MILLIONS OF KILOMETRES BEAR OUR SIGNATURE.

You mend, repair and create so that our environment remains worth living in. To make this work easier for you we build the best machines – from tampers and vibratory plates to hand-guided vibratory rollers and multi-purpose compactors. For over 60 years, the history of our company has been synonymous with the history of compaction.

With our accumulated know-how, we are an innovation driver that sets the pace for an entire industry. BOMAG has developed a huge number of technologies, from systems for measuring and improving compaction, such as the ECONOMIZER, to technologies for reducing operating costs, such as ECOMODE. We offer effective solutions for a wide range of applications, for example, the unique STONEGUARD technology which

prevents block paving from fracturing during vibratory compaction.

Our global network of experts and partners in over 120 countries is there to support you, from the configuration of the machines to providing solutions for the most challenging tasks.

We owe our innovative strength to our more than 2,500 employees worldwide, their commitment and their unique wealth of experience. A source of know-how which has propelled us to worldwide market leadership. The reason for this is our commitment to quality: in product development and production, in the qualification of our employees, and in a service that guarantees optimal on-site support.





COMPACTION MEANS BOMAG.

If you work your sites hard, you need machines you can rely on. That's why at BOMAG we have specialised in easy handling, robust and safe equipment for decades. And this will never change.

HITTING IT BIG WITH SMALL MACHINES.

When BOMAG built the BW 60, the world's first hand-guided double vibratory all-drum drive roller in 1957, the model became a milestone in compaction performance.

The close relationship with our customers back then allowed us, as it still does, to develop machines and systems that make site-work easier. This legacy is something customers around the world value and is the reason the industry places its trust in BOMAG.



TABLE CONTENTS.

06	TAMPERS
14	SINGLE DIRECTION VIBRATORY PLATES
20	REVERSIBLE VIBRATORY PLATES
28	HAND-GUIDED VIBRATORY ROLLERS
34	MULTI-PURPOSE COMPACTORS
42	BOMAG GENUINE PARTS AND SERVICE
44	PRACTICAL TIPS FOR EARTHWORKS AND ASPHALT
46	PRACTICAL TIPS FOR PAVING WORK
48	MODEL OVERVIEW

READY. STEADY. RUN.

WORK AT EASE. BOMAG TAMPERS.

Stress-free operation: switch on, start up, and off you go. With a robust design, intuitive operation, and safe handling, BOMAG

tampers are first choice on every construction site.

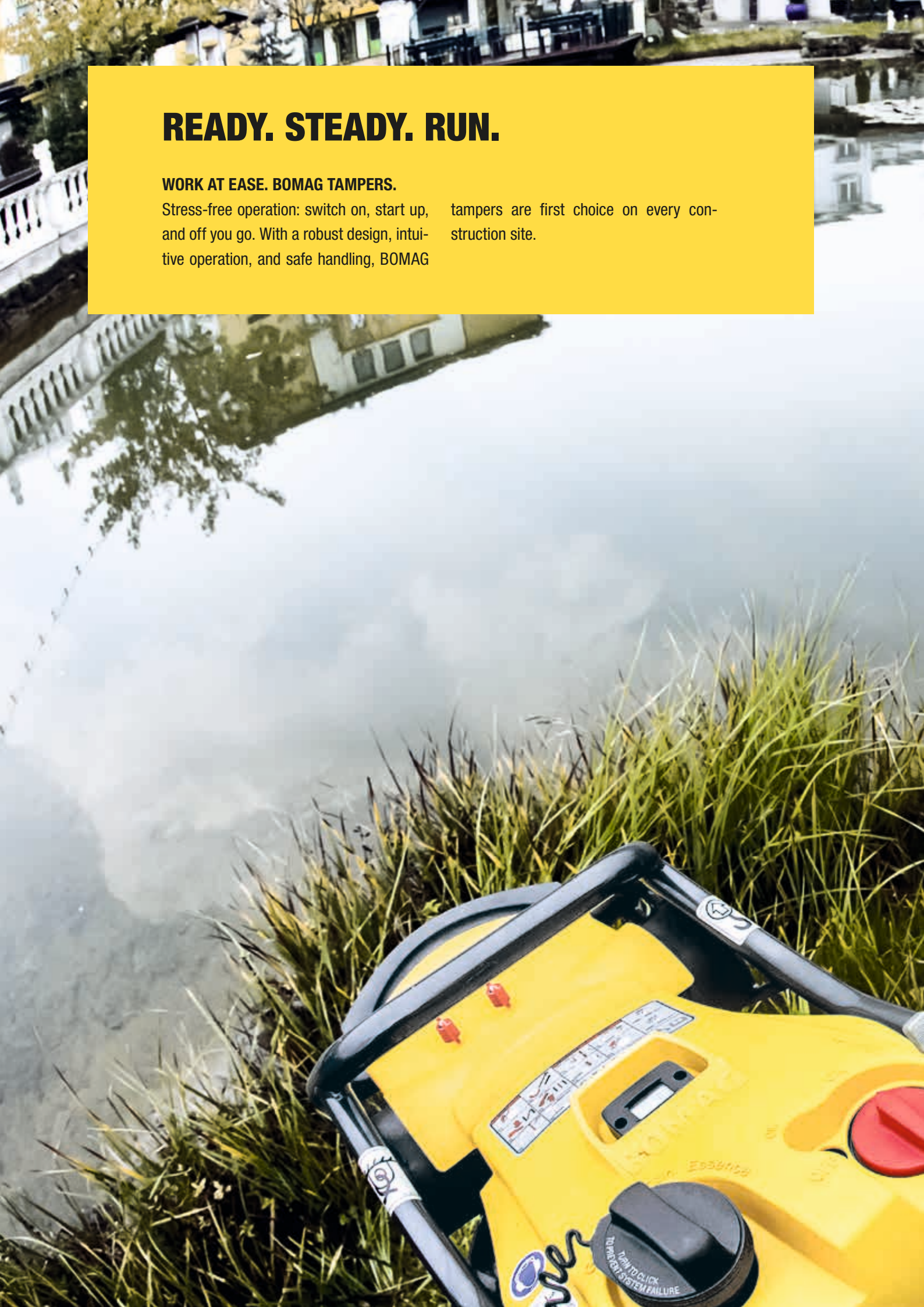



FOUR STROKE WINNER.

Robust, reliable and extremely tough: these 4-stroke engine BOMAG tampers are ideal for trench and sewage systems, gardening and landscaping, compaction on backfill, foundations, patching and repairs. Less effort to operate, durable, designed to deliver high performance.



**A POWER-PACKED UNIT:
MODEL BT 65 FOR MAXIMUM
COMPACTION PERFORMANCE.**

The most powerful tamper in its class: for heavy-duty usage, the best compaction results and overall efficiency. The reference class for professional users.

**LIGHT WEIGHT MODEL: BT 60
CONVENIENT HANDLING AND
LESS DOCUMENTATION EFFORT.**

The lightest tamper in this performance class: ideal for long working shifts in confined spaces. The BT 60 also has the lowest hand-arm vibrations: $< 5 \text{ m/s}^2$ in the standard version. The reference class for professional users.



**BASIC MODELS: BVT 65 FOR
ALL-ROUND COMPACTION
PERFORMANCE.**

Sets the standards in the premium class: for economic use on a wide range of applications. BOMAG performance: outstanding design.



**DIESEL POWER: MODEL BT 80 D
FOR THE MOST CHALLENGING
CONDITIONS.**

Diesel power for extended use on tough sites. The specialist model for demanding jobs needing extra impact forces and productivity.



ROBUST IN THE DETAILS.

WELL-LUBRICATED

A unique BOMAG lubrication system provides optimum oil supply in the crankcase at all angles. The engine is also protected by the automatic oil level check system.

LONGER SERVICE LIFE

The two self-cleaning, paper air filter systems allow the petrol-operated machines of the BT series to achieve maximum availability and extended service life.



QUICK TO MOVE

Optional transport wheels for easy handling around site.



ALL AT A GLANCE

Operating hour counter, tachometer and resettable service display, daily hour counters provide a clear overview.

SAFE OPERATION

The height adjustable, anti-vibration guide handle can be adjusted to suit every operator. Ensuring fatigue-free work.



EVERYTHING UNDER CONTROL

ON/OFF safety easy-action switch for prompt engine and fuel start-up and shutdown.

FULLY PROTECTED

The engine protection cover provides optimum damage protection on-site. Even heavy-handling off the delivery truck won't damage the durable plastic, reducing repair costs by up to 33%.

Working in deep trenches or enclosed spaces? No problem with the new reduced-CO emission BOMAG tamper models. And for users wishing for even greater safety and environmental features, the BOMAG G series is the answer. The gas drive unit means only negligible amounts of CO are produced. A practical solution for challenging job conditions.



NOT JUST CLEAN, BUT PRISTINE.

Some jobs present bigger challenges than others: e.g. enclosed spaces or deep trenches. The first gas-operated tamper worldwide from BOMAG meets the highest health and safety demands for extreme site conditions.

BREATHE EASILY:

BOMAG offers the first worldwide models driven by gas, the BT 60 G and BT 65 G tampers. These units excel with almost untraceable CO emissions. They are highly environmentally-friendly and safeguard operator health under extreme job conditions.

These tampers are equipped with the latest 4-stroke engines fuelled by standard propane gas. The two safety bottles can be filled and re-filled with ease on site. A full tank will give 2 hours' operation.



Technical modification may be required in certain markets.

ALWAYS ON THE MOVE. ON ANY SURFACE.

PRESS AHEAD. WITH BOMAG SINGLE DIRECTION VIBRATORY PLATES.

You can trust BOMAG quality and performance on all small site operations. High output. Reliability. For earthworks, bases,

asphalt or block paving. And now we've made our small plates even more robust.





QUALITY COMPACTION.

BOMAG single direction vibratory plates are designed for use on all earthworks, asphalt and paving applications. The range offers the right solution every time plus extra BOMAG reliability and compaction power.

LIGHTER WEIGHT MODELS: MODELS BP 10/35 AND BP 12/40.

For a fast repair, small area or patching job. These units offer easy handling and economic operation. Especially useful in tight corners or on areas difficult to access.



THE ASPHALT SPECIALIST: MODELS BP 12/50 A AND BVP 12/50 A.

Fitted with a special base plate, this unit is ideal for all asphalt applications. No scuffs on the asphalt surface when turning. This model gives a perfect surface finish.



POWER-PACKED UNITS: MODELS BP 20/50, BP 20/50 D, BP 25/50 AND BP 25/50 D.

These are the right plates for the specialist user who needs to meet the highest compaction demands every time.



MULTI-TALENTS:

MODELS BVP 10/30, BVP 10/36 AND BVP 18/45.

These compact, versatile units are indispensable for day-to-day use on the most frequent applications in repair and maintenance works, earthworks, asphalt and paving. Developed for contractors who demand BOMAG quality!



THE GREATNESS IS IN THE DETAILS.

OPTIMALLY CUSHIONED

The hinged guide handle is mounted on large 'silentblock' rubber mounts. This reduces hand-arm vibrations to less than 5 m/s^2 on both the BP and BVP series. In addition, optional comfort handles are available with hand-arm vibrations $\leq 2.5 \text{ m/s}^2$. This makes things easier for the operator and reduces the documentation effort.

EASILY HANDLED

The transport handles guarantee a safe grip on all models for loading.



SENSITIVELY COMPACTED

Optional plastic mats provide optimum protection against damage of the pavement surface. A clear advantage on coated surfaces. Available for all models.

BUILT TOUGH

For tough-going: the protective frame is designed to protect the engine and other components from impacts, mishaps and rough handling.

QUICKLY FILLED

The removable water tank on the BP series has a larger capacity and is even equipped with a level indicator.



MADE SAFE

The V-belt guard, standard on all models, provides the operator with permanent protection from injury and the fully enclosed design results in fewer repairs.

RELIABLE. HIGH OUTPUT. FORGE AHEAD.

ALL-ROUND PROTECTION. BOMAG REVERSIBLE VIBRATORY PLATES.

These are the ideal models when more compaction output and surface coverage is required. All units in this range feature

effective impact protection and outstanding compaction power.







**LIGHT ALL-ROUNDER:
PERFORMANCE CLASS
25 TO 40 KN.**

With operating weights of 120 to 300 kg and optional transport wheels, these models are easy to transport and are ideal for a very wide range of applications.

MACHINES FOR PROFESSIONALS.

Reversible vibratory plates are popular choices on many small and medium-sized construction sites. BOMAG offers a full range of models with operating weights from 120 to 750 kg. These are uncompromising compaction units for earthworks, asphalt and block paving.

MEDIUM-WEIGHT POWERHOUSES: BPR-PERFORMANCE CLASS 45 TO 60 KN.

The 350 to 500 kg operating weights of these diesel-operated vibratory plates from BOMAG provide excellent compaction results and superb surface coverage, especially on earthworks and paving work.



HEAVYWEIGHT POWER PACK: BPR PERFORMANCE CLASS 70 TO 100 KN.

With large working widths and massive compaction power, these heavyweight models provide top performance on tough sites.



REMOTE CONTROLLED POWERHOUSE: MODEL BPH 80/65 S.

The ultimate compaction power for trench, sewer and pipeline construction. Radio/cable or cable remote control makes work easy and provides an extra level of safety.



THOROUGHLY THOUGHT OUT.

QUICKLY MOVED

Robust, solid rubber transport wheels are quick-mounting, allowing easy movement to the next site. Available on all models up to 300 kg.

GENTLE AND POWERFULL

The city modul allows to adept the frequency and centrifugal forces to the application available with machines > 500 kg (not for US-variant).



EASILY MANOEUVRED

The TipControl and integrated reversing protection as standard provide maximum safety and easy operation in the over 500 kg class. Alternatively, a comfort control lever with low hand-arm vibration values is also available.

FULLY PROTECTED

The hinged, all-round protection hood provides maximum protection and optimum access to the engine and other components, saving time and money.

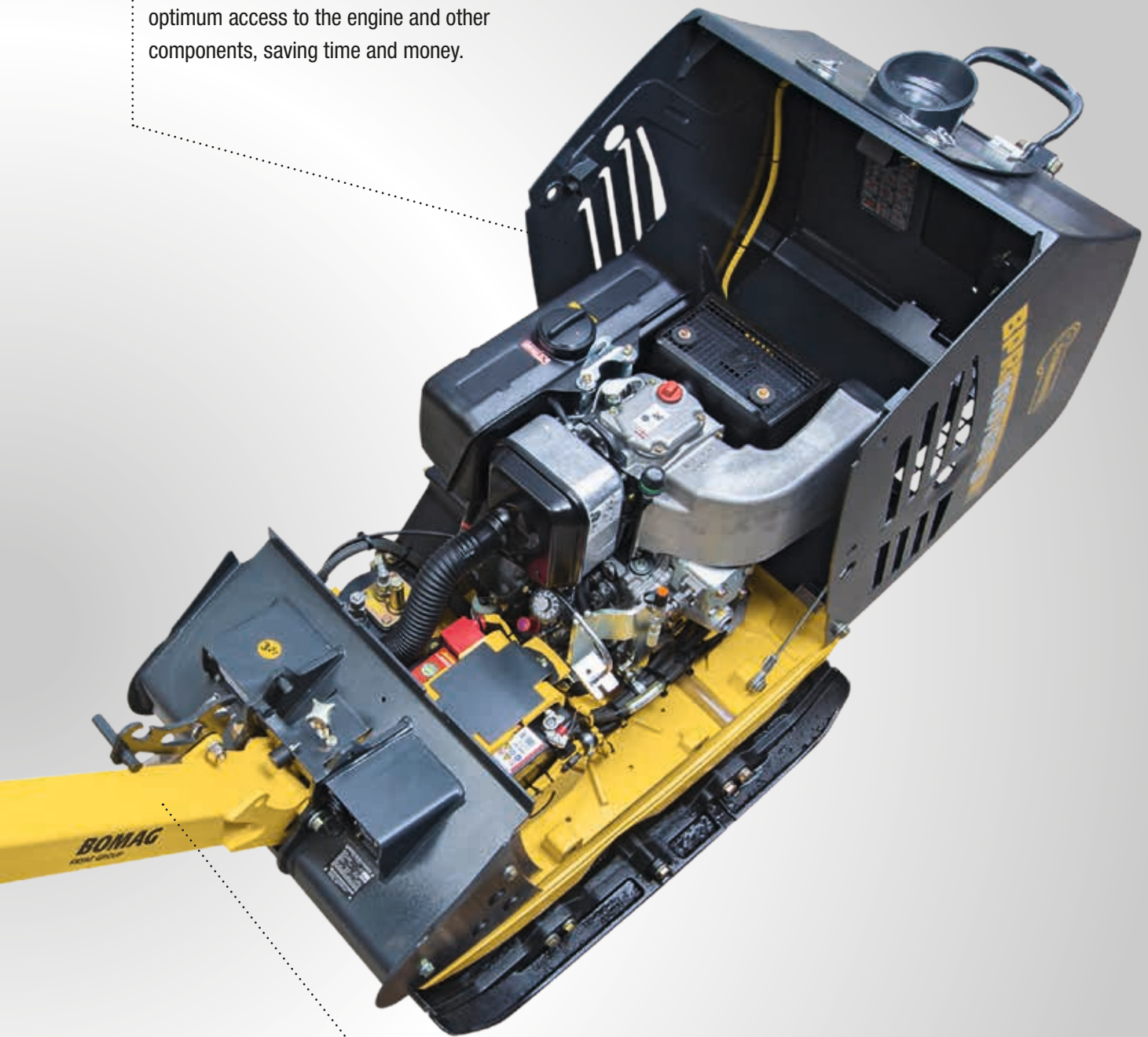

INDIVIDUALLY ADAPTED

Every operator can select the ideal working position with the height adjustable, low-vibration steering rod.

Technical modifications may be required depending on country of distribution.



ECONOMIZER. COMPACTION CONTROL.

The BOMAG ECONOMIZER shows the operator real-time compaction progress on a continuous easy-read display. This support system prevents unnecessary passes

and immediately identifies weak spots. The BOMAG ECONOMIZER is available on all reversible vibratory plates over 350 kg.

STONEGUARD – NOTHING GETS BROKEN HERE.

THE PAVING PLATE.

With conventional compaction equipment, the breakage rate of paving stones is often as high as 30%. Costs can easily escalate. The new BOMAG paving plate is designed to prevent this type of loss. The STONEGUARD series includes several models of reversible vibratory plates with operating weights between 150 and 500 kg. Using this unique paving plate, contractors achieve hitherto unachievable results in terms of sur-

face coverage, handling and quality, with the added bonus of reduced block breakage rates.

BENEFITS:

- Increases working speed by up to 30%
- Prevents edge and paving block breakages
- Allows vibratory compaction to the final block
- Allows vibratory compaction of large slabs
- Prevents damage to surrounding structures



COMPACTION QUALITY. EVERY TIME. EVERY SITE.

THE ORIGINAL – BOMAG HAND-GUIDED ROLLERS.

BOMAG has been the leader in hand-guided rollers since 1957. Beginning with one model, now an entire range of single-

drum and double vibratory rollers that have one thing in common: a better compaction result.





**HEAVY-DUTY DOUBLE
VIBRATORY ROLLER:
MODEL BW 75 H.**

This high-performance wonder is ideal for asphalt construction and earthworks. The 750 mm drum width and the high compaction power of all hand-guided models automatically provides outstanding surface coverage.



**LIGHT DUTY SINGLE
DRUM VIBRATORY ROLLER:
BW 55 E.**

This light all-round model stands out with easy handling in confined spaces. Ideal whenever manoeuvrability and easy transport are key factors. The pioneer in its class.



**HEAVY DUTY SINGLE
DRUM VIBRATORY ROLLER:
BW 71 E-2.**

The BW 71 E-2 excels for surface quality and coverage, especially on asphalt applications and repair and maintenance work. The large 600 mm drum diameter and 710 mm working width give excellent finishing results.



MILESTONES IN COMPACTION TECHNOLOGY.

No other manufacturer has as many years of experience as BOMAG, as this is where it all began with the first hand-guided double vibratory roller. Technology has developed steadily since then. But one thing remains the same: the unrivalled compaction quality and reliability of a BOMAG roller.

LIGHT DOUBLE VIBRATORY ROLLER: MODEL BW 65 H.

This best-selling model features BOMAG double vibration with hydrostatic drive to guarantee smooth speed control and high travel speeds.



THE INNER VALUES ARE WHAT REALLY COUNT.

QUICKLY STOWED

The hinged steering rod offers space-saving transportation and convenient loading.



UNIVERSALLY EMPLOYED

All hand-guided vibratory rollers are equipped with a water tank as standard.

DEPENDABLY POWERED

The maintenance-free, mechanical drive ensures constant traction on any job.

SAFELY OPERATED

From speed control to vibration mode: all functions are easy and safe for the operator to control on one handle.

EASILY STARTED

Manual or electric start comes as standard with these double vibratory rollers.



BURSTING WITH POWER

The proven BOMAG double vibration system produces uniquely quiet and smooth running characteristics giving uniform surface quality. Compaction and surface coverage is outstanding with high centrifugal forces and excellent working speed.

MADE FOR SOIL COMPACTION. WELL-DESIGNED. SAFE.

INTELLIGENT OPERATION. BOMAG MULTI-PURPOSE COMPACTOR.

When work demands high-quality solutions: this articulated, radio-controlled, multi-purpose compactor gets to the places where operators can't go or would

rather not go. With the radio remote control, you have everything safely under control. Including your site.







SUPERIOR COMPACTION.

With an operating weight of around 1.6 t, this multi-purpose compactor achieves outstanding compaction results on soil compaction in trenches, sewers and on pipeline construction.

EARTHWORKS EVOLUTION.

The BOMAG BMP 8500 articulated, multi-purpose compactor was specially designed for earthworks; it is particularly suitable for compaction on cohesive soils in trenches, backfills, sewer and pipeline construction, and sub-structural and foundation work. And anywhere space gets tight or the job gets hazardous.

REMOVABLE DRUM EXTENSION WITH PAD FEET.

The working width can be easily varied between 610 and 850 mm with the drum extensions which come as standard. They are ready for use in any trench in minutes.



ALSO AVAILABLE WITH SMOOTH DRUMS.

The BOMAG BMP 8500 can also be optionally equipped with a smooth drum for improved surface quality without pad footprints, even on sandy materials.



SUPERIOR TECHNOLOGY.

MOST RELIABLE ENGINE

Both the modern KUBOTA engine and BOMAG ECOMODE provide the lowest operating costs. If the remote control is not activated, the engine will automatically change to idle speed after a few seconds. That saves hard cash.



QUICKLY EXTENDED

Reliability from experience: the original BOMAG drum extender allows you to adapt the working width from 610 to 850 mm in just minutes.

RELIABLE RADIO CONTROL

With radio/cable remote control, problems caused by intense sunlight, shoring work, or the simultaneous use of other machines are eliminated. Frequency adjustments and malfunctions due to mechanical wear no longer apply.

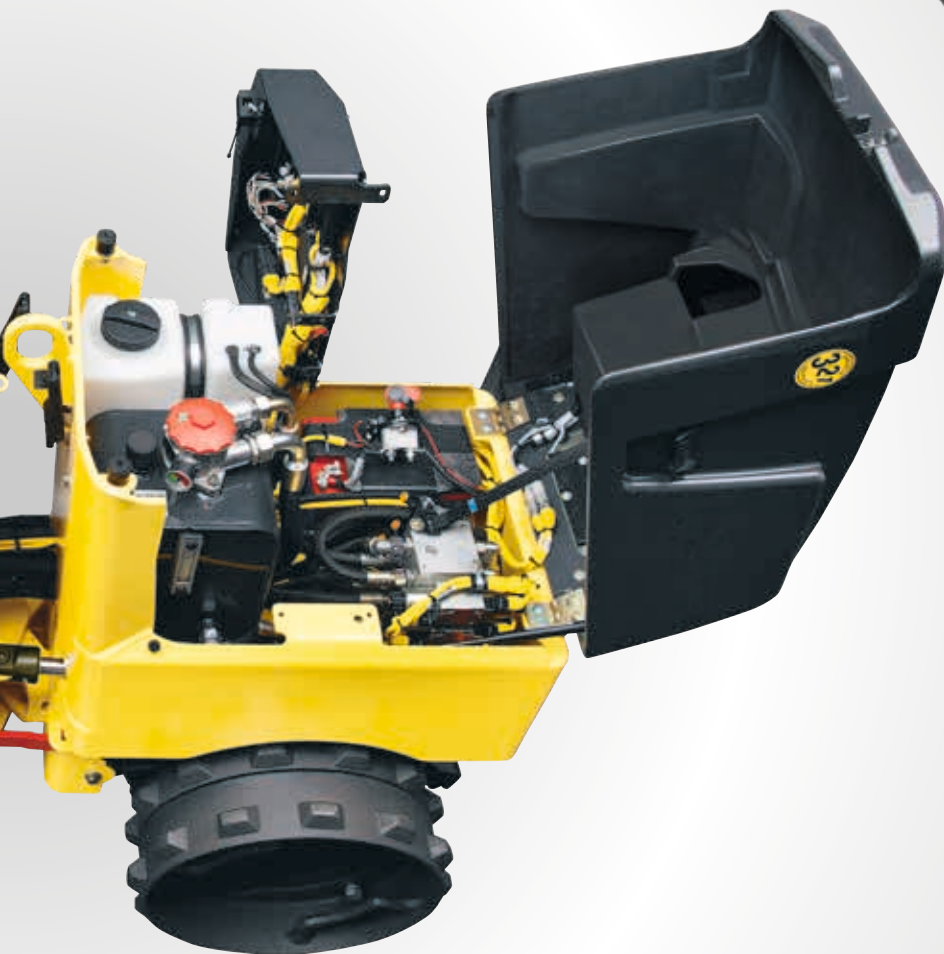

SAFE RESPONSE

If the operator enters into the close vicinity of the machine, the travel system is automatically stopped by BOSS (BOMAG Operator Safety System) to prevent accidents. Nothing could be safer.

BUILT-IN SAFETY

The fully encased exciter housing prevents water and dirt ingress, as well as abrasion to the hydraulic hoses. This increases operational safety and prevents costly repair work over the long term.



Technical modifications may be required depending on the country of distribution.

ECONOMIZER – KNOWING WHEN THE JOB IS DONE.

The BMP 8500 remote-controlled multi-purpose compactor is best used when conditions become confined or inaccessible. Featuring legendary BOMAG quality, this is the first machine of this type to display compaction progress. Guessing is now a thing of the past.

THE OPERATOR KNOWS WHEN COMPACTION IS FINISHED.

Unique in compaction technology: The BOMAG ECONOMIZER is integrated into the hood of the BMP 8500, which means it is easy to see and well protected. The unit aids the operator in achieving optimum compaction results and could not be simpler, as there is no need for activation and calibration.

The ECONOMIZER automatically determines compaction progress. This allows the operator to identify weak spots in the subsoil continuously and accurately, and to respond appropriately in good time. Expensive reworking is no longer necessary. In addition, unnecessary passes and overcompaction are also avoided which results in time savings of up to 25%.



EARTHWORKS REVOLUTION.

The first remote-controlled, multi-purpose compactor that knows when it's finished. With ECONOMIZER, the operator knows when optimum compaction has been achieved.



ALWAYS THE RIGHT CHOICE: BOMAG GENUINE PARTS AND SERVICE.

You deliberately opted for a BOMAG when deciding on your machine. To ensure the long-term performance of your equipment, you can also rely on the tried and trusted quality of BOMAG's service and genuine parts.



GUARANTEED BOMAG QUALITY.

If you work a site hard, you need to be able to rely on your machines. This is why every BOMAG machine is tested thoroughly, inside and out. We have total confidence in the quality of our machines, which is why we offer the 3-2-1 warranty as standard.



ALL SERVICE PARTS IN ONE BOX.

BOMAG Service Kits are individually compiled by our service experts for your BOMAG machine and contain all the parts required for professional maintenance in one handy package. This not only saves you time, but money - up to 15% compared to individual orders.

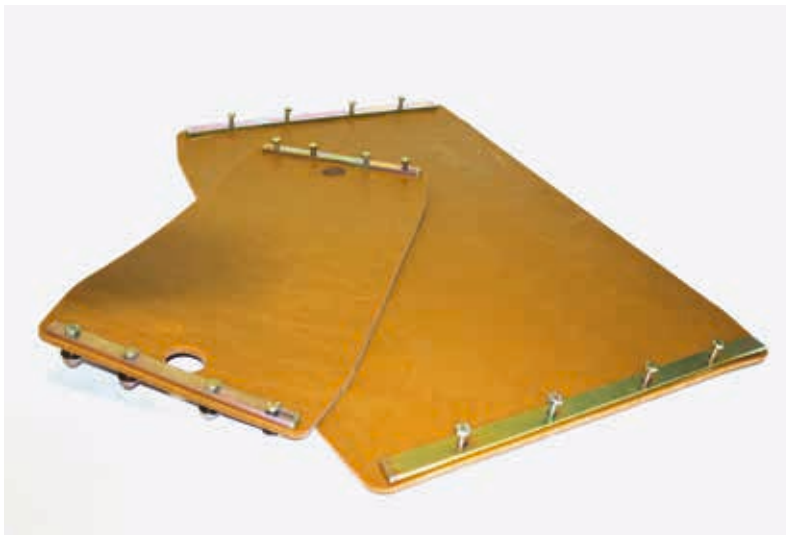

UNIQUELY BOMAG.

BOMAG genuine parts are matched exactly to your machine, and offer reliability and proven quality. Unlike copies, they meet our highest quality standards in terms of functionality and service life so that your BOMAG remains a BOMAG.



ALWAYS RELIABLE.

The best service and high availability of genuine parts are included when you purchase your BOMAG. With twelve foreign subsidiaries and over 500 dealers in more than 120 countries, you can count on us as a reliable partner worldwide. No matter where your machine is in operation, we will never let you down!

APPLICATION TIPS FOR EARTHWORKS AND ASPHALT.

Guidelines* for the non-compacted/compacted layer thickness dependant on soil type and type of compaction equipment.



		kN	kg	Rock
BT 60		≤15	< 62	–
BT 65		16-17	62-85	–
B(V)P 10/xx - BVP 18/45		<20	47-91	–
BP 20/50 (D)		≥20	95-109	–
BP 25/50 (D)		≥25	108-122	–
BPR 25/xx		≤25	≤150	–
BPR 35/xx		≤35	≤230	–
BPR 45/55 D, BPR 50/55 D		≤50	≤400	–
BPR 55/65 D, BPR 60/65 D		≤60	≤460	–
BPR 70/70 D		≤70	≤600	35 → 40
BPR 100/80 D, BPH 80/65 S		≤100	>700	50 → 45
BW 55 E		10	≤170	–
BW 71 E-2		16	≤530	–
BW 65 H		22	≤800	–
BW 75 H		40	≤1100	–
BMP 8500		72	≤1500	–



		kN	kg	2 - 4 cm
BT 60, BT 65		14-17	55-85	–
B(V)P 10/35 - BP 20/50		10-20	47-109	✓
BP 25/50 - BP 25/50 D		<25	>108	✓
BPR 25/XX		≤25	<150	✓
BPR 35/XX		≤35	<300	–
BPR 45/55 D - BPR 70/70 D		45-70	390-600	–
BW 55 E		10-16	150-500	✓
BW 71 E-2		10-16	150-500	✓
BW 65 H, BW 75 H		22-40	650-1100	✓

*These guidelines are the result of trial compaction and site operations. Compaction specifications can generally be achieved in four to eight passes under normal application conditions.

Crushed stones	Gravel / Sand	Mixed soil	Silt / Clay
30 → 25 30 → 25	45 → 35 50 → 40	35 → 30 35 → 30	30 → 25 30 → 25
- - 15 → 13	25 → 20 30 → 25 35 → 30	20 → 15 25 → 20 30 → 25	- - 20 → 15
35 → 30 35 → 30 42 → 35 50 → 40 55 → 45 75 → 60	30 → 25 30 → 25 35 → 30 45 → 35 50 → 40 60 → 50	30 → 25 30 → 25 35 → 30 45 → 35 50 → 40 60 → 50	20 → 15 20 → 15 30 → 25 30 → 25 35 → 30 40 → 35
- -	25 → 20 25 → 20	25 → 20 25 → 20	- 18 → 15
13 → 10 13 → 10	25 → 20 30 → 25	25 → 20 30 → 25	12 → 10 18 → 15
35 → 30	40 → 35	40 → 35	35 → 30







	6 - 8 cm	10 - 14 cm
	✓	✓
	- ✓ (6 cm)	- ✓ (10 cm)
	✓ ✓ -	✓ (10 cm) ✓ ✓
	✓ ✓	- ✓
	✓	✓



- unsuitable ✓ suitable

APPLICATION TIPS FOR PAVING WORK.

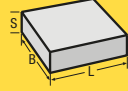
Guidelines* for the non-compacted/compacted layer thickness depending on soil type and compaction equipment.

	Plastic mats 	kN	kg				STONEGUARD 	
				6	cm: 8-10	> 12		
	<ul style="list-style-type: none"> ■ Natural stone (smooth or rough) ■ Concrete blocks and plates ■ Small to medium-sized surfaces 	B(V)P 10/XX - BP 12/40	≤12	47-83	✓	–	–	<ul style="list-style-type: none"> ■ Concrete blocks ■ Smooth natural stone ■ Large surfaces ■ Non bevelled stones ■ Sensitive surfaces
		B(V)P 18/45 - BP 25/50	>15	83-125	✓	–	–	
		BPR 25/XX	≤25	≤150	✓	✓	–	
		BPR 35/XX - BPR 40/60 D	≤35	≤230	✓	✓	–	
		BPR 45/55 D - BPR 60/65 D BPR 70/70 D	≤60 >65	≤460 >550	– –	✓ ✓	✓ ✓	

*These guidelines are the result of trial compaction and site operations. Compaction specifications can generally be achieved in four to eight passes under normal application conditions.

- The guide values come from trial compaction and one-site operations. The specified compaction can be achieved in four to eight passes, under normal application conditions.

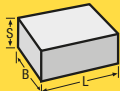
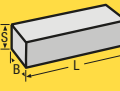
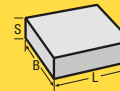
						
					$L \gg B$	
	kN	kg	6 cm	8 cm	10 cm	> 10 cm
BPR 25/50	≤ 25	≤ 150	✓	✓	–	–
BPR 35/60	≤ 35	≤ 230	✓	✓	✓	–
BPR 35/60 D						
BPR 50/55 D	≤ 60	≤ 460	–	✓ ⁽¹⁾	✓	✓
BPR 50/65 D						
BPR 60/65 D						



– unsuitable

✓ suitable

- Please observe the laying instructions of the paving stone manufacturer.
- BOMAG GmbH recommends creating trial areas because the different concrete blocks cannot be generalised.

THE RIGHT MACHINE FOR EVERY JOB.

TAMPER



BT 60
Operating weight: 58 kg
Centrifugal force: 15 kN
Working width: 230 mm



BT 65
Operating weight: 68 kg
Centrifugal force: 17 kN
Working width: 280 mm



BVT 65
Operating weight: 67 kg
Centrifugal force: 16 kN
Working width: 280 mm
available in EU + CH + NA



BT 80 D
Operating weight: 81 kg
Centrifugal force: 17,5 kN
Working width: 330 mm
not available in US + CN + IN



BT 60 G
Operating weight: 65 kg
Centrifugal force: 15 kN
Working width: 230 mm
available in DE



BT 65 G
Operating weight: 75 kg
Centrifugal force: 17 kN
Working width: 280 mm
available in DE



BVP 10/30
Operating weight: 47 kg
Centrifugal force: 10 kN
Working width: 300 mm



BVP 10/36
Operating weight: 83 kg
Centrifugal force: 10 kN
Working width: 360 mm



BVP 12/50 A
Operating weight: 72 kg
Centrifugal force: 10 kN
Working width: 300 mm



BVP 18/45
Operating weight: 91 kg
Centrifugal force: 18 kN
Working width: 450 mm



BVP 18/45 D
Operating weight: 109 kg
Centrifugal force: 18 kN
Working width: 450 mm



BPS 18/45
Operating weight: 91 kg
Centrifugal force: 18 kN
Working width: 450 mm
available in CN



BPR 35/60
Operating weight: 205 kg
Centrifugal force: 35 kN
Working width: 600 mm



BPR 35/60 D
Operating weight: 225 kg
Centrifugal force: 35 kN
Working width: 600 mm



BPR 40/60 D
Operating weight: 260 kg
Centrifugal force: 40 kN
Working width: 600 mm



BPR 45/55 D
Operating weight: 400 kg
Centrifugal force: 45 kN
Working width: 550 mm



BPR 50/55 D
Operating weight: 485 kg
Centrifugal force: 50 kN
Working width: 550 mm

STONEGUARD



STONEGUARD
Working width: from 530 to 680 mm
available for BPR 25/50 D, BPR35/60
BPR 35/60 D, BPR 50/55 D
BPR 55/65 D, BPR 60/65 D

Reversible Hydraulic Plate



BPH 80/65 S
Operating weight: 750 kg
Centrifugal force: 80 kN
Working width: 800 mm

Hand-guided Single Drum Vibratory Rollers



BW 55 E
Operating weight: 150 kg
Centrifugal force: 10 kN
Working width: 560 mm



BW 71 E-2
Operating weight: 485 kg
Centrifugal force: 16 kN
Working width: 710 mm

Single Direction Vibratory Plates



<p>BP 10/35 <i>Operating weight: 65 kg Centrifugal force: 10 kN Working width: 350 mm</i></p>	<p>BP 12/40 <i>Operating weight: 72 kg Centrifugal force: 12 kN Working width: 400 mm</i></p>	<p>BP 12/50 A <i>Operating weight: 82 kg Centrifugal force: 12 kN Working width: 500 mm</i></p>	<p>BP 20/50 <i>Operating weight: 95 kg Centrifugal force: 20 kN Working width: 500 mm</i></p>	<p>BP 20/50 D <i>Operating weight: 109 kg Centrifugal force: 20 kN Working width: 500 mm</i></p>	<p>BP 25/50 <i>Operating weight: 108 kg Centrifugal force: 25 kN Working width: 500 mm</i></p>	<p>BP 25/50 D <i>Operating weight: 122 kg Centrifugal force: 25 kN Working width: 500 mm</i></p>
---	---	---	---	--	--	--

Reversible Vibratory Plates



<p>BPR 25/40 <i>Operating weight: 135 kg Centrifugal force: 25 kN Working width: 400 mm</i></p>	<p>BPR 25/40 D <i>Operating weight: 150 kg Centrifugal force: 25 kN Working width: 400 mm</i></p>	<p>BPR 25/50 <i>Operating weight: 140 kg Centrifugal force: 25 kN Working width: 500 mm</i></p>	<p>BPR 25/50 D <i>Operating weight: 155 kg Centrifugal force: 25 kN Working width: 500 mm</i></p>	<p>BPR 35/42 D <i>Operating weight: 210 kg Centrifugal force: 35 kN Working width: 420 mm</i></p>
---	---	---	---	---



<p>BPR 55/65 D <i>Operating weight: 455 kg Centrifugal force: 55 kN Working width: 650 mm</i></p>	<p>BPR 60/65 <i>Operating weight: 400 kg Centrifugal force: 60 kN Working width: 650 mm</i></p>	<p>BPR 60/65 D <i>Operating weight: 460 kg Centrifugal force: 60 kN Working width: 650 mm</i></p>	<p>BPR 70/70 D <i>Operating weight: 580 kg Centrifugal force: 70 kN Working width: 700 mm</i></p>	<p>BPR 100/80 D <i>Operating weight: 710 kg Centrifugal force: 100 kN Working width: 800 mm</i></p>
---	---	---	---	---

Hand-guided Double Drum Vibratory Rollers



<p>BW 65 H <i>Operating weight: 757 kg Centrifugal force: 22 kN Working width: 650 mm</i></p>	<p>BW 75 H <i>Operating weight: 1,040 kg Centrifugal force: 40 kN Working width: 750 mm not available in US + CN + IN</i></p>
---	---

Multipurpose Compactor



BMP 8500
*Operating weight: 1,595 kg
 Centrifugal force: 72/36 kN
 Working width: 610 mm / 850 mm*





**IN EVERY MACHINE.
COMPACT KNOW-HOW FROM OUR
SHARED WEALTH OF EXPERIENCE.**

From tampers to multi-purpose compactors: our almost 60 years of compaction experience flows into every machine. As does our understanding of your needs,

because every conversation we have with you makes us wiser and our machines better. Thank you for your confidence in BOMAG!