



# *SCX 2800A-3*



# Further, Higher. New 275 t.

Building a better society for all, helping to make tomorrow brighter. To achieve such objectives, HSC embarked on development of the 275 t class crawler crane by endowing it with performance to meet a new day and age. Power and precision were of course elements deemed essential for reliable work, but HSC went above and beyond to incorporate additional features: better assembly to boost work efficiency; pioneering fuel efficiency and eco-friendly design; and safety and comfort for both crane operators and site operations.

The new SCX2800A-3 delivers a superior level of performance in a more user-friendly package – all for building a better tomorrow. And with time-tested quality and sophisticated capability, the new SCX2800A-3 is all about reaching for higher goals around the world.

## SCX 2800A-3



**GOOD  
DESIGN**

The Good Design Award has been granted to the "SCX-3 Series" for its superb operability, ease of transportation and assembly, safety, and eco-friendly performance as a new generation of crane.



## SCX2800A-3 PERFORMANCE

### High-performance 275 t lifting capacity to boost work sites.

The high-performance 275 t lifting capacity is ideal for building tomorrow. In addition to a powerful winch for steady operations, Eco winch mode also allows for streamlined operations and energy efficiency. Designed with a revolutionary approach for easier operation as well as the availability of wide shoes and reduction counter weight specifications, the SCX2800A-3 is built to meet an increasingly diverse range of job sites.



#### Max. lifting capacity

Liftcrane : 275 t x 4.3 m

Luffing towercrane : 80 t x 9.3 m

#### Swing neutral brake standardization



During work requiring the cab to swing (when the swing lever is in the neutral position), the operator may choose between free or brake mode depending on the work and personal preferences, making operations so much smoother.

Swing mode selector switch

#### Powerful winch

Equipped with a 13.5 t rated line pull winch for quick and powerful hoisting as well as ample performance for more complex operations. A wide winch drum design minimizes damage to winch ropes.

**Simple operation**  
ECO winch mode is activated automatically using the ordinary control levers if the ECO winch switch is ON and certain operating conditions are met (hook only, 1150 rpm or lower engine speed).

#### Eco winch mode with high-speed winching and low-fuel consumption

Also included is a new Eco winch mode, which allows high line speeds under light loads without having to increase the engine speed (low rpm). This mode delivers outstanding workability in situations such as high-elevation construction sites and multiple rope hanging operations and also limits fuel consumption and noise as engine speed can be kept at a minimum.

#### Reduction counter weight specification **OPTION**

Reduction counter weight specification are available as an optional extra to provide added flexibility for a diverse range of worksites, including high locations and within tight internal areas where operating weight is limited or restricted (with counter weight detector).

Counter weight				
	Std	-1 layer	-2 layers	-3 layers
Total operating weight	231 t (233 t)	208 t (210 t)	173 t (175 t)	156 t (158 t)
Ground contact pressure	129 kPa (115 kPa)	116 kPa (104 kPa)	96.4 kPa (86.4 kPa)	87.0 kPa (78.0 kPa)

Note: Figures in ( ) are when wide shoes (option) are installed.  
Reduction counter weight specifications are configured to suit crane specifications excluding the crane jib.

#### Wide 1,260 mm shoes **OPTION**

Wide shoes are available as an option that are 140 mm wider than the standard shoes. These help to reduce ground contact pressure (by approx. 8%) to suit a broader range of work types.



## SCX2800A-3 CONTROL

### Full command of precision control. Superior operations mean greater peace of mind.

The superior operating comfort of the advanced control system mean smooth movement exactly as intended, with an exceptionally sharp level of control.

The result is unprecedented sophistication for lifting and moving, which are the essential requirements of cranes.



#### Tilt cab for better operator visibility

The SCX2800A-3 comes with a cab tilt mechanism that allows the cab to tilt back up to 18° to make moving loads at heights easier. The optimum work position suited to the job ensures the best possible operator visibility.

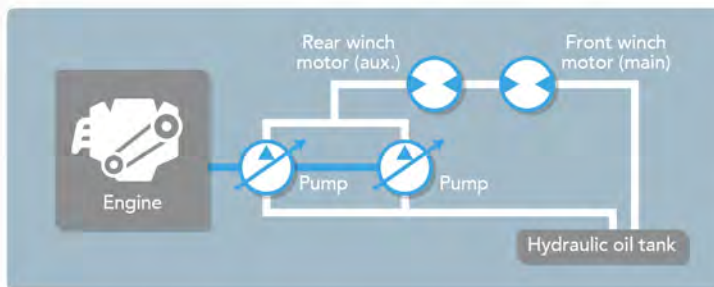

#### Combined hydraulic circuits

The hydraulic system uses HSC's own unique combined hydraulic circuit. By increasing and optimizing the pump pressure through the use of a mixed circuit to control the hydraulic oil from two hydraulic pumps, the sense of operability in traveling, hoisting/lowering, swing and boom hoisting can be enhanced. Even for multiplex operations, the latest hydraulic control system is able to support all tasks efficiently through priority control that match operating requirements. This helps to achieve a sense of operability that matches the intent of the operator.



#### Control dials

Fine speed control dials for operations such as hoisting, lowering, swinging and boom hoisting are positioned in a central location on the left side console. Operations can be adjusted at will to suit the particular job.



Left: Boom hoist operation pedal  
Right: Swing brake operation pedal

#### Swing brake operation pedal **OPTION**

A swing brake operation pedal is available to ensure precise swing control under strong-wind situations. This allows brake control to be applied when swinging the cab around, resulting in precise swing control even on the harshest of worksites.

## SCX2800A-3 SAFETY

### Reliable and precise. Advanced safety features for the unexpected.

Improving safety should come first and foremost. A simple, easy-to-view interface has been designed to ensure that information is provided to the operator in the most reliable way possible. Various accident prevention functions and multiple redundant safety devices have also been installed for protection against the unexpected. Work is covered by the utmost safety and reliability with a full complement of advanced safety equipment.

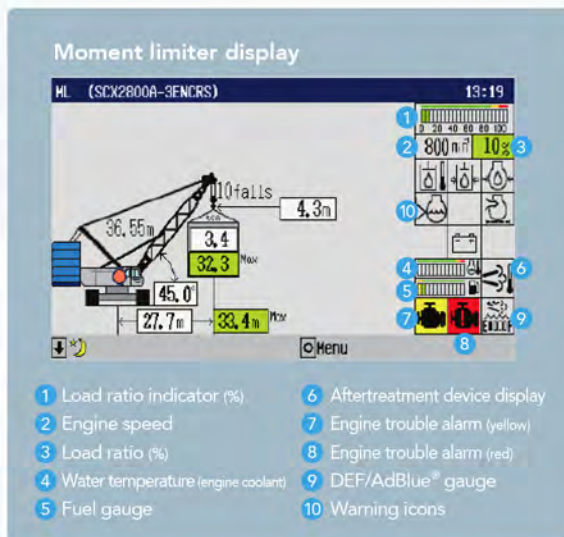

#### Moment limiter with large screen display

A large screen display has been used offering excellent visibility and field of view of any job. A host of items can be shown, while a simple display layout ensures that information is provided to the operator properly. The display has also been designed with an interactive interface to follow any movement of the crane from a safety perspective, which helps to limit unintended operations and maintain utmost safety.

#### ML Anti-two block

A new anti-two block using a lifting height indication device is offered as a standard equipment. When a height restriction is set in advance in the lifting height meter, the slowdown function will kick in as the restricted height is approached to prevent hook overhoist. Together with the anti-two block switch, the lifting height moment limiter provides a redundant level of safety against hook overhoist, leading to improved safety.

Note) This function plays a supplementary role to the existing moment limiter and use of this equipment alone is prohibited by laws and regulations.







### Swing restriction unit **OPTION**

The swing restriction unit prevents the crane from swinging into objects by allowing the swing range to be preset, and notifying the operator of the swing range and automatically stopping the crane when required. Together with the restricted swing range function, the result is an added level of safety when working in tight areas.



Rear view monitor camera

### Drum and rear monitoring camera **OPTION**

An optional drum and rear monitoring camera is useful for keeping an eye on winch conditions.

The switchable camera view makes it easy to monitor the movement of each section (6 areas) of the crane. The camera also has a magnetic mount so that it can be relocated for better visuals to suit any working environment.

### Designed for safe operation

The auto drum lock function is equipped as standard, to detect when the boom is being controlled and automatically lock the drum when the lever is in the neutral position. Various warnings and alerts when driving and swinging notify the operator and others nearby to minimize accidents caused by carelessness. A boom speed slowdown function is also included.



### Catwalk **OPTION**

The catwalk with handrail (option) useful during work features wider steps designed to make operations safer. Catwalk access points have been increased from three to six locations to make it easier to get to the machinery cab and engine house. The catwalks can be retracted for transportation.

#### Other safety functions and devices

- Three color percentage indicator **OPTION**
- Independent winch operation lever locks
- Winch drum lock (front/rear)
- Handrail (removable) **OPTION**
- Gate lock lever
- Auto slowdown device
- Engine emergency stop switch
- Anti-two block
- Travel pedal lock

## Enhanced visibility and smooth operations for greater comfort peace of mind.

Designed to make the stressful job of operators, more stress-free and more comfortable. Excellent visibility is just the start, and with easy-to-use accessories and an ergonomic control layout, the SCX2800A-3 is designed to make things smooth. These all help to reduce operator fatigue, while at the same time increasing comfort and functionality for maximum performance, day-in, day-out.



Photos may differ to the specifications of available products.

### Better visibility in all directions

The cab has extra-wide windows to improve visibility in all directions. Green tinted safety glass has been used all round to protect the operator from UV rays and objects that may have come free during operation. The wipers now sweep a greater area to make work easier, even when working in rain.

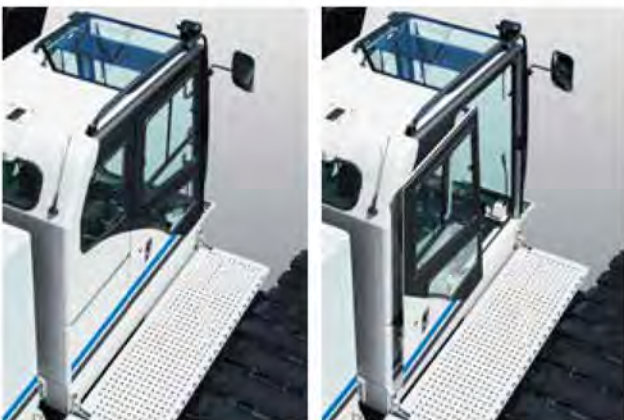

### New large sliding door

A sliding door and wide platform have been implemented to reduce the amount of space required when opening and closing the door, which makes getting in and out of the cab a breeze. Three steps on the side of the crawler side frame have been used for even better access.

### Various items for more comfortable work



Cross operation lever **OPTION**



Wipers with greater sweep area



Sunshade



Cab roof window guard **OPTION**

The photo is a different color to the standard color (black).



**Highly-functional seat for optimum work position**

The new seats are designed with the ideal shape for a more comfortable seating position. The wide range of seat adjustments means it suits any body shape, for the best work and a relaxing posture. A seat with suspension is available as an optional extra.

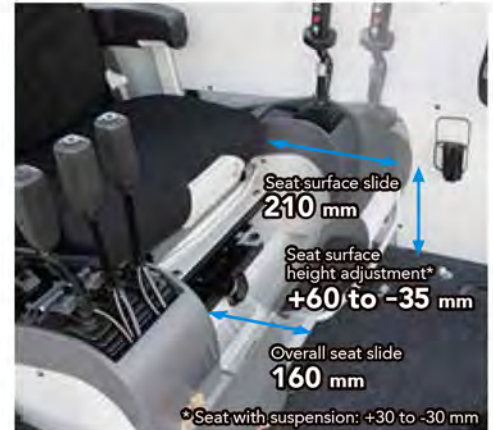

Wide range of seat adjustments



Full-flat design for resting



**Control levers with drum rotation sensor**

Control levers are designed for better operation with optimization made to the pitch, and a winch drum rotation sensor is also included. Any rotation in the winch is conveyed to the operator via the levers, for full control required for precision hoisting jobs. The result is smooth winching where accuracy is vital, such as positioning bolts with the crane.



**Upper cabin controller**

Controllers for the wipers, work lights, drum lock and other functions have been installed higher up near frequently used controls for a more natural layout.

**Useful and functional interior accessories**



Outside-air intake air-conditioner



Cup holder



AM/FM radio (with clock)



Storage shelf

## SCX2800A-3 TRANSPORTABILITY

### Superior transportation and assembly for advanced efficiency.

Designed to suit a diverse range of worksites and contemporary job needs, with outstanding crane performance and streamlined transportation and assembly. Complementing the enhanced self-assembly function is a setup process designed to reduce assembly time and maintain safe operations, giving worksites an unrivaled level of efficiency.



#### Counter weight self-assembly unit **OPTION**

An optional counter weight self-assembly unit is available to make self-assembly easier and to make the assembly process more efficient. The removable frame can be secured safely from ground level, and the number of counter weight fixing points on the crane has been reduced to further assist assembly.

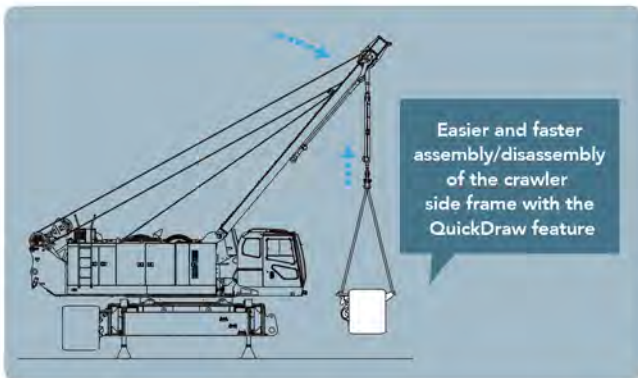

#### QuickDraw **OPTION**

QuickDraw is available for self-installation/removal of the heavy crawler side frame, lower weight, counter weight (including base weight), lower boom allowing assembly by smaller helper cranes. Other assembly procedures can be conducted at the same time, which further increases assembly efficiency.

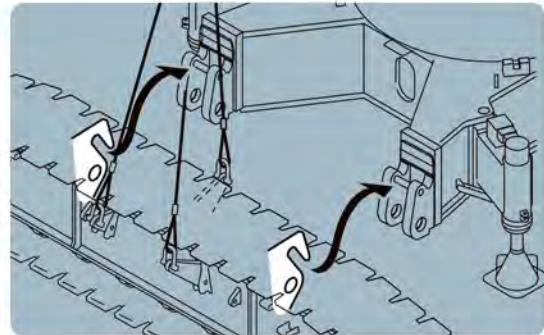

#### Hook-on and pin joint crawler side frame

A removable crawler mounting system has been used, which when combined with the simple removable cylinder mechanism makes assembly and disassembly easier, and also ensures safe operations during assembly.

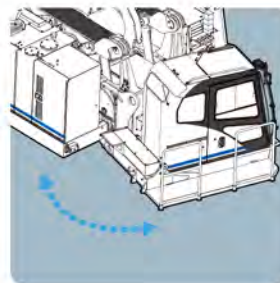

#### Swing cab mechanism

A swing cab mechanism has been incorporated as standard to achieve superior crane performance and transportability, allowing operators to switch quickly and easily back to the operating position.



#### Extension boom with hanging lugs

The extension boom features hanging hooks designed to enhance assembly. The extension boom makes checking weight balance and other procedures easier, resulting in quicker assembly (crane boom only).

#### Other improvements to assembly

- Multi-assembly stage monitoring system
- Easier joint pin insertion/removal

## REMOTE SENSING

### “REMOTE SENSING” system installed as standard

Precise monitoring of the crane’s operating condition to minimize downtime and ensure accurate maintenance. Keeping machines in the best possible operating condition helps to improve operating efficiency, while also reducing the time and cost required for maintenance.

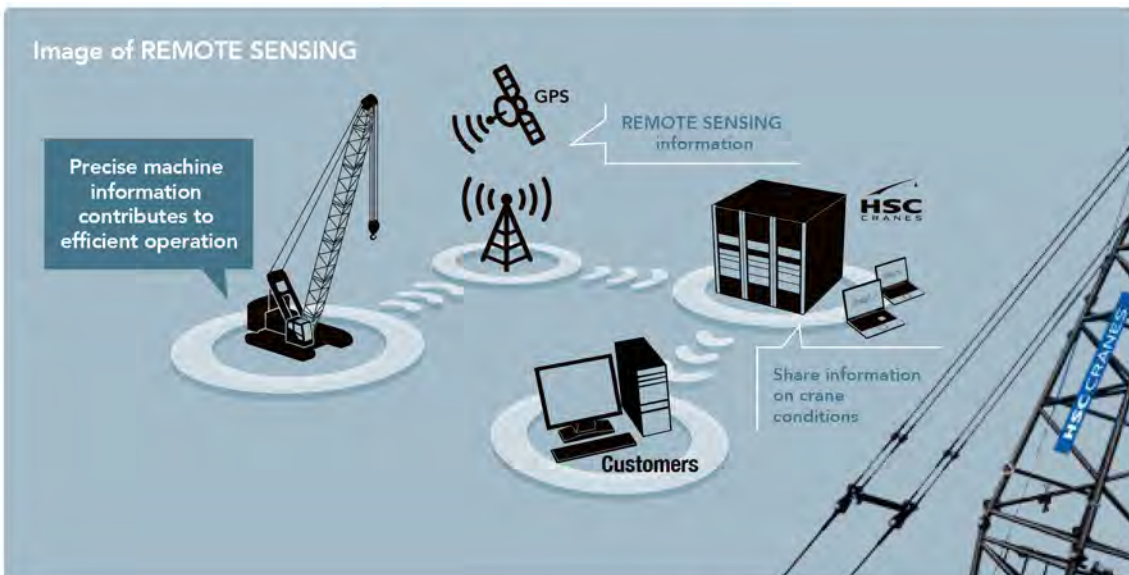

\* Photos may differ to the specifications of available products.

■ General dimensions

Units: mm

Figures in ( ) are when wide shoes (option) are installed.

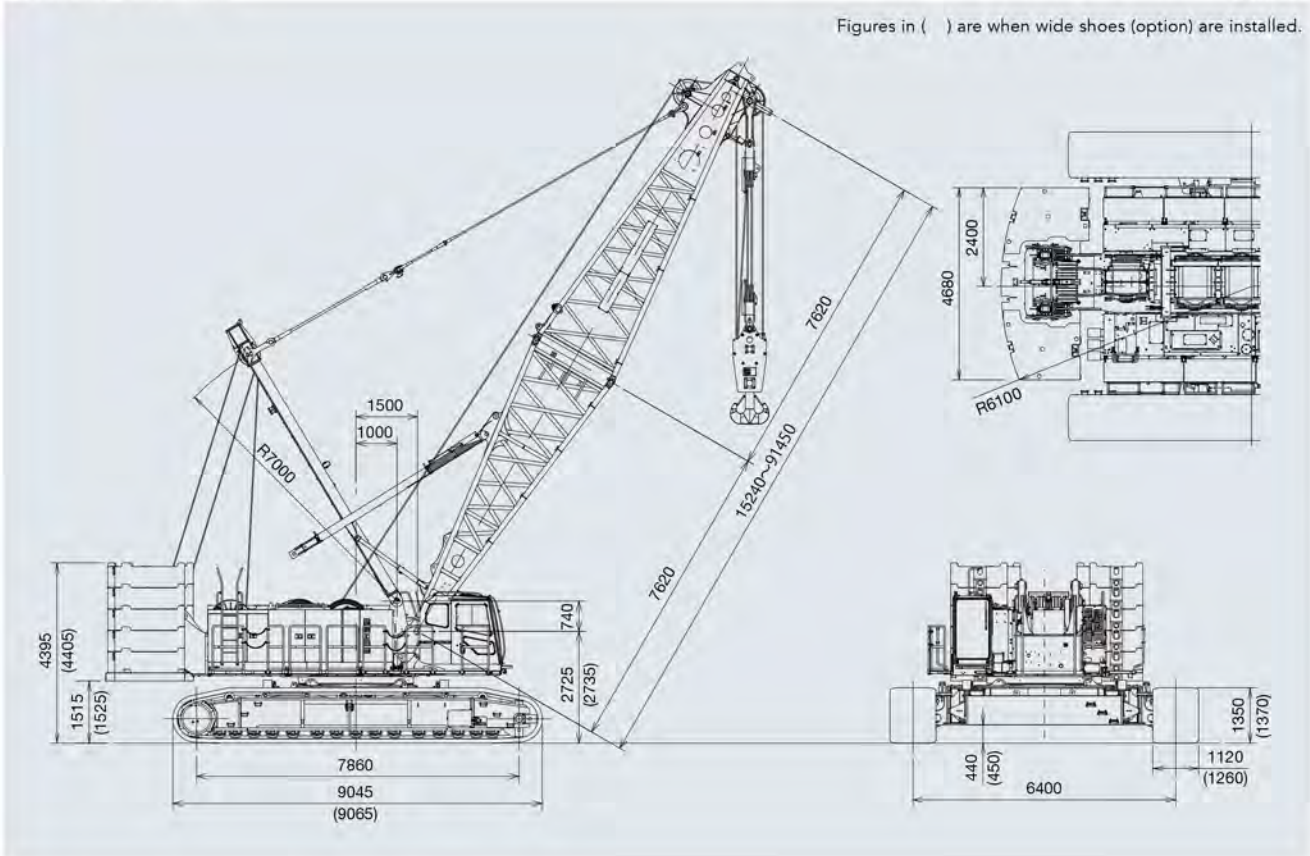

■ Specifications

Model		SCX2800A-3	
Application		Liftcrane	Luffing towercrane
Max. lifting capacity	t × m	275 × 4.3	80 × 9.3
Basic boom length	m	15.25	—
Max. boom length	m	91.45	—
Crane jib length	m	12.20 ~ 36.55	—
Max. boom + crane jib length	m	70.10 + 36.55	—
Tower length	m	—	21.35 ~ 60.95
Tower jib length	m	—	21.35 ~ 60.95
Tower + jib length	m	—	60.95 + 60.95
Rope line speeds (*1)	Front/rear main drum	m/min	110 ~ 2
	Boom hoist drum	m/min	30 × 2
	Tower jib hoist drum (Optional)	m/min	55
Swing speed	min <sup>-1</sup> (rpm)	1.5	1.5
Travel speed high/low (*2)	km/h	1.0 / 0.5	1.0 / 0.5
Gradeability	% (°)	30 (17)	30 (17)
Engine	Make & model	Cummins QSL9 (Stage IV / Tier 4 f)	
	Rated output	kW/min <sup>-1</sup> (PS/rpm)	272/2,000 (370/2,000)
Ground contact pressure	kPa (kgf/cm <sup>2</sup> )	129.0	141.8
Operating weight	t	231	255
		With 15.25 m boom and 275 t hook	With 60.95 m tower, 60.95 m tower jib and 80 t hook block

Notes: 1. Rope line speeds vary under load and operating conditions (\*1). 2. Travel speed is based on flat, level and firm supporting surface with no load and 15.25 m basic boom (\*2).

- We are constantly improving our products and therefore reserve the right to change designs and specifications without notice.
- Units in this catalog are shown under International System of Units (SI). The figures in parenthesis are under the older British Gravitational System of Units.
- Illustrations may include optional equipment and accessories, and may not include all standard equipment.
- Standard equipment and accessories may vary by country and region.

Sumitomo Heavy Industries Construction Cranes Co., Ltd. has been abbreviated as "HSC" throughout this catalog. "HSC CRANES" is a brand of Sumitomo Heavy Industries Construction Cranes Co., Ltd.