

SPECIFICATION



 120t

 66m

 60m

 91m

SAC1200E

SANY ALL TERRAIN CRANE

QUALITY CHANGES THE WORLD

crane.sanyglobal.com

It is one of the core business units in SANY Group, specializing in the development and manufacturing of high-end wheel cranes, crawler cranes and tower cranes, including the complete range of wheel cranes from 8 to 1800t, crawler cranes from 25 to 4500t and tower cranes from 6 to 185t.

三一集团旗下核心事业部，从事高端轮式起重机、履带起重机、塔式起重机系列产品的研发制造。覆盖8-1800吨全吨位轮式起重机，25-4500吨全吨位履带起重机，6-185吨塔式起重机。



SANY CRANE



SAC1200E

SANY ALL TERRAIN CRANE
120T LIFTING CAPACITY

SAC1200E is an all-terrain crane with 120t lifting capacity, 7 section 66m boom, and features dual engine power system, 940mm counterweight position adjustment, wireless remote control of all motions, optional anti-electromagnetic interference module, and the brand-new iCab, with driving and operation comfort fully upgraded.

一款最大起重量120吨、7节臂、最大臂长66米的全地面起重机，双发动力系统，配重可变位940mm。全部作业动作可以实现无线遥控，可选装抗电磁干扰模块，配备全新上下驾驶室——iCab，驾驶、操作舒适度全面升级。



66m boom

Boom full extension 66m

66m主臂

主臂全伸最长66m

Wireless remote control

Wireless remote control available for all actions

无线遥控

整车动作全部实现无线遥控



Anti-electromagnetic interference

An anti-electromagnetic interference module adopted, enabling well functioning under strong electric and magnetic conditions (excluding wireless operations)

抗电磁干扰

通过抗电磁干扰模块可以实现在强电强磁下的正常工作（不含无线操作）

Brand new iCab design

Ergonomic concept of safety and comfort

全新操纵室

操作安全、舒适、人机工程全面升级



i-Cab - Driver's Cab

新两室 - 驾驶室

Multi-function seat with air suspension, making driving more comfortable.

Double seats and foldable berth for the co-driver.

10.1-inch touch screen integrated with back-up image and multi-media.

Electric rearview mirror with electric heating, ensuring good field of view in foul weather.

Adjustable high-brightness LED headlamps/fog lamps, providing clear vision at night.

Reversing sensor with accurate distance detection capability, fully covering the parking area without blind spots, and effectively avoiding scratch and collision.

Full-automatic HVAC, able to automatically adjust indoor temperature as demanded.

主驾驶位配备气浮多功能座椅，驾驶更舒适。

副驾驶位设置双座椅可折叠式卧铺。

10.1英寸触摸大显示屏，集成倒车影像、语音娱乐功能。

电动、电加热后视镜，不惧怕恶劣冰雪天气。

高亮度可调节LED大灯/雾灯，提供夜间清晰视野。

倒车雷达，探头后方无死角，精准探距，防碰防撞。

全自动冷暖空调，自动根据需求调整室内温度。

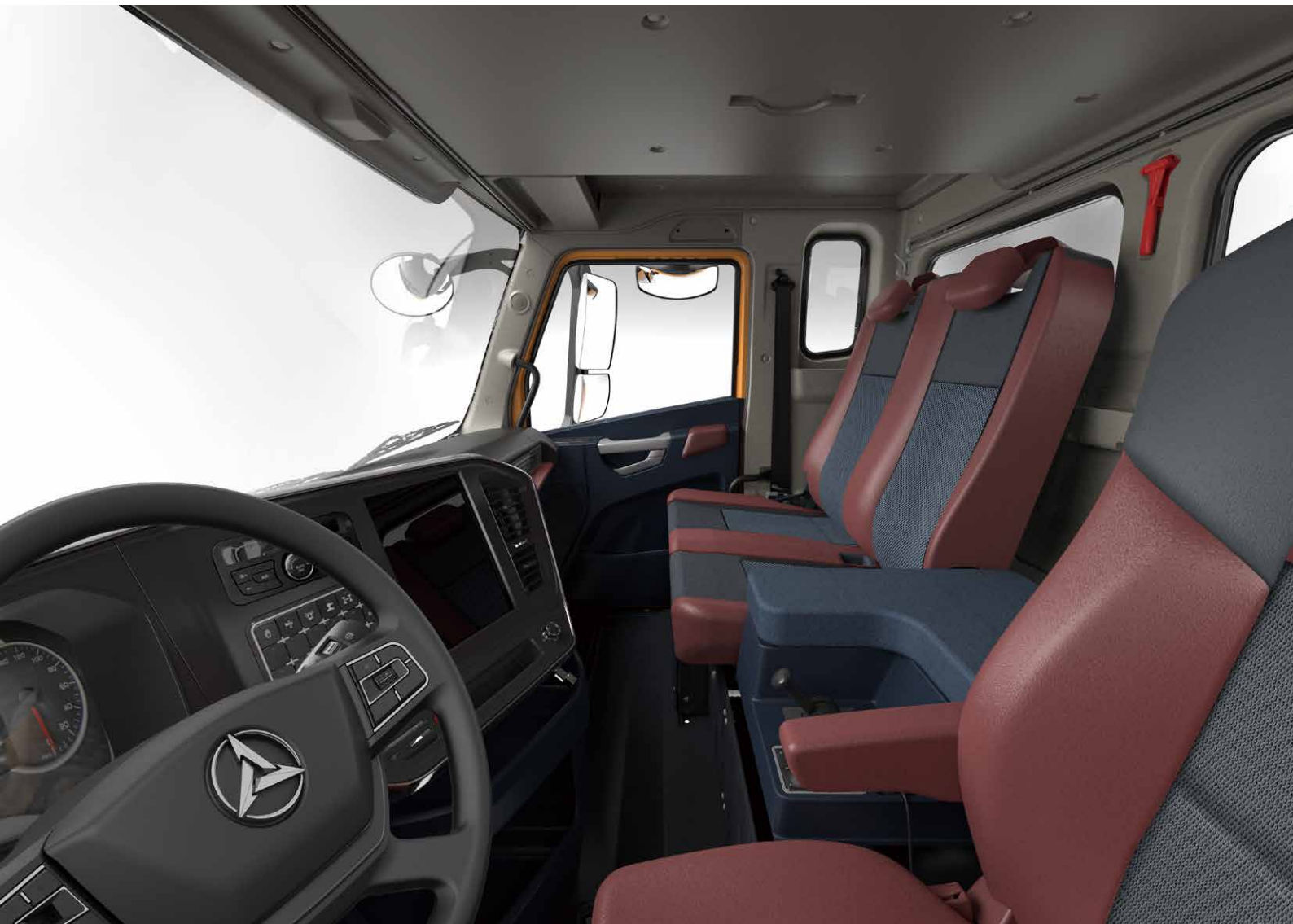



i-Cab - Operator's Cab

新两室 - 操纵室

Seat widened by 450mm, and leg room increased by 30%.
Cab tiltable by 0-20°, relieving cervical fatigue during large-angle and long-boom operations.
Adjustable seat with maximum inclination of 140°, allowing the operator to lie flat and rest after work
Electric seat linked with armrest box, enabling multi-dimensional adjustment for enhanced comfort.
Electronic control joysticks, making operation easier.
45° tilted silicone button panel, easy to reach and operate.
70° openable front window convenient for ventilation and escape; in compliance with CE standards.
Sliding door, more convenient for getting on/off the cab and opening/closing the door.
Full-automatic HVAC, able to automatically adjust indoor temperature as demanded.

座椅加宽至450mm，腿部活动空间较上一代增加30%。
操纵室可实现0-20°上仰变位，在大角度、长臂段作业时减缓颈椎疲劳。
可调式座椅，最大后仰140°，让操作手可以平躺休息。
电动座椅+扶手箱联动，多维度调节，更加舒适。
电控操纵手柄，操作毫不费力。
45°斜置硅胶按键面板，触手可及，方便操控。
70°可开启式前窗，方便通风及逃生、操作室满足CE要求。
手动滑移门，上下车、开关门更方便。
全自动冷暖空调，自动根据需求调整室内温度。



Anti-electromagnetic Interference

抗电磁干扰

Anti-electromagnetic interference module, allowing the crane to work normally in strong electric field or strong magnetic field ($\leq 20\text{V/m}$ and $>500\text{m}$ away from interference source), including cluster construction of high-power equipment, and the vicinity of multiple interference sources including high-voltage lines, broadcasting base stations, power plants, aluminum plants, radar stations, military bases or mobile communication stations.

配备抗电磁干扰模块，实现在磁场强度不大于 20V/m 、距干扰源 500m 范围外的强电场、强磁场，如大功率设备集群化施工，紧邻高压线、广播基站、电厂、铝厂、雷达基站、军事基地或移动设备等通信基站附近多个干扰源的环境中正常工作。



Wireless Remote Control System

无线遥控系统

Independently developed remote controller in compliance with European and US regulations and CE certified, realizing functions as electronic, smart and digital control as well as one-button extension and retraction, making operation very convenient.

Main functions

Outrigger control - single-piece / single-side outrigger beam and jack telescoping in/out, and one-button leveling;

One-button set-up - automatic boom telescoping, luffing, slewing, hoisting;

Auxiliary action control - counterweight lifting/lowering, jib pushing/pulling, side step extension/retraction, cab tilting, etc.



自主产权的遥控器，实现电控化，智能化、数字化、一键展车和收车功能，非常方便。并且符合欧美法规要求并已经通过 CE 认证。

主要功能

支腿控制——单个和单边支腿水平伸缩、垂直起落，并支持一键调平；

一键展/收车——自动实现伸缩臂、起落幅、回转、卷扬收放绳；

辅助动作操作——配重起落、副臂推拉、踏板伸缩、操作室变位等辅助操作。



- Outrigger status 支腿界面
- Counterweight lifting/lowering, step extension/retraction 配重起落、踏板伸缩
- Main parameters 主参数展示界面
- Boom telescoping 起重臂伸缩界面

Working Condition

工况组合

T: Boom

主臂

Max. lifting capacity 最大起重量	120t
Max. boom length 最长臂	66m
Max. radius 最大幅度	54m
Max. height 最大高度	66m

TF: Boom + fixed jib*

主臂 + 固定副臂*

Max. lifting capacity 最大起重量	5.1t
Max. boom length 最长臂	66m+18.7m
Max. radius 最大幅度	60m
Max. height 最大高度	84m

THJ: Boom + hydraulically adjustable jib*

主臂 + 液压变幅副臂*

Max. lifting capacity 最大起重量	5.1t
Max. boom length 最长臂	66m+18.7m
Max. radius 最大幅度	60m
Max. height 最大高度	84m

TEF: Boom + extension + fixed jib*

主臂 + 延伸臂 + 固定副臂*

Max. lifting capacity 最大起重量	4.3t
Max. boom length 最长臂	66m+25.7m
Max. radius 最大幅度	60m
Max. height 最大高度	91m

TEHJ: Boom + extension + hydraulically adjustable jib*

主臂 + 延伸臂 + 液压变幅副臂*

Max. lifting capacity 最大起重量	4.3t
Max. boom length 最长臂	66m+25.7m
Max. radius 最大幅度	60m
Max. height 最大高度	91m

TAJ: Boom + auxiliary jib*

主臂 + 鹅头臂*

Max. lifting capacity 最大起重量	29.1t
Max. boom length 最长臂	66m+2.9m
Max. radius 最大幅度	52m
Max. height 最大高度	68.5m

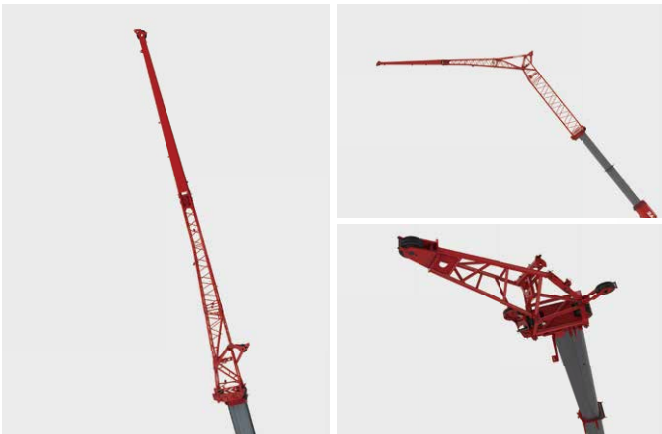

*Optional 选配



Power Train

动力系统

Chassis engine

Mercedes-Benz OM471LA in-line six cylinder water-cooled diesel engine, complying with EU Stage III or EU Stage V emission standards.
Rated power: 360kW/1600rpm.
Max. torque: 2400Nm/1300rpm.
Fuel reservoir capacity: 400L.

Crane engine

Mercedes-Benz OM934LA off-road in-line four cylinder water-cooled diesel engine, complying with EU Stage III or EU Stage V emission standards.
Rated power: 150kW/1800rpm.
Max. torque: 850Nm/1200rpm.
Fuel reservoir capacity: 220L.

Transmission

ZF Traxon AT.

Braking system

Braking system consisting of Knorr disc brake, WABCO air chamber and WABCO ABS, more reliable and efficient. Hydraulic retarder protects engine when driving down long slope and avoids locking when braking on slippery roads, allowing for effective assist braking, reducing the wear of axle brake linings and prolonging service life. Parking brake and service brake equipped for axles 1, 2, 3.

Axles and suspension

Kessler axles with high bearing capacity and reliable quality. Hydro pneumatic suspension system with stroke of -100/+100mm. Standard 8 × 6, with axles 2, 3, 4 driven. Optional 8 × 8, with all axles driven.

Steering system

Bosch dual-circuit power steering gear, with all axles steered.

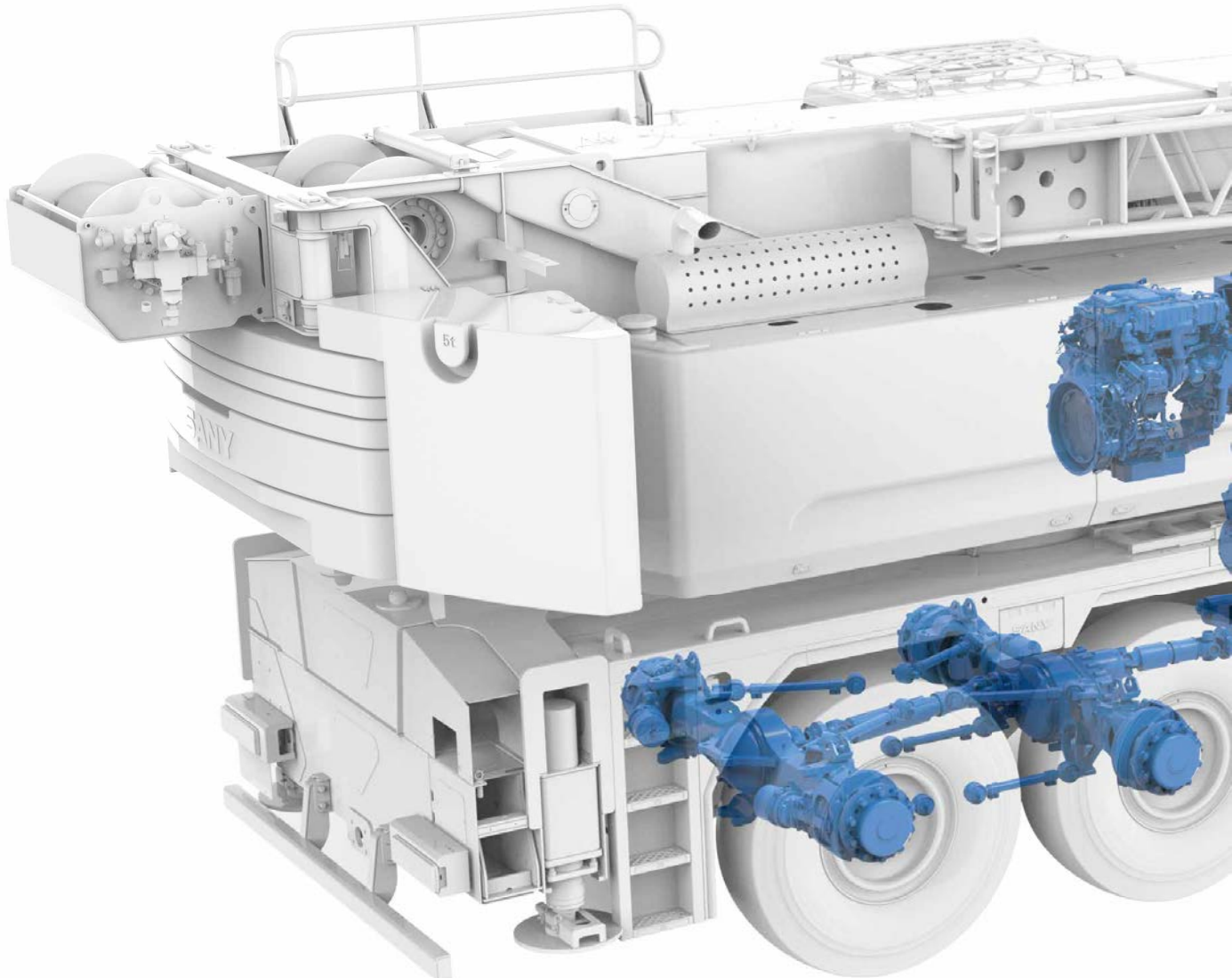

底盘发动机

奔驰OM471LA直列6缸水冷柴油机，可满足欧三、欧五排放法规要求。

额定功率：360kW/1600rpm。

最大扭矩：2400Nm/1300rpm。

燃油箱容积：400L。

上车发动机

奔驰OM934LA非道路直列4缸水冷柴油机，可满足欧三、欧五排放法规要求。

额定功率：150kW/1800rpm。

最大扭矩：850Nm/1200rpm。

燃油箱容积：220L。

变速箱

ZF Traxon自动变速箱。

制动系统

由Knorr盘式制动器，WABCO制动气室，WABCO ABS主要配件系统组成，制动性能更加可靠、高效。液力缓速器，长下坡时有效保护发动机，滑路制动车轮减少滑移，可有效进行辅助制动，减少车桥制动片磨损，提高制动片使用寿命。

车桥悬架

Kessler车桥，承载能力强，质量可靠。采用油气悬挂系统，悬挂行程-100/+100mm。

标配8×6驱动模式，2、3、4桥为驱动桥。

选配8×8驱动模式，全桥驱动。

转向系统

Bosch双回路助力转向器，双回路转向助力系统，全轮转向。

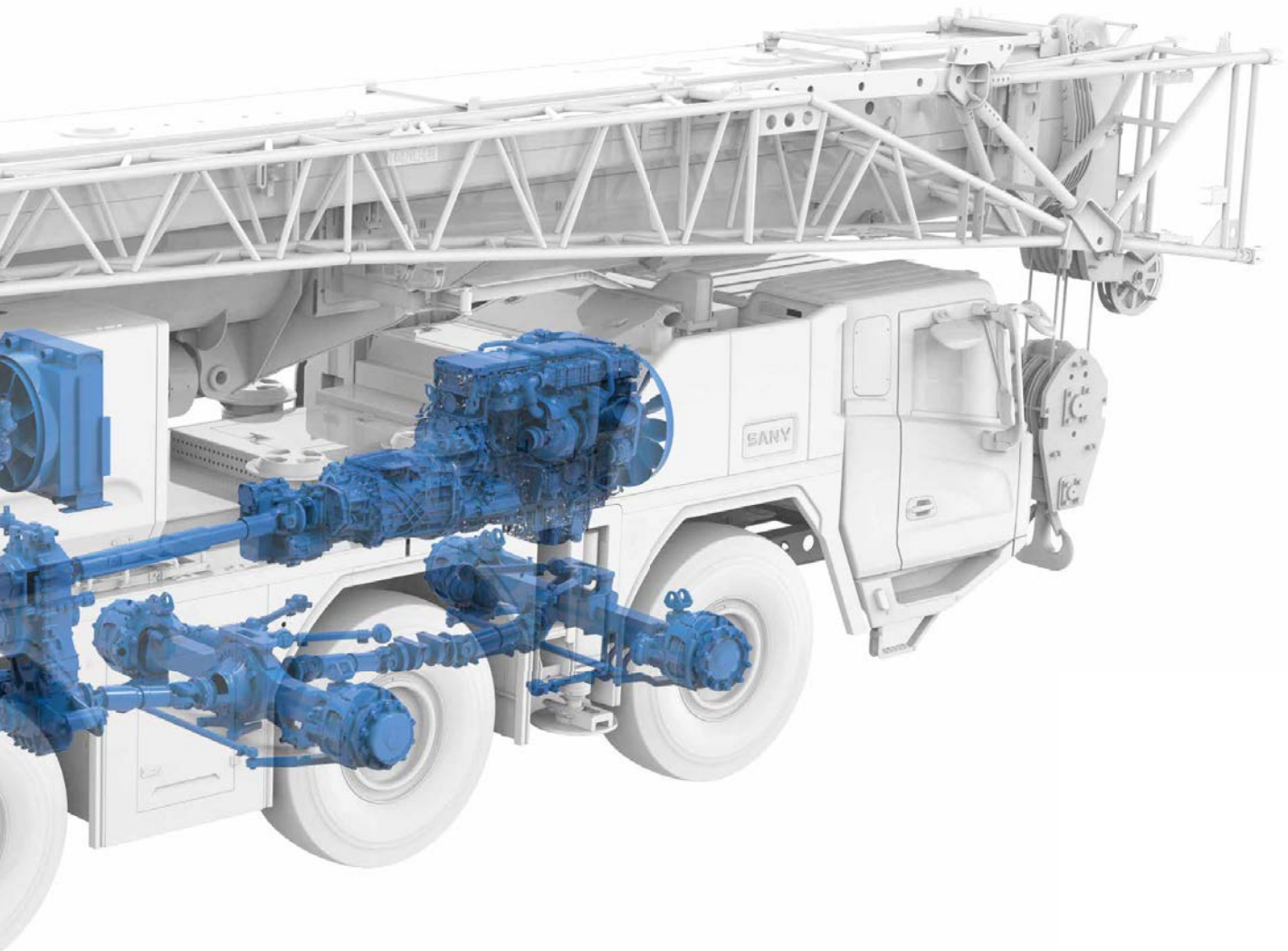

Electrical System

电气系统

Smart CAN-BUS communication system

International advanced CAN-BUS data communication network. Safety controller of redundant design featuring fault diagnosis (conforming to EN13000 standard). CAN-BUS networking applied for display, instrument panel, I/O module and main sensors, allowing for high-speed data transmission, and quick response less than 20ms.

Smart fault diagnosis system

Safety controller functions monitoring, BCM power distribution management and is integrated with fault diagnosis system, enabling accurate fault location, and convenient inspection and maintenance.

AEC-approved console screen

Integrating functions including suspension control, steering control, outrigger control and data calibration

Precise load moment indicator

SANY independently developed LMI, with an accuracy of 0 ~ 5%.

Cabling

Centralized junction box and heavy-duty connector applied for cabling of superstructure, convenient for maintenance; IP rating up to IP67, ensuring high reliability.

Winch monitoring system

Winch cameras equipped for monitoring its working condition and identifying rope disorder in time.

Integrated bus button panel input

Various operating states displayed by button indicator lights, and one-button multi-functional operation realizable by writing various operation modes.

智能总线通信系统

国际先进的分布式集成总线数据通信网络。整车采用安全控制器（符合欧盟EN13000标准，冗余设计，自带故障诊断）。显示器、显示仪表、I/O模块、主要传感器等采用CAN总线组网，高速信息传输、响应速度小于20ms。

智能故障诊断系统

采用安全主控制器操作装置带智能监控、BCM配电管理，拥有故障诊断系统，能精准定位故障点，方便检修。

车规级中控屏

集成悬挂、转向、支腿、数据标定等作业功能。

精准力限器系统

三一自主研发的力矩限制器系统，精度达0-5%。

电缆布线

上车电缆布线采用集中式分线盒及重载接插件，维护方便；防护等级IP67，可靠性高。

卷扬监控系统

卷扬摄像头监视卷扬工作及时发现乱绳的情况。

集成总线按键面板输入

可通过按键指示灯显示各种工作状态，通过写入多种操作模式实现一键多功能。



Anti-two-block switch
高度限位器



Third wrap indicator
三圈保护器



Cable reel
电缆卷筒



Cable reel inside the boom
臂内卷筒



Anemometer
风速仪

MachineLink+

ROOTCLOUD T-AMS Pro device comes as standard to realize GPS trajectory, machine status, maintenance management, E-fence, alarm management, and operator management on computer or mobile MachineLink+ platform, by remote control of cranes. This telematics package greatly boosts efficiency of customer fleet management and helps provide better after-sales services.

标配树根物联终端T-AMS Pro，通过对起重机设备的远程控制，在电脑或移动端MachineLink+平台实现轨迹回放、设备状态、维保设备、电子围栏、报警管理、操作手管理等功能，极大提高客户设备管理效率，提升三一售后服务能力。

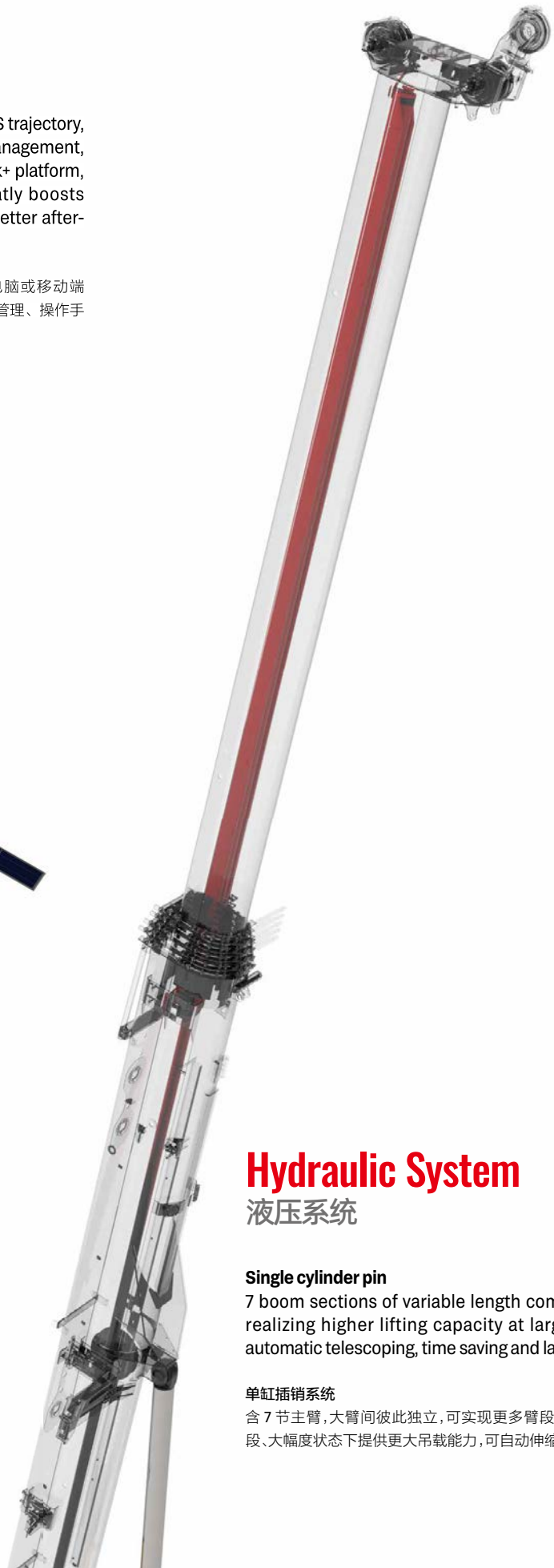
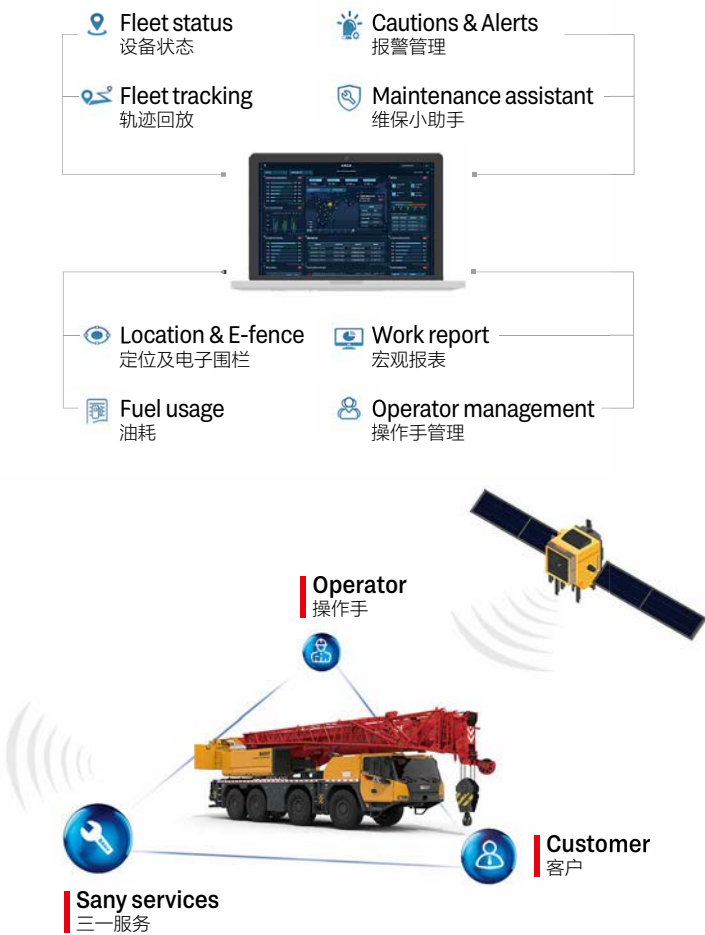

Hydraulic System 液压系统

Single cylinder pin

7 boom sections of variable length combinations, realizing higher lifting capacity at larger radius; automatic telescoping, time saving and labor saving.

单缸插销系统

含7节主臂，大臂间彼此独立，可实现更多臂段组合，为长臂段、大幅度状态下提供更大吊载能力，可自动伸缩，省时省力。

Superstructure

上车

Open-type electronically controlled load-sensing system and closed-type slewing system, enabling combined operation of four actions at the same time.

Electro proportional compensated passive luffing-down system applied to control the luffing speed, making luffing more reliable and stable.

Closed-type slewing system, ensuring no pressure loss and no overflowing noise upon start/stop, and making the operation quieter and more energy-saving.

Electronically controlled load-sensing hydraulic system, electronic joystick and electronic throttle, ensuring easy operation and more accurate control and millisecond-level action response speed, with min. single-rope hoisting speed $\leq 1\text{m/min}$, and distribution difference in case of combined motions $\leq 8\%$.

通过开放式电控负载敏感系统和闭式回转系统，可同时实现四动作联动。

电比例自重落幅系统控制落幅速度，更可靠更平稳。

采用闭式回转系统，启停时无压力损失，无溢流噪声，更安静，更节能。

电控负载敏感液压系统，采用电手柄、电油门控制，轻松操作的同时，控制更精准；动作响应毫秒级速度；卷扬单绳最低速度 $\leq 1\text{m/min}$ ；复合动作分配误差 $\leq 8\%$ 。

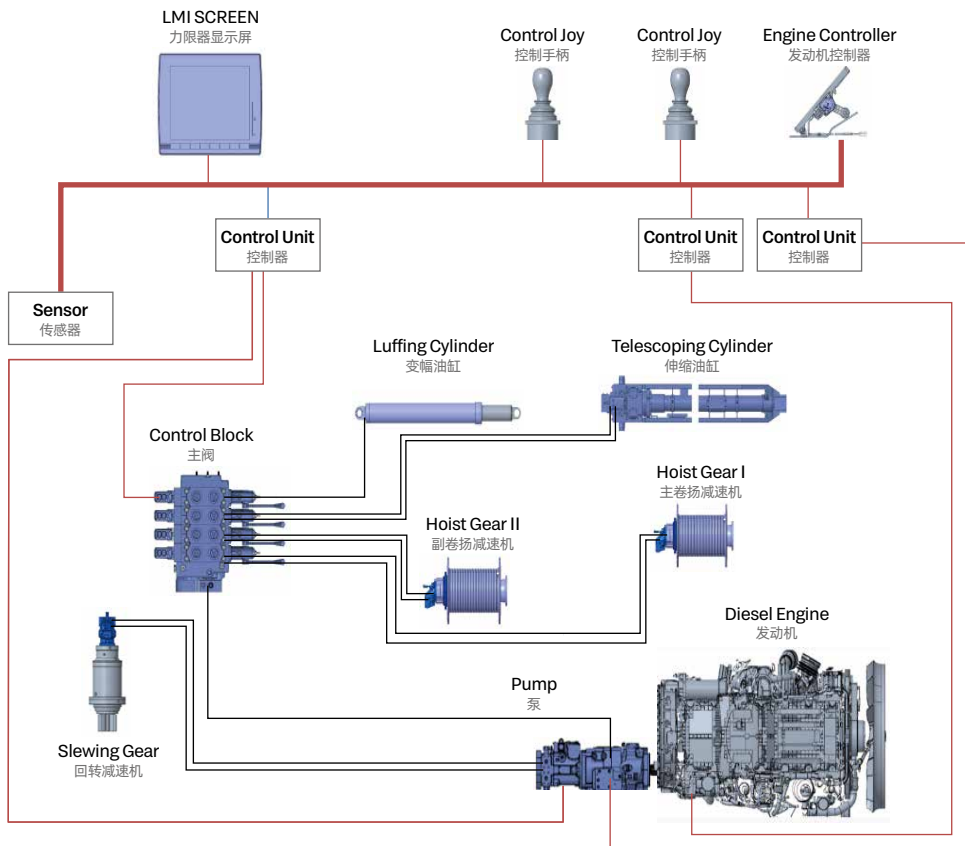

Chassis

下车

Dual circuit + emergency main steering system

Main steering system: Dual oil pump directly connected to the engine to supply oil independently to the steering gear, ensuring efficient and reliable steering.

Emergency steering system: A Rexroth bidirectional piston pump installed on the transfer case, ensuring steering assistance throughout the traveling.

Electro-hydraulic assisted steering system

A Rexroth load-sensing piston pump installed to supply oil for assisted steering, which is directly connected to the engine and always in the standby mode, so that the assisted steering system can respond quickly once the assisted steering command is received.

A large-capacity accumulator installed as back energy to support limited times of normal assisted steering when the power is lost.

Suspension system

A Rexroth piston pump adopted as the power source of suspension system, and suspension modes electrically controlled to realize normal driving and driving with CW on board with suspension locked; suspension to be locked when the crane is operating.

Outrigger telescoping system

Full-electric control of outrigger, realizing arbitrary telescoping and auto leveling.

双回路+应急主转向系统

主转向系统：双联油泵与发动机直连，独立对方向机供油，主转向高效、可靠。

应急转向系统：采用力士乐双向柱塞泵，安装在分动箱上，确保车辆行进过程中始终有转向助力。

电液辅助转向系统

辅助转向采用力士乐负载敏感柱塞泵提供油源，该油泵与发动机直连，油泵始终处于转向待机模式，一旦接到辅助转向指令，辅助转向系统能够快速响应。

使用大容量蓄能器作为备用能源，在失去动力的情况下，可以做到有限次数的正常辅助转向。

悬挂系统

悬挂系统采用力士乐柱塞泵作为动力油源，操作方式采用电控，通过选择不同的悬挂模式可以实现正常行驶和锁定模式下的带载行驶；在起重机上车作业时能够对悬挂进行锁定。

支腿伸缩系统

支腿伸缩采用全电控方式，可实现支腿的无级伸缩，电控模式下可实现整车自动调平。

Overall Dimensions

整机尺寸

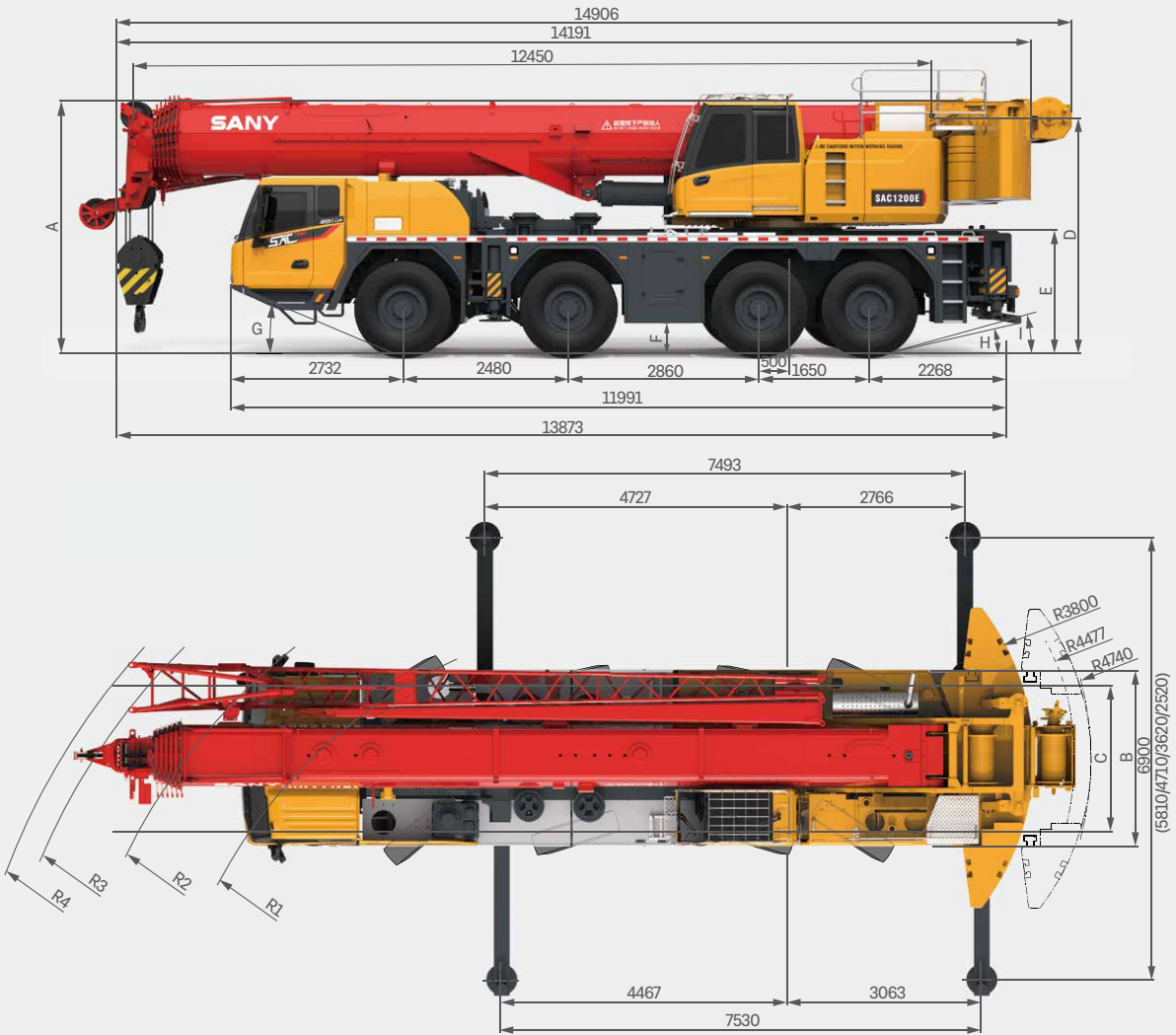

Tire size 轮胎尺寸	A	A*	B	C	D	E	F	G	H	I	R1	R2	R3	R4
Unit 单位	mm	mm	mm	mm	mm	mm	mm	°	°	°	mm	mm	mm	mm
385/95R25 (14.00 R25)	3950	3850	2750	2337	3680	1876	300	22	12	18	7890	9365	10390	10910
445/95R25 (16.00 R25)	4000	3900	2750	2277	3730	1926	350	23	14	19	7850	9420	10385	10905
525/80R25 (20.5 R25)	4000	3900	2897	2367	3730	1926	350	23	14	19	7870	9320	10340	10855

Remark: The stroke of suspension cylinder : -100mm~+100mm.

* Lowered

悬挂油缸行程: -100mm~+100mm

* 低位







Technical Specification

整机参数

CATEGORY 类型	ITEM 项目	UNIT 单位	VALUE 参数	
CAPACITY 额定起重量	Max. lifting capacity 最大起重量	t	120	
WEIGHT 重量参数	Gross weight 整机总质量	kg	48000	
POWER (CHASSIS) 发动机参数 (下车)	Engine model 发动机型号	-	OM471LA	
	Max. engine power 发动机最大功率	kW/rpm	360/1600	
	Max. engine torque 发动机最大输出扭矩	N·m/rpm	2400/1300	
POWER (SUPERSTRUCTURE) 发动机参数 (上车)	Engine model 发动机型号	-	OM934LA	
	Max. engine power 发动机最大功率	kW/rpm	150/1800	
	Max. engine torque 发动机最大输出扭矩	N·m/rpm	850/1200	
DIMENSIONS 尺寸参数	Overall length 整机全长	mm	14200	
	Overall width 整机全宽	mm	2750	
	Overall height 整机全高	mm	4000	
TRAVEL 行驶参数	Max. travel speed 最高行驶速度	km/h	80	
	Steering radius 转弯半径	Min.steering radius 最小转弯半径	mm	7850
		Min.steering radius of boom tip 臂头最小转弯半径	mm	10350
	Wheel formula 车轮模式	-	8 × 6 × 8	
	Min.ground clearance 最小离地间隙	mm	300	
	Approach angle 接近角	°	23	
	Departure angle 离去角	°	14	
	Max.gradeability 最大爬坡度	-	59.5%	
	Fuel consumption per 100km 每 100 公里油耗	L	70	
	MAIN PERFORMANCE 主要性能参数	Working temperature range 使用温度区间	°C	-20~45
Min.rated lifting radius 最小额定幅度		m	3	
Tail slewing radius 转台尾部回转半径		m	3.8 / 4.47 / 4.74	
Boom sections (Qty.) 臂节数		-	7	
Boom shape 臂形状		-	U shape U 型	
Max.lifting moment 最大起重力矩		Basic boom 基本臂	kN·m	3300
		Full-extension boom 全伸主臂	kN·m	1708
		Max.combination of boom + jib 最大主臂 + 副臂组合	kN·m	720
Boom length 臂长		Basic boom 基本臂	m	12.45
		Full-extension boom 全伸主臂	m	66
		Max.combination of boom + jib 最大主臂 + 副臂组合		91.7
Max.lifting height 最大起重高度		Basic boom 基本臂	m	12.6
		Full-extension boom 全伸主臂	m	66
		Max.combination of boom + jib 最大主臂 + 副臂组合	m	91
Outrigger span (Longitudinal × Transverse) 支腿跨距 (纵 × 横)		m	7.49 × 6.9	
Jib offset 副臂安装角度	°	0, 20, 40		
AIRCONDITIONER 空调	In operator's cab 上车空调	-	Heating & Cooling 制冷、制热	
	In driver's cab 下车空调	-	Heating & Cooling 制冷、制热	

Technical Specification

整机参数

	Total					
< 12t	48t	8 × 6	385/95R25 steel	-	0.25t	0.4t
< 12t	48t	8 × 8	385/95R25 steel	-	-	0.25t
< 12t	48t	8 × 6	445/95R25 steel	-	-	-
< 12t	48t	8 × 8	445/95R25 Alu	-	-	0.18t
< 12t	48t	8 × 6	525/80R25 Steel	-	-	-
< 14.5t	58t	8 × 8	445/95R25 Alu	9.3t	0.7t	0.5t
< 16.5t	66t	8 × 8	445/95R25 Alu	17.2t	0.7t	0.5t



Speed and Gradeability 速度和爬坡能力

Tire size 轮胎型号	Min. travel speed 最低速度	Max. travel speed 最高速度	Max. gradeability 最大爬坡度
385/95R25 (14.00 R25)	1.9km/h	80km/h	59.5%
445/95R25 (16.00 R25)	2.1km/h	80km/h	56.5%
525/80R25 (20.5 R25)	2.1km/h	80km/h	56.5%



Operations 主要动作参数

Item 项目	Working speed 作业速度	Rope diameter/length 钢丝绳直径	Rope length 长度	Max. single line pull 最大单绳拉力
Main winch 主卷扬	0-120 m/min	19mm	280m	74kN
Auxiliary winch 副卷扬	0-120 m/min	19mm	250m	74kN
Slewing 回转	0-1.8 r/min			
Luffing 变幅	Approx. 60s to reach 83°			
Telescoping 伸缩	Approx. 550s from 12.5m to 66m			



Hook 吊钩

Type 型号	Load 起重量 /t	Number of sheaves 滑轮数量	Rope rate 倍率	Hook weight/kg 吊钩重量	Remarks 备注
QZG80.19S	70t	5	11	900	Double eyes 双钩
QZG50.19S	49.8t	3	7	700	Double eyes 双钩
QZG25.19	22t	1	3	520	Single eye 单钩
QZG10.19	7.4t	-	1	250	Single eye 单钩

Travel Flexibility

通过能力

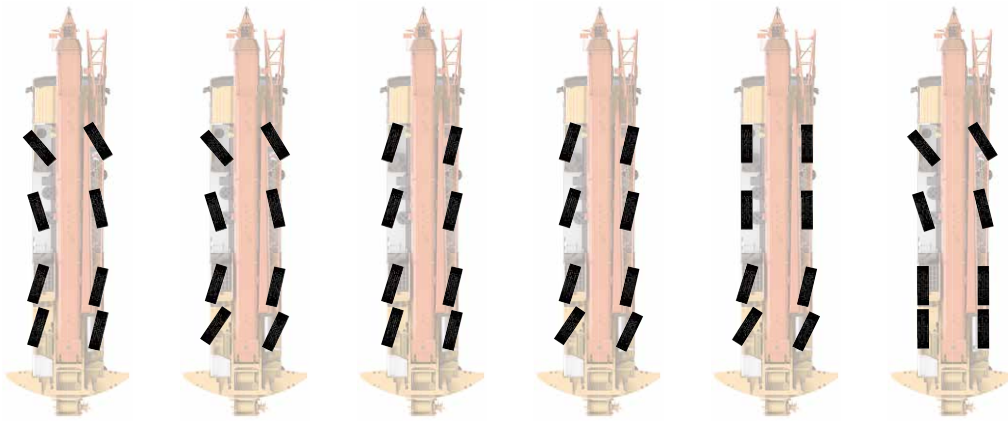

On-road driving 公路行驶

All-wheel steering 全轮转向

Crab steering 蟹行

Reduced swing-out steering 无偏摆转向

Independent rear axle steering 独立后桥转向

Independent front axle steering 后桥锁定转向

Traveling with counterweight and hook block on board

带载行驶能力



≤12t ≤12t ≤12t ≤12t

🚛 0t



14.5t 14.5t 14.5t 14.5t

🚛 9.3t



16.5t 16.5t 16.5t 16.5t

🚛 17.2t

Counterweight Combinations

配重组合



Total weight (t) 总重量	①	②	③	④	⑤	⑥	⑦
6.4t	•						
9.3t	•		•				
12.2t	•	•					
15.1t	•	•	•				
17.2t	•	•	•	•			
21t	•	•	•	•	•		
31t*	•	•	•	•	•	•	•

* Optional 选配

Transport Dimensions

运输尺寸

Unit:mm

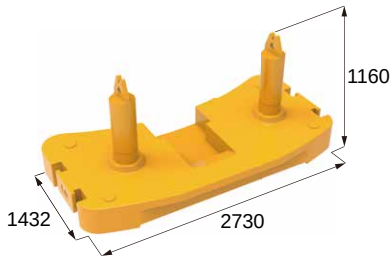

6.4t

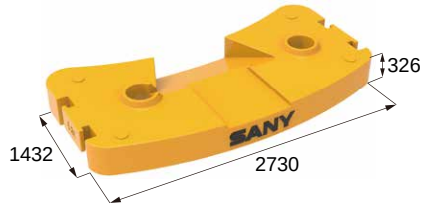

5.8t

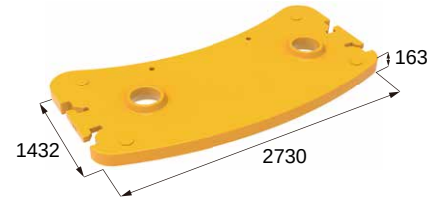

3.8t

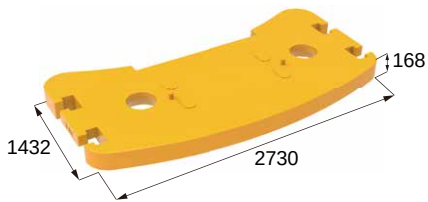

2.9t

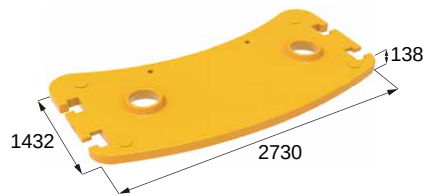

2.1t

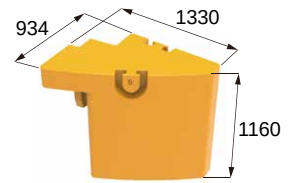

5t*2

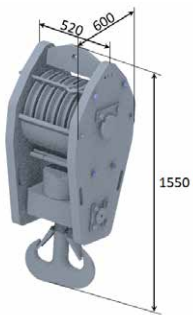

QZG80.19S

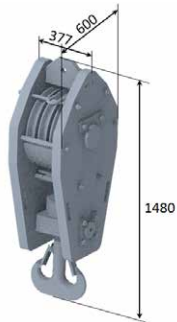

QZG50.19S

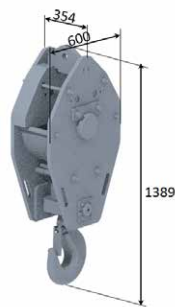

QZG25.19



QZG10.19

Jib Combinations

副臂组合

Lengths 长度	Combinations 组合
2.9m	①
10.4m	③
10.4m+8.3m	③ + ④
7m+10.4m	② + ③
7m+10.4m+8.3m	② + ③ + ④

① 567kg

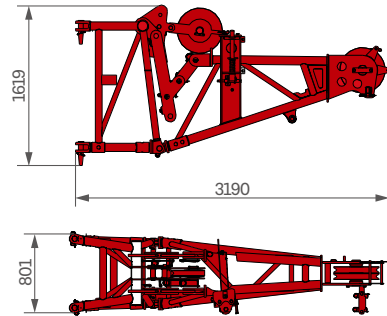

② 594kg

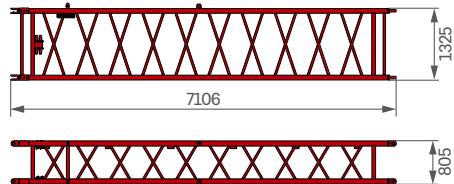

③ 1073kg

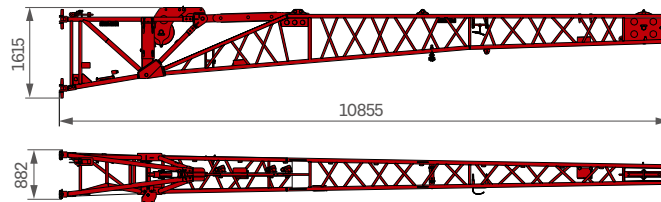

④ 355kg

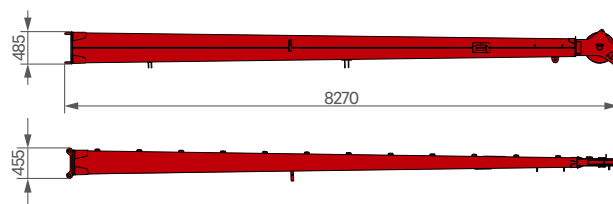

Crane Introduction

整机介绍

Carrier 下车

Driver's cab 驾驶室

- Keyless entry through two opposing doors, three seats with a folding berth. Its soundproofing performance meets the standard of heavy-duty trucks. Air suspension seat features shock absorption, back adjustment, lumbar support and other ergonomic designs. Virtual LCD instrument and 12.1" console screen integrate auto control of air conditioning. Indoor temperature can be adjusted precisely and smoothly. LED headlights, electrically heated rear-view mirrors, multi-function steering wheel. The multi-media can be controlled by the buttons integrated in the steering wheel.
- 无钥匙进入，左右贯通式设计，三座椅，二合一卧铺。车门关闭后，隔音性能达到国际重卡水平。空气悬浮减震座椅，集成背部调节、气囊腰托、人体工程学配置。液晶、虚拟仪表盘。12.1 寸中控大屏；集成自动空调控制界面，精准控温，出风柔顺。LED 前大灯，电动电热后视镜；多功能方向盘，可控制车内多媒体设备。

Carrier frame 车架

- Manufactured by SANY, the torsion resistant box-type structure is welded by fine grain high-strength steel.
- 由高强度细晶粒结构钢制成的低扭矩箱形结构，三一制造。

Engine 发动机

- Model: BENZ inline six-cylinder diesel with watercooler. Electronically controlled.
- Rated power: 360kW/1600rpm.
- Max. torque: 2400Nm/1300rpm.
- Emission standard: EU StageV.
- Fuel reservoir capacity: 400L.
- 型号：奔驰直列六缸水冷电控柴油发动机。
- 额定功率：360kW/1600rpm。
- 最大扭矩：2400Nm/1300rpm。
- 排放标准：欧五。
- 燃油箱容积：400L。

Transmission 变速箱

- ZF AMT, 12 forward gears, 2 reversing gears. Gear shift is pneumatically powered and electrically controlled.
- 德国 ZF 自动挡变速箱，12 个前进档，2 个倒档，电控气动换挡。

Transfer case 分动箱

- KESSLER mechanical shift transfer case enjoys large output torque. With emergency steering oil pump mounted, the vehicle can still steer when engine fails.
- 德国 KESSLER 机械式分动箱，输出扭矩大。装有应急转向油泵，当车辆失去动力被拖动时，实现转向动力。

Axle 车桥

- KESSLER high-strength axles are coupled with air disc brakes.
- 德国 KESSLER 高强度车桥，配备气控盘式制动器。

Outrigger 支腿

- H-type layout, four point support, one stage outrigger beam. Hydraulically controlled telescoping out and down. Five positions of 0%, 25%, 50%, 75%, and 100% boost flexibility. Working safety is further enhanced via ground pressure sensors and protectors.
- 4 支腿，H 形布置，采用单级水平支腿，水平伸缩和垂直伸缩由液压控制，带推拉式支脚盘，有全收、25%、50%、75% 和 100% 作业位置，并装有支腿压力检测与保护装置，提升作业安全性。

Suspension system 悬挂

- All axles adopt hydro-pneumatic suspension functioning good shock absorption, auto-levelling, shift of rigidity and resilience. The cylinder stroke ranges -100mm~+100mm.
- 所有车桥均采用油气悬挂系统，减震效果好，具有自动调平、悬架升降、弹性刚性转换等功能。
- 悬架油缸行程：-100mm~+100mm。

Steering 转向系统

- All wheel steering. Cutting edge electro-hydraulic proportional steering mechanism ensures multiple steering modes, maximizing flexibility on various terrain conditions.
- 全桥转向，采用先进的电液比例转向控制技术，可适应多种工况的要求，实现多种转向模式。

Tires 轮胎

- 8 tires sized 385/95R25 (14.00R25), high bearing capacity.
- 8 个轮胎，每桥均装单胎，承载力大。轮胎规格：385/95R25 (14.00R25)。

Wheel formula 车轮模式

- 8 × 6 × 8.

Brake 制动系统

- Service brake: double circuit air brake functioning on all axles.
- Parking brake: performed by spring loaded accumulator on axle 2, 3, and 4.
- Assisting brake: Engine brake, exhaust brake, transmission hydraulic retarder brake.
- 行车制动：双回路气压制动，作用于所有车轮。
- 驻车制动：弹簧储能制动，作用于 2、3、4 轴车轮。
- 辅助制动：发动机制动，变速箱缓速制动。

Electrical system 电气系统

- 24V DC. Brand new intelligent control. With remote control of the whole machine, it satisfies prioritized safety, driving convenience, and easy operation.
- 整车采用直流 24V 系统，搭载全新设计的智能化操控平台，配备整车遥控系统，在保证安全的基础上，充分兼顾驾驶方便以及操作简单的要求。

Electrical system 液压系统

- The electro-hydraulic assist steering system functions electro proportional load sensing. Two options can be made between self-made system of self centering and a full set of imported ME electro-hydraulic assist steering system. The main steering hydraulic system is designed of maximized reliability with the equipment of dual circuit integrated steering gear, dual steering pumps and constant flow radial piston pump. Suspension reliability is also upgraded with the new suspension hydraulic system.
- 电液辅助转向系统采用电比例负载敏感系统功能，可选装自制具备双活塞式蓄能器作为备用油源、主动对中、转向的自制转向系统或全套进口 ME 电液辅助转向系统；主转向液压系统同时具备双回路集成式转向机、双联主转向泵、恒流量径向柱塞泵；最大限度提升主转向可靠性；新升级悬挂液压系统，提升悬挂可靠性。

Crane Introduction

整机介绍

Superstructure 上车

Operator's cab 操纵室

- Curved track sliding door, foldable front step and remote-controlled electric side step. The seat and armrest box can be adjusted steplessly in multi dimensions. Auto air conditioning system gives out airflow from various outlets once pressing the virtual key. Windshield wiper covers large area, ensuring clear vision in heavy rains. 10.1" frameless display of all new UI is equipped. Operation is made via touchscreen, knob and buttons.
- 变轨滑移门；遥控电动滑移踏板、折叠式前踏板；座椅、扶手箱多维度电动无极调节；汽车级集成式硬质按键；配置全自动空调，多通道立体送风系统，虚拟空调按键；前窗分体式大面积雨刮；10.1寸无框大屏，全新UI界面，触摸、旋钮、按键多模式操作。

Slewing platform 转台

- Made by SANY with highly-durable fine grain structural steel, the box type slewing platform is torsion resistant. A single-roll ball bearing which can rotate by 360° and functions auto lubrication is mounted on carrier frame.
- 三一制造，由高耐用的细晶粒结构钢制成，抗扭箱形结构，一个单排球的回转支承安装在底盘架上，可360°回转，含集中润滑系统。

Engine 发动机

- Model: BENZ inline four-cylinder diesel with watercooler. Electronically controlled.
- Rated power: 150kW/1800rpm.
- Max. torque: 850Nm /1200.
- Emission standard: EU Stage V.
- Fuel reservoir capacity: 220L.
- 型号：奔驰直列四缸水冷电控柴油发动机。
- 额定功率：150kW/1800rpm。
- 最大扭矩：850Nm /1200rpm。
- 排放标准：欧五。
- 燃油箱容积：220L。

Hydraulics 液压系统

- Major motions of crane are controlled by electro proportional dual piston pumps and high precision electro proportional load sensing hydraulic valve, which realizes simultaneous smooth actions. The constant power electric control also lifts engine efficiency while cutting fuel cost. The closed type slewing system functions noiselessly, effectively and smoothly.
- 上车主动作采用电比例柱塞泵双泵+进口电比例LUDV主阀组成的高精度电比例负载敏感系统主动作系统，可实现所有动作复合动作，实现小流量平稳，复合动作冲击小，大流量节能；主动作液压系统采用电控恒功率控制，提升发动机利用效率，降低油耗。闭式回转系统，静音、节能、平稳。

Crane control 操纵方式

- Electro proportional control. It can realize stepless speed regulation and simultaneous functioning of all main motions.
- 采用电控比例控制，主动作、回转控制无级调速的同时，最大可实现所有动作进行复合动作。

Hoist 起升机构

- Driven by electro proportional axial piston motor, hoisting features high efficiency and low energy consumption, fitted with planetary gear reducer and normally closed type brake. It's remarkably stable at low working speed. Lebus grooves and top brand wire ropes make it more reliable.
- 电比例轴向柱塞液压马达驱动，高速节能，低速稳定性好，内置行星齿轮减速机和常闭式制动器。双折绳槽卷筒，进口钢丝绳，配置袋式索具。

Slewing 回转系统

- single-roll ball slewing bearing with external gears. Slewing is powered by close type hydraulics with built in planetary reducer gear and normally closed brake. The continuous 360° rotation is controlled electro proportionally. More functions include smooth and precise start/stop, stepless speed regulation, anti diagonal tension crack, and free swing.
- 单排球外齿式回转支承，闭式液压系统驱动，内置行星齿轮减速器和常闭式制动器，可连续回转360°，电比例控制，启动停止平稳，精准，无级调速、自由回转、防斜拉功能、自由滑转应有尽有。

Safety equipment 安全装置

- Electro proportional luffing balance valve, large flow telescoping balance valve, and relief valve are made by globally top brands.
- Three-circle protector prevents wire rope from over-hoist down.
- Height limit switch at boom head prevents wire rope from over-hoist up.
- Anemometer measures wind speed displayed in realtime.
- 电比例变幅液压平衡阀、大流量伸缩平衡阀、所有溢流阀均为国际品牌；
- 三圈保护器，防止钢丝绳过放；臂头设置高度限位，防止钢丝绳过卷；
- 风速仪，检测高空风速。

Load moment indicator 力矩限制器

- LMI alerts the operator audibly when actual load is close to payload and cuts off risky motions by itself before overload. Blackbox of overload memory and fault self-diagnosis are making it safer to operate the crane.
- 力矩限制器在实际力矩接近过载时，发出听觉警报，并在过载之前自动停止危险动作。具有超载记忆功能（黑匣子）和故障自诊断功能。

Boom & telescoping system 主臂

- Seven section U shape 12.5m-66m boom. Single-cylinder pinning interlocked telescoping system, 46%, 92% and 100% telescoping pattern are available.
- 7节，“U”形截面的筒形焊接结构。单缸插销伸缩机构，有46%、92%和全伸模式可供选择。主臂长度：12.5m-66m。

Counterweight 配重

- 21t in total. See details in counterweight chart. 940mm displacement allows for working in constricted areas. Self-mounting and dismounting via remote control available.
- 21t，详见配重组合表。配重可变量940mm，更适应狭窄场地作业。无线遥控实现配重自拆装。

Electrical system 电气系统

- 24V DC, two 12V battery sets connected in series.
- 直流24V，2个12V电池组串联。

Auxiliary boom nose 臂尖滑轮

- Fitted at boom head, used for single line operation. The maximum lifting load does not exceed 7.4t.
- 单滑轮，安装在主臂顶端，用于单股钢丝绳起重作业，起重性能与主臂相同，但最大起重重量不超过7.4t。

Crane Introduction

整机介绍

Carrier 下车

Optional equipment at extra fees 选配

- Engine: BENZ six cylinder OM471LA.E3A (EU Stage III), water cooled diesel Rated 360kW at 1700rpm. Torque 2300Nm at 1300rpm. Fuel reservoir capacity: 400L.
- Drive 8 × 8.
- Tires 8 tires sized 445/95 R 25 (16.00 R 25) or 525/80 R 25(20.5 R 25).
- 发动机: 奔驰 OM471LA.E3A 六缸水冷柴油发动机, 欧三, 额定功率 360kW/1700rpm, 最大扭矩 2300Nm/1300rpm, 油箱容积 400L。
- 驱动: 8 × 8。
- 轮胎: 8 个轮胎, 规格: 445/95R25 (16.00R25) 或 525/80R25 (20.5R25)。

Superstructure 上车

Optional equipment at extra fees 选配

- Engine: BENZ four cylinder OM 934 LA.E3A (EU Stage III), water cooled diesel. Rated 150kW at 2200rpm. Torque 800Nm at 1200rpm. Fuel reservoir capacity: 220L.
- TAJ Erection jib 2.9m.
- TF Single folding jib, 10.4m. Double swing-away jib 10.4m-18.7m. Mechanical adjustment 0°, 20°, 40°.
- THJ Hydraulically adjustable swing-away jib 10.4m-18.7m, Hydraulically adjustment 0°-40°.
- E Boom extension section 7m.
- Auxiliary hoist Axial piston variable displacement motor, SANY cable winch with integrated planetary gear and spring loaded retaining brake.
- Counterweight 5t × 2 for a total counterweight of 31t.
- 发动机: 奔驰 OM934LA.E3A 四缸水冷柴油发动机, 欧三, 额定功率 150kW/2200rpm, 最大扭矩 800Nm/1200rpm, 油箱容积 220L
- TAJ: 鹅头臂 2.9m
- TF: 机械变幅副臂, 单级 10.4m, 双级 10.4-18.7m, 变幅角度 0°、20°、40°。
- THJ: 液压折叠变幅副臂 10.8m-19m, 变幅角度 0°-40°。
- E: 主臂延伸节 7m。
- 副起升机构: 变量轴向柱塞马达, 带有与卷扬机结合成一体的行星驱动装置和弹簧抱闸制动器的三一钢丝绳卷扬机。
- 配重: 2 块各重 5 吨的附加配重, 使总配重达到 31 吨。

Working Conditions & Code Description

工况组合及工况代码说明

- T - Telescopic boom 主臂
- F - Fixed jib 固定副臂
- E - Boom extension 主臂延伸节
- AB - Auxiliary boom nose 臂尖滑轮
- AJ - Auxiliary jib 鹅头臂
- HJ - Hydraulically adjustable jib 液压变幅副臂



Operating Range-T

起升高度曲线 - 主臂

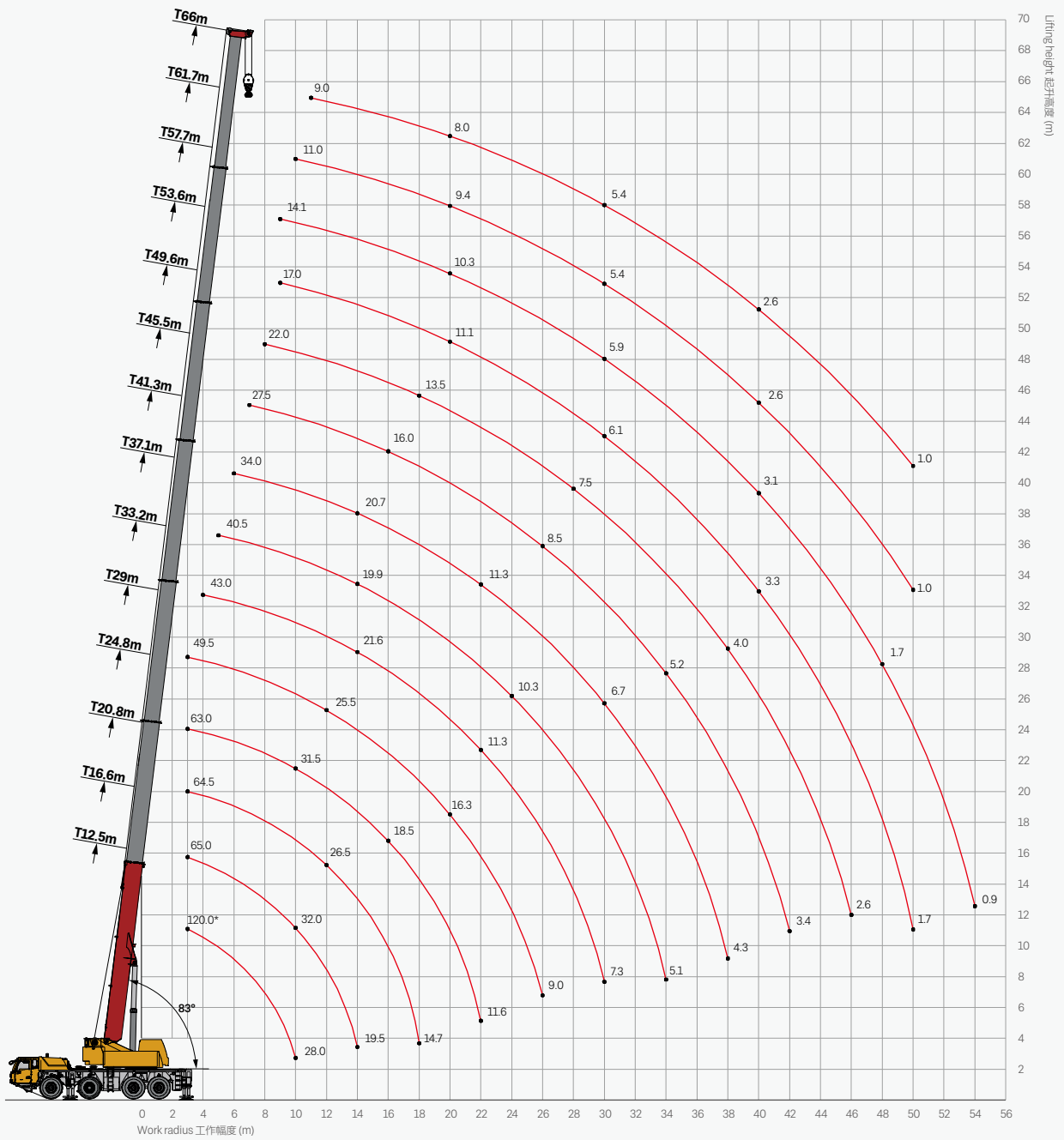

Load Chart-T

性能表 - 主臂

Unit: t

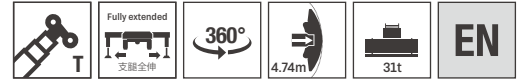

Radius (m) 幅度	12.5*	12.5	16.6	20.8	24.8	29	33.2	37.1	41.3	45.5	49.6	53.6	57.7	61.7	66	Radius (m) 幅度
3	120	70	65	64.5												3
3.5	76	70	65	64.3	63											3.5
4	70	67	63.5	63.5	61.5	49.5										4
4.5	65	62.5	60.5	57.5	57	49.5										4.5
5	60	58.5	56.2	54	52.5	49.5	43									5
6	53.5	51.5	50	47.9	46.5	43	43	40.5								6
7	47.5	46	45	43.5	42	40.3	39	37	34							7
8	42	41.3	40.5	39	38.5	37.2	35.7	34	32	27.5						8
9	36.4	36	36.1	36.5	34.4	33.5	32.6	30.3	29.9	26.3	22					9
10	28	28	32	32	31.5	31.3	30.3	27.5	27.8	24.7	20.3					10
11			29	29	28.5	29	27.8	26	26	23.1	19.4	17	14.1			11
12			25.8	26.5	26.5	25.8	26	25.4	24	21.7	18.3	16	14.1	11.2	9	12
14			19.5	21.7	21.5	21.5	21.6	19.9	20.7	18.4	16.5	15.1	13.2	11	8.8	14
16				18.2	18.5	18.7	18.2	17.3	16.4	16	16.3	13.7	12.3	10.8	8.6	16
18				14.7	15.5	16.1	15.5	15.2	15	14.2	13.5	12.4	11.3	10.2	8.3	18
20					13.7	13.6	13.2	12.8	13.1	11.8	11.9	11.1	10.3	9.4	8	20
22					11.6	11.8	11.2	11.6	11.2	10	10	10	9.4	8.8	7.6	22
24						10.2	9.5	10.2	9.6	9.2	9	9	8.7	7.8	7	24
26						9	8.8	8.9	8.3	8.5	8.3	8.3	7.7	7.2	6.5	26
28							8.2	7.7	7.4	7.5	7.5	7.3	6.9	6.3	6.1	28
30							7.1	6.5	6.7	6.7	6.5	6.1	5.9	5.4	5.4	30
32								5.9	6.2	6	5.7	5.5	5.1	4.6	4.6	32
34								5.1	5.5	5.2	5	4.8	4.4	4	4	34
36									4.6	4.6	4.4	4.3	3.8	3.5	3.5	36
38									4.3	4.1	4	3.8	3.5	3	3	38
40										3.7	3.5	3.3	3.1	2.6	2.6	40
42										3.4	3.2	2.9	2.7	2.2	2.3	42
44											2.9	2.6	2.3	1.8	1.9	44
46											2.6	2.2	1.9	1.5	1.5	46
48												1.9	1.6	1.2	1.2	48
50												1.5	1.3	0.9	0.9	50
52													1			52
54													0.8			54

Remark: rating with * indicates load over rear.

* 正后方吊载。

Load Chart-T

性能表 - 主臂

Unit: t

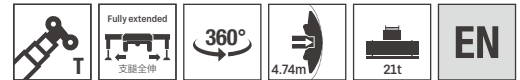

Radius (m) 幅度	12.5	16.6	20.8	24.8	29	33.2	37.1	41.3	45.5	49.6	53.6	57.7	61.7	66	Radius (m) 幅度
3	70	65	64.5												3
3.5	70	65	64.3	63											3.5
4	67	63.5	63.5	61.5	49.5										4
4.5	62.5	60.5	57.5	57	49.5										4.5
5	58.5	56.2	54	52.5	49.5	43									5
6	51.5	50	47.9	46.5	43	43	40.5								6
7	46	45	43.5	42	40.3	39	37	34							7
8	41	40.5	39	38.5	37.2	35.7	34	32	27.5						8
9	33.2	34	34.3	34.4	32.4	31.9	29.9	28	26.3	22					9
10	27.5	28.5	30	29.9	28.6	28.1	26.4	24.7	23.6	20.3					10
11		24.6	25.6	25.6	26.2	25	23.6	22	21	19.4	17	14.1			11
12		21.2	22.1	22.9	22.7	22.3	21.2	20.4	18.9	18.3	16	14.1	11.2	9	12
14		16.2	17.2	17.9	17.7	17.3	17.9	17.2	15.4	15	15.1	13.2	11	8.8	14
16			13.7	14.3	14.2	13.8	14.3	13.7	13	12.8	12.6	12.3	10.8	8.6	16
18			11.1	11.8	11.9	12.2	11.8	11.4	11.6	11.6	11.3	10.5	10.2	8.3	18
20				9.8	10	10.2	9.8	10	10.2	9.7	9.4	9.3	8.9	8	20
22				8.2	8.4	8.7	8.6	8.6	8.6	8.5	8.1	7.8	7.3	7.3	22
24					7.1	7.4	7.6	7.3	7.4	7.2	6.8	6.5	6	6	24
26					6	6.3	6.6	6.6	6.3	6.2	5.8	5.4	5	5	26
28						5.4	5.7	5.7	5.5	5.3	4.9	4.6	4.2	4.2	28
30						4.7	5	5	4.7	4.5	4.2	3.8	3.4	3.4	30
32							4.3	4.4	4.1	3.9	3.5	3.2	2.7	2.8	32
34							3.7	3.7	3.4	3.3	2.9	2.6	2.2	2.2	34
36								3.2	3	2.8	2.5	2.1	1.7	1.7	36
38								2.8	2.5	2.3	2	1.7	1.2	1.3	38
40									2.2	1.9	1.6	1.3	0.9	0.9	40
42									1.8	1.6	1.2	1	0.5	0.6	42
44										1.3	0.9	0.7			44
46										1	0.6				46
48															48
50															50
52															52
54															54

Load Chart-T

性能表 - 主臂

Unit: t

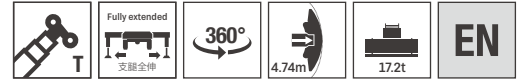

Radius (m) 幅度	12.5	16.6	20.8	24.8	29	33.2	37.1	41.3	45.5	49.6	53.6	57.7	61.7	66	Radius (m) 幅度
3	70	65	64.5												3
3.5	70	65	64.3	63											3.5
4	67	63.5	63.5	61.5	49.5										4
4.5	62.5	60.5	57.5	57	49.5										4.5
5	58.5	56.2	54	52.5	49.5	43									5
6	51.5	50	47.9	46.5	43	43	40.5								6
7	46	45	43.5	42	40.3	39	36.5	33.9							7
8	36	36.9	38.3	36.7	35	33.5	31.2	29.1	27.5						8
9	29	30.5	31.5	31.4	30.8	29	27.1	25.3	24.1	22					9
10	23.9	25.3	26.3	27.1	26.9	25.5	24	22.2	21.3	20.3					10
11		21.4	22.4	23.1	23	22.5	21.3	21.1	18.9	18.3	17	14.1			11
12		18.8	19.3	20.1	19.9	19.5	19.7	18.9	16.9	16.4	16	14.1	11.2	9	12
14		14.3	14.8	15.5	15.4	15.3	15.5	14.8	14.5	14	13.8	13.2	11	8.8	14
16			11.7	12.4	12.5	12.8	12.4	12.4	12.8	12.2	12	11.3	10.8	8.6	16
18			9.4	10.1	10.2	10.5	10.6	10.4	10.4	10.3	10	9.6	9.1	8.3	18
20				8.3	8.5	8.7	9	8.9	8.8	8.6	8.2	7.9	7.3	7.3	20
22				6.8	7	7.3	7.5	7.7	7.3	7.1	6.8	6.4	6	6	22
24					5.9	6.1	6.4	6.5	6.2	6	5.6	5.3	4.8	4.8	24
26					5	5.2	5.5	5.5	5.2	5.1	4.7	4.3	3.9	3.9	26
28						4.4	4.7	4.7	4.5	4.3	3.8	3.6	3.1	3.2	28
30						3.7	3.9	4	3.8	3.6	3.2	2.9	2.5	2.5	30
32							3.4	3.4	3.1	3	2.6	2.3	1.8	1.9	32
34							2.9	2.9	2.7	2.5	2.1	1.8	1.4	1.4	34
36								2.5	2.2	2	1.6	1.3	0.9	0.9	36
38								2.1	1.8	1.6	1.2	0.9	0.5	0.6	38
40									1.4	1.3	0.9	0.6			40
42									1.1	1	0.6				42
44										0.7					44

Load Chart-T

性能表 - 主臂

Unit: t

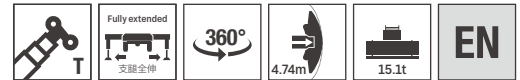

Radius (m) 幅度	12.5	16.6	20.8	24.8	29	33.2	37.1	41.3	45.5	49.6	53.6	57.7	61.7	66	Radius (m) 幅度
3	70	65	64.5												3
3.5	70	65	64.3	63											3.5
4	67	63.5	63.5	61.5	49.5										4
4.5	62.5	60.5	57.5	57	49.5										4.5
5	58.5	56.2	54	52.5	49.5	43									5
6	51.5	50	47.9	46.5	43	43	40.5								6
7	42.9	43.9	43	41.2	39.5	37.1	34.5	32							7
8	33.3	34.8	35.5	34.7	33.7	31.6	29.5	27.4	26.1						8
9	26.7	28.1	29.2	30	29.2	27.4	25.8	24	22.7	21.9					9
10	21.9	23.3	24.3	25.1	25	24.1	22.6	22	19.9	19.3					10
11		20.1	20.7	21.3	21.2	20.7	20.5	19.8	17.7	17.1	17	14.1			11
12		17.2	17.8	18.5	18.3	17.9	18.5	17.8	16	15.5	15.3	14.1	11.2	9	12
14		13	13.6	14.3	14.3	14.7	14.3	14.3	14.1	14	13.5	12.3	11	8.8	14
16			11	11.3	11.5	11.8	11.9	11.7	11.7	11.6	11.2	10.8	10.1	8.6	16
18			8.4	9.1	9.3	9.6	9.9	9.9	9.6	9.4	9	8.7	8.2	8.2	18
20				7.4	7.6	7.9	8.2	8.3	7.9	7.7	7.3	7	6.5	6.6	20
22				6.1	6.2	6.5	6.8	6.9	6.6	6.4	6	5.7	5.2	5.2	22
24					5.2	5.5	5.7	5.8	5.5	5.3	4.9	4.6	4.1	4.2	24
26					4.3	4.6	4.9	4.9	4.6	4.4	4.1	3.7	3.3	3.3	26
28						3.8	4.1	4.1	3.9	3.6	3.3	3	2.5	2.5	28
30						3.1	3.5	3.5	3.2	3	2.7	2.4	1.9	1.9	30
32							2.9	3	2.7	2.5	2.1	1.8	1.4	1.4	32
34							2.4	2.5	2.2	2	1.6	1.3	0.9	0.9	34
36								2	1.8	1.6	1.2	0.9	0.5	0.5	36
38								1.7	1.4	1.2	0.9	0.6			38
40									1.1	0.9	0.5				40
42									0.8	0.6					42

Load Chart-T

性能表 - 主臂

Unit: t

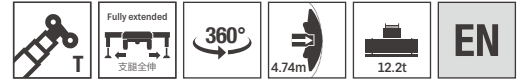

Radius (m) 幅度	12.5	16.6	20.8	24.8	29	33.2	37.1	41.3	45.5	49.6	53.6	57.7	61.7	66	Radius (m) 幅度
3	70	65	64.5												3
3.5	70	65	64.3	63											3.5
4	67	63.5	63.5	61.5	49.5										4
4.5	62.5	60.5	57.5	57	49.5										4.5
5	58.5	56.2	54	52.5	49.5	43									5
6	51.5	50	47.9	46	42.6	41.1	37.9								6
7	38.2	39.2	40.1	38	36.7	34.2	31.7	29.4							7
8	29.4	30.9	32.1	32.9	31.1	29.2	27.1	25.1	23.8						8
9	23.5	24.9	26	26.8	26.6	25.2	23.6	23.2	20.7	19.9					9
10	19.1	21	21.6	22.4	22.2	21.7	21	20.4	18.1	17.5					10
11		17.7	18.2	19	18.8	18.3	19	18.5	17	16	15.7	14.1			11
12		15	15.6	16.3	16.2	16.7	16.3	16.3	16	15.5	14.8	13.4	11.2	9	12
14		11.3	12.1	12.5	12.7	13	13.3	12.8	12.9	12.8	12.3	11.6	10.8	8.8	14
16			9.5	9.8	9.9	10.3	10.6	10.6	10.3	10.1	9.7	9.4	8.8	8.6	16
18			7.1	7.8	8	8.3	8.6	8.6	8.3	8.1	7.6	7.3	6.8	6.9	18
20				6.3	6.4	6.7	7	7.1	6.8	6.5	6.2	5.8	5.4	5.4	20
22				5	5.2	5.5	5.8	5.8	5.6	5.4	5	4.7	4.2	4.2	22
24					4.3	4.6	4.8	4.8	4.6	4.4	3.9	3.7	3.2	3.2	24
26					3.4	3.7	4	4	3.7	3.6	3.2	2.9	2.4	2.5	26
28						3.1	3.3	3.3	3.1	2.9	2.5	2.2	1.8	1.8	28
30						2.5	2.7	2.8	2.5	2.3	1.9	1.6	1.2	1.2	30
32							2.2	2.3	2	1.8	1.5	1.1	0.7	0.7	32
34							1.8	1.8	1.5	1.4	1	0.7			34
36								1.4	1.2	1	0.6				36
38								1.1	0.8	0.7					38
40									0.5						40

Load Chart-T

性能表 - 主臂

Unit: t

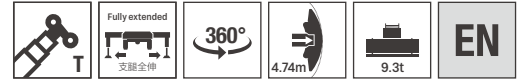

Radius (m) 幅度	12.5	16.6	20.8	24.8	29	33.2	37.1	41.3	45.5	49.6	53.6	57.7	61.7	66	Radius (m) 幅度
3	70	65	64.5												3
3.5	70	65	64.3	63											3.5
4	67	63.5	63.5	61.5	49.5										4
4.5	62.5	60.5	57.5	57	49.5										4.5
5	58.5	56.2	54	52.5	49	43									5
6	46.3	47.3	45.4	42.6	40.7	37.7	34.8								6
7	33.5	35.2	36.4	35.8	33.7	31.4	29	26.8							7
8	25.6	27.1	28.3	29.1	28.5	26.7	24.9	24	21.6						8
9	20.3	22.1	22.8	23.6	23.4	22.9	21.7	21.1	19.2	18					9
10	16.3	18.2	18.8	19.6	19.4	18.9	19.6	19.2	18	17					10
11		15.2	15.8	16.6	16.4	17.1	16.9	16.6	16.5	15.6	14.7	13.9			11
12		12.9	13.9	14.1	14.3	14.7	15	14.8	14.7	14.4	13.4	12.6	11.2	9	12
14		9.5	10.5	10.7	10.9	11.2	11.5	11.5	11.3	11	10.6	10.2	9.4	8.8	14
16			8	8.3	8.4	8.7	9	9.1	8.8	8.6	8.2	7.8	7.3	7.4	16
18			5.8	6.5	6.7	6.9	7.3	7.3	7	6.8	6.4	6	5.6	5.6	18
20				5.2	5.3	5.6	5.8	5.9	5.6	5.4	5	4.7	4.2	4.3	20
22				4	4.2	4.5	4.8	4.9	4.5	4.3	3.9	3.6	3.2	3.2	22
24					3.3	3.5	3.9	3.9	3.6	3.4	3	2.7	2.3	2.3	24
26					2.6	2.8	3.1	3.2	2.9	2.7	2.3	2	1.6	1.6	26
28						2.3	2.5	2.6	2.3	2.1	1.7	1.4	1	1	28
30						1.7	2	2.1	1.8	1.6	1.2	0.9	0.5	0.5	30
32							1.5	1.6	1.3	1.1	0.8	0.5			32
34							1.1	1.2	0.9	0.7					34
36								0.8	0.6						36
38								0.6							38

Load Chart-T

性能表 - 主臂

Unit: t

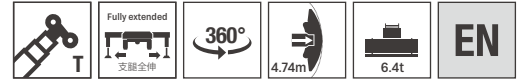

Radius (m) 幅度	12.5	16.6	20.8	24.8	29	33.2	37.1	41.3	45.5	49.6	53.6	57.7	61.7	66	Radius (m) 幅度
3	70	65	64.5												3
3.5	70	65	64.3	63											3.5
4	67	63.5	63.5	61.5	49.5										4
4.5	62.5	60.5	57.5	56.3	49.5										4.5
5	58.5	56.2	53	49	44.7	42.7									5
6	40.1	41.9	41.4	39.9	37.2	34.4	31.6								6
7	28.7	30.4	31.7	32.6	30.7	28.5	26.5	24.1							7
8	21.8	23.8	24.4	25.3	25.1	24.2	22.5	21.9	20						8
9	17	19	19.6	20.4	20.2	19.7	20.4	19.5	18.6	17.7					9
10	13.6	15.5	16.6	16.8	16.7	17.4	17.8	17.2	16.8	16					10
11		12.8	13.8	14.1	14.3	14.7	15	15	14.7	14.2	13.2	12.4			11
12		10.8	11.7	12	12.2	12.6	12.9	13	12.6	12.3	11.7	11	10.1	9	12
14		7.7	8.7	8.9	9.1	9.4	9.7	9.8	9.5	9.3	8.8	8.5	8	7.7	14
16			6.5	6.8	7	7.3	7.5	7.6	7.2	7	6.6	6.3	5.8	5.8	16
18			4.5	5.2	5.4	5.7	6	6	5.7	5.5	5.1	4.7	4.3	4.3	18
20				3.9	4.2	4.4	4.7	4.8	4.5	4.3	3.9	3.5	3	3.1	20
22				3	3.2	3.4	3.8	3.8	3.5	3.3	2.9	2.6	2.1	2.1	22
24					2.4	2.7	2.9	3	2.7	2.5	2.1	1.8	1.3	1.3	24
26					1.7	1.9	2.3	2.3	2.1	1.9	1.4	1.2	0.7	0.7	26
28						1.4	1.7	1.8	1.5	1.3	0.9	0.6			28
30						1	1.3	1.3	1	0.8	0.5				30
32							0.9	0.9	0.6	0.5					32
34							0.5	0.6							34

Load Chart-T

性能表 - 主臂

Unit: t

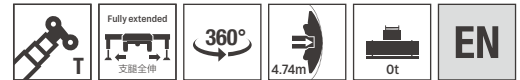

Radius (m) 幅度	12.5	16.6	20.8	24.8	29	33.2	37.1	41.3	45.5	49.6	53.6	57.7	61.7	66	Radius (m) 幅度
3	70	65	64.5												3
3.5	70	65	64.3	63											3.5
4	67	63.5	58.9	52.7	47										4
4.5	56.1	53.2	49.4	46.5	42.3										4.5
5	41.7	44.1	42.9	40.4	37.1	33.8									5
6	26.3	28.8	29.6	30.8	29.4	26.8	24.3								6
7	18.3	20.5	21.8	22.2	22	21.5	21	19.8							7
8	13.4	15.4	16.6	16.9	17.1	17.6	18	17	16.4						8
9	10	11.9	13	13.3	13.5	13.9	14.3	14.4	13.9	13.2					9
10	7.5	9.4	10.4	10.7	10.9	11.3	11.7	11.7	11.4	11.1					10
11		7.5	8.5	8.8	9	9.3	9.7	9.7	9.4	9.2	8.7	8.3			11
12		6	6.9	7.3	7.4	7.8	8.1	8.2	7.8	7.6	7.1	6.8	6.2	6.2	12
14		3.8	4.7	5	5.2	5.5	5.8	5.9	5.6	5.4	4.9	4.5	4	4	14
16			3.2	3.4	3.6	3.9	4.2	4.3	4	3.8	3.3	3	2.5	2.5	16
18			1.6	2.3	2.5	2.8	3.1	3.1	2.8	2.6	2.2	1.8	1.4	1.4	18
20				1.4	1.5	1.8	2.2	2.2	1.9	1.7	1.3	1	0.5	0.6	20
22				0.7	0.9	1.2	1.4	1.5	1.2	1	0.7				22
24						0.6	0.9	0.9	0.7	0.5					24
26								0.5							26

Load Chart-T(AB)

性能表 - 主臂

Unit: t



Radius (m) 幅度	12.5	16.4	20.3	24.5	28.5	32.6	36.8	40.8	45	49.1	53.3	57.5	61.7	66	Radius (m) 幅度
3	7.4	7.4	7.4	7.4	7.4										3
3.5	7.4	7.4	7.4	7.4	7.4										3.5
4	7.4	7.4	7.4	7.4	7.4	7.4									4
4.5	7.4	7.4	7.4	7.4	7.4	7.4									4.5
5	7.4	7.4	7.4	7.4	7.4	7.4	7.4								5
6	7.4	7.4	7.4	7.4	7.4	7.4	7.4	7.4							6
7	7.4	7.4	7.4	7.4	7.4	7.4	7.4	7.4	7.4						7
8	7.4	7.4	7.4	7.4	7.4	7.4	7.4	7.4	7.4	7.4					8
9	7.4	7.4	7.4	7.4	7.4	7.4	7.4	7.4	7.4	7.4	7.4				9
10	7.4	7.4	7.4	7.4	7.4	7.4	7.4	7.4	7.4	7.4	7.4	7.4			10
11		7.4	7.4	7.4	7.4	7.4	7.4	7.4	7.4	7.4	7.4	7.4	7.4	7.4	11
12		7.4	7.4	7.4	7.4	7.4	7.4	7.4	7.4	7.4	7.4	7.4	7.4	7.4	12
14		7.4	7.4	7.4	7.4	7.4	7.4	7.4	7.4	7.4	7.4	7.4	7.4	7.4	14
16			7.4	7.4	7.4	7.4	7.4	7.4	7.4	7.4	7.4	7.4	7.4	7.4	16
18			7.4	7.4	7.4	7.4	7.4	7.4	7.4	7.4	7.4	7.4	7.4	7.4	18
20				7.4	7.4	7.4	7.4	7.4	7.4	7.4	7.4	7.4	7.4	7.4	20
22				7.4	7.4	7.4	7.4	7.4	7.4	7.4	7.4	7.4	7.4	7.4	22
24					7.4	7.4	7.4	7.4	7.4	7.4	7.4	7.4	7.4	6.9	24
26					7.4	7.4	7.4	7.4	7.4	7.4	7.4	7.4	7.2	6.4	26
28						7.4	7.4	7.4	7.4	7.4	7.2	6.8	6.2	6	28
30							7	7	6.8	6.6	6.3	6	5.8	5.4	30
32								6.2	6.1	5.9	5.6	5.4	5	4.5	32
34								5.5	5.4	5.1	4.9	4.7	4.3	3.9	34
36									4.9	4.5	4.3	4.2	3.7	3.4	36
38									4.4	4	3.9	3.7	3.4	2.9	38
40										3.6	3.4	3.2	3	2.5	40
42											3.3	3.1	2.8	2.6	42
44												2.8	2.5	2.3	44
46													2.5	2.2	46
48														1.8	48
50															50
52															52
54															54

Load Chart-TF / THJ

性能表 - 副臂

Unit: t



Radius 幅度 (m)	57.8			57.5			61.7			65.3			Radius 幅度 (m)
	10.4			10.4			10.4			10.4			
	0°	20°	40°	0°	20°	40°	0°	20°	40°	0°	20°	40°	
11	7.2			6									11
12	7.2			6			5.6						12
13	7.1			6			5.6						13
14	7.1	7		6	6		5.6			4.4			14
16	6.9	6.9		6	5.9		5.5	5.5		4.4	4.5		16
18	6.8	6.8	6.6	5.9	5.8	5.7	5.5	5.4		4.3	4.4		18
20	6.6	6.7	6.6	5.7	5.6	5.6	5.4	5.3	5.3	4.3	4.3	4.3	20
22	6.4	6.6	6.6	5.5	5.4	5.3	5.3	5.2	5.3	4.2	4.2	4.3	22
24	6.1	6.6	6.5	5.3	5.1	5.1	5.1	5.1	5.1	4.1	4.1	4.2	24
26	5.4	6.3	6.3	5.1	5	4.9	5	4.9	4.9	4	4	4	26
28	4.7	5.6	5.9	4.8	4.7	4.7	4.8	4.8	4.8	3.8	3.8	3.9	28
30	3.9	4.8	5.2	4.6	4.6	4.4	4.5	4.6	4.6	3.7	3.7	3.8	30
32	3.3	4	4.6	4.3	4.3	4.5	3.9	4.2	4.4	3.5	3.6	3.7	32
34	2.9	3.3	3.8	3.7	4.1	4.2	3.3	3.7	4	3.1	3.5	3.6	34
36	2.5	2.9	3.2	3.2	3.5	3.7	2.9	3.2	3.5	2.7	3	3.3	36
38	2.1	2.5	2.7	2.8	3.1	3.3	2.5	2.8	3	2.3	2.7	2.8	38
40	1.7	2.2	2.3	2.5	2.8	2.8	2.1	2.4	2.6	1.9	2.3	2.5	40
42	1.4	1.8	2	2.2	2.4	2.6	1.8	2.1	2.3	1.6	1.9	2.1	42
44	1.1	1.4	1.6	1.9	2.1	2.2	1.4	1.7	1.9	1.3	1.5	1.8	44
46	0.9	1.1	1.3	1.5	1.8	1.9	1.1	1.4	1.6		1.2	1.4	46
48		0.8	1	1.2	1.5	1.6	0.9	1.1	1.2			1.1	48
50				1	1.1	1.3		0.9	1				50
52					1	1							52

Load Chart-TF / THJ

性能表 - 副臂

Unit: t



Radius 幅度 (m)	49.6			49.2			53.8			57.8			61.7			65.3			Radius 幅度 (m)
	18.7			18.7			18.7			18.7			18.7			18.7			
	0°	20°	40°	0°	20°	40°	0°	20°	40°	0°	20°	40°	0°	20°	40°	0°	20°	40°	
11	5.1																		11
12	5.1			4															12
13	5.1			3.9															13
14	5.1			3.9			3.8			3.5			3.3			2.7			14
16	4.9	4		3.9			3.7			3.5			3.3			2.7			16
18	4.8	3.8		3.8	3.3		3.7	3.4		3.4			3.2			2.7			18
20	4.6	3.7		3.8	3.2		3.6	3.3		3.4	3.2		3.1	2.9		2.7			20
22	4.4	3.6	3	3.7	3.2	2.7	3.6	3.2		3.4	3.2		3.1	2.9		2.7	2.6		22
24	4.2	3.5	3	3.6	3.1	2.7	3.5	3.2	2.8	3.3	3.1	2.7	3	2.9		2.6	2.5		24
26	4	3.4	2.9	3.5	3	2.7	3.4	3.1	2.7	3.3	3	2.7	3	2.9	2.8	2.6	2.5		26
28	4	3.3	2.9	3.4	2.9	2.7	3.4	3	2.7	3.2	3	2.7	2.9	2.9	2.7	2.5	2.5	2.5	28
30	3.9	3.2	2.9	3.3	2.9	2.7	3.4	3	2.7	3.2	2.9	2.7	2.9	2.9	2.7	2.5	2.5	2.5	30
32	3.7	3.1	2.9	3.2	2.8	2.7	3.3	2.9	2.7	3.2	2.9	2.7	2.9	2.9	2.7	2.4	2.5	2.5	32
34	3.3	3.1	2.9	3.2	2.8	2.7	3.2	2.9	2.7	3.1	2.8	2.7	2.9	2.9	2.7	2.4	2.5	2.5	34
36	2.8	3	2.9	3.2	2.7	2.7	3.1	2.8	2.7	3.1	2.8	2.7	2.8	2.8	2.7	2.4	2.5	2.5	36
38	2.5	2.9	2.9	3.2	2.7	2.6	3	2.8	2.7	2.7	2.8	2.7	2.4	2.8	2.7	2.2	2.5	2.5	38
40	2.1	2.6	2.7	3	2.6	2.6	2.7	2.7	2.7	2.5	2.7	2.7	2.1	2.5	2.7	2	2.4	2.5	40
42	1.8	2.2	2.5	2.7	2.6	2.6	2.4	2.7	2.7	2.2	2.6	2.7	1.8	2.2	2.6	1.6	2.1	2.4	42
44	1.5	1.9	2.1	2.4	2.5	2.6	2.1	2.5	2.7	1.9	2.2	2.5	1.5	2	2.3	1.3	1.8	2.2	44
46	1.1	1.6	1.9	2.2	2.4	2.5	1.9	2.2	2.4	1.6	1.9	2.2	1.2	1.6	2	1.1	1.5	1.9	46
48	0.9	1.2	1.5	2	2.2	2.3	1.7	1.9	2.1	1.3	1.7	1.9	1	1.3	1.7		1.2	1.6	48
50		1	1.2	1.7	2	2.1	1.4	1.7	1.9	1.1	1.5	1.7		1.1	1.4			1.3	50
52		0.7	0.9	1.5	1.7	1.9	1.1	1.5	1.6	0.9	1.2	1.4			1.2			1.1	52
54				1.3	1.5	1.6	1	1.2	1.4		1	1.2			0.9				54
56				1.1	1.3		0.8	1	1.1		0.8	1							56
58				0.9	1.1			0.8											58
60				0.6	0.8														60

Load Chart-TEF / TEHJ

性能表 - 主臂延伸节 + 副臂

Unit: t



Radius 幅度 (m)	53.8			53.3			57.8			61.7			65.3			Radius 幅度 (m)
	17.4			17.4			17.4			17.4			17.4			
	0°	20°	40°	0°	20°	40°	0°	20°	40°	0°	20°	40°	0°	20°	40°	
10	6			4.7												10
11	6			4.7			4.2									11
12	5.9			4.7			4.2			3.9						12
13	5.9			4.6			4.2			3.9						13
14	5.9			4.6			4.2			3.9			3.2			14
16	5.8	5.7		4.5	4.4		4.2	4.2		3.9			3.2			16
18	5.7	5.7	5	4.4	4.3	4.1	4.1	4.1		3.8	3.8		3.2	3.2		18
20	5.5	5.5	5	4.3	4.2	4.1	4	4	3.9	3.8	3.8	3.6	3.1	3.2		20
22	5.4	5.4	5	4.2	4.1	4	3.9	3.8	3.8	3.8	3.7	3.6	3.1	3.1	3.1	22
24	5.2	5.2	4.8	4.1	3.9	3.9	3.8	3.7	3.7	3.7	3.6	3.6	3	3.1	3.1	24
26	5.1	5	4.7	3.9	3.8	3.7	3.7	3.6	3.6	3.6	3.6	3.6	3	3	3	26
28	4.7	4.9	4.5	3.7	3.6	3.6	3.5	3.5	3.5	3.5	3.5	3.5	2.9	2.9	3	28
30	4.1	4.7	4.4	3.5	3.5	3.4	3.4	3.4	3.3	3.4	3.4	3.4	2.8	2.8	2.9	30
32	3.4	4.1	4.2	3.4	3.3	3.3	3.3	3.2	3.2	3.3	3.3	3.3	2.8	2.8	2.8	32
34	2.9	3.5	3.6	3.2	3.2	3.2	3.2	3.2	3.2	3	3.2	3.2	2.8	2.8	2.8	34
36	2.4	2.9	3.2	3	3.1	3.1	3.1	3.1	3.1	2.7	3	3	2.5	2.7	2.7	36
38	2.1	2.6	2.7	2.8	3	3	2.8	2.9	3	2.3	2.6	2.8	2.1	2.4	2.6	38
40	1.6	2.1	2.2	2.7	2.8	2.8	2.4	2.7	2.8	1.9	2.2	2.5	1.7	2.1	2.4	40
42	1.4	1.7	1.8	2.3	2.6	2.6	2	2.3	2.5	1.5	1.8	2.1	1.4	1.7	2	42
44	1	1.4	1.5	2	2.2	2.4	1.7	1.9	2.1	1.2	1.5	1.7	1.1	1.4	1.6	44
46	0.8	1.1	1.2	1.7	1.9	2.1	1.4	1.6	1.8	1	1.2	1.4		1.1	1.3	46
48		0.7	0.9	1.5	1.7	1.8	1.1	1.3	1.5		1	1.1			1	48
50				1.2	1.4	1.5	0.9	1.1	1.2			0.9				50
52				1	1.1	1.2		0.9	1							52
54					0.9	1										54

Load Chart-TEF / TEHJ

性能表 - 主臂延伸节 + 副臂

Unit: t



Radius 幅度 (m)	49.6			49.2			53.8			57.8			61.7			65.3			Radius 幅度 (m)
	25.7			25.7			25.7			25.7			25.7			25.7			
	0°	20°	40°	0°	20°	40°	0°	20°	40°	0°	20°	40°	0°	20°	40°	0°	20°	40°	
12							3			2.7									12
13							3			2.7									13
14	4.3			3.1			3			2.7			2.4			1.8			14
16	4.3			3			3			2.7			2.4			1.8			16
18	4.2	3.8		2.9			2.9			2.7			2.4			1.8			18
20	4.1	3.7		2.8	2.7		2.8	2.6		2.7	2.5		2.4			1.8			20
22	4	3.6		2.7	2.7		2.7	2.6		2.6	2.4		2.4	2.4		1.8			22
24	3.9	3.5	3	2.7	2.6	2.4	2.7	2.6		2.5	2.4		2.4	2.4		1.8	1.9		24
26	3.9	3.4	3	2.7	2.6	2.4	2.6	2.6	2.3	2.5	2.4	2.3	2.4	2.4		1.8	1.9		26
28	3.8	3.4	3	2.6	2.5	2.4	2.6	2.5	2.4	2.5	2.4	2.3	2.4	2.3	2.3	1.8	1.9	1.8	28
30	3.6	3.3	2.9	2.6	2.4	2.3	2.6	2.5	2.4	2.4	2.4	2.3	2.4	2.3	2.3	1.8	1.9	1.8	30
32	3.5	3.2	2.9	2.5	2.3	2.3	2.5	2.5	2.4	2.4	2.4	2.3	2.3	2.3	2.3	1.8	1.9	1.8	32
34	3.3	3.1	2.9	2.4	2.3	2.2	2.5	2.4	2.4	2.4	2.4	2.3	2.3	2.3	2.3	1.8	1.9	1.8	34
36	2.9	3.1	2.9	2.3	2.2	2.2	2.4	2.4	2.3	2.3	2.3	2.3	2.3	2.3	2.3	1.8	1.9	1.8	36
38	2.5	3	2.8	2.3	2.2	2.1	2.4	2.3	2.3	2.3	2.3	2.2	2.2	2.3	2.3	1.8	1.9	1.8	38
40	2.1	2.7	2.8	2.2	2.1	2	2.3	2.3	2.2	2.2	2.2	2.2	1.9	2.3	2.3	1.8	1.9	1.8	40
42	1.8	2.3	2.7	2	2	2	2.2	2.2	2.1	1.9	2.1	2.1	1.6	2.1	2.3	1.6	1.9	1.8	42
44	1.4	2	2.3	1.9	1.9	1.9	2	2.1	2.1	1.6	2	2.1	1.3	1.8	2.1		1.7	1.8	44
46	1.1	1.6	2	1.9	1.9	1.9	1.7	2	2	1.4	1.8	2	1	1.5	1.9		1.4	1.7	46
48	0.8	1.3	1.7	1.6	1.8	1.9	1.5	1.8	1.9	1.1	1.5	1.9		1.2	1.6		1.1	1.4	48
50		1	1.3	1.5	1.7	1.8	1.2	1.6	1.7		1.2	1.6			1.3			1.1	50
52		0.8	1	1.2	1.5	1.6	1	1.3	1.6		1.1	1.3			1				52
54				1	1.3	1.5		1.1	1.3			1.1							54
56				0.9	1.1	1.2		1	1.1			0.9							56
58				0.9	1				0.9										58
60				0.7															60
62																			62

Operating Range-TAJ

起升高度曲线 - 鹅头臂

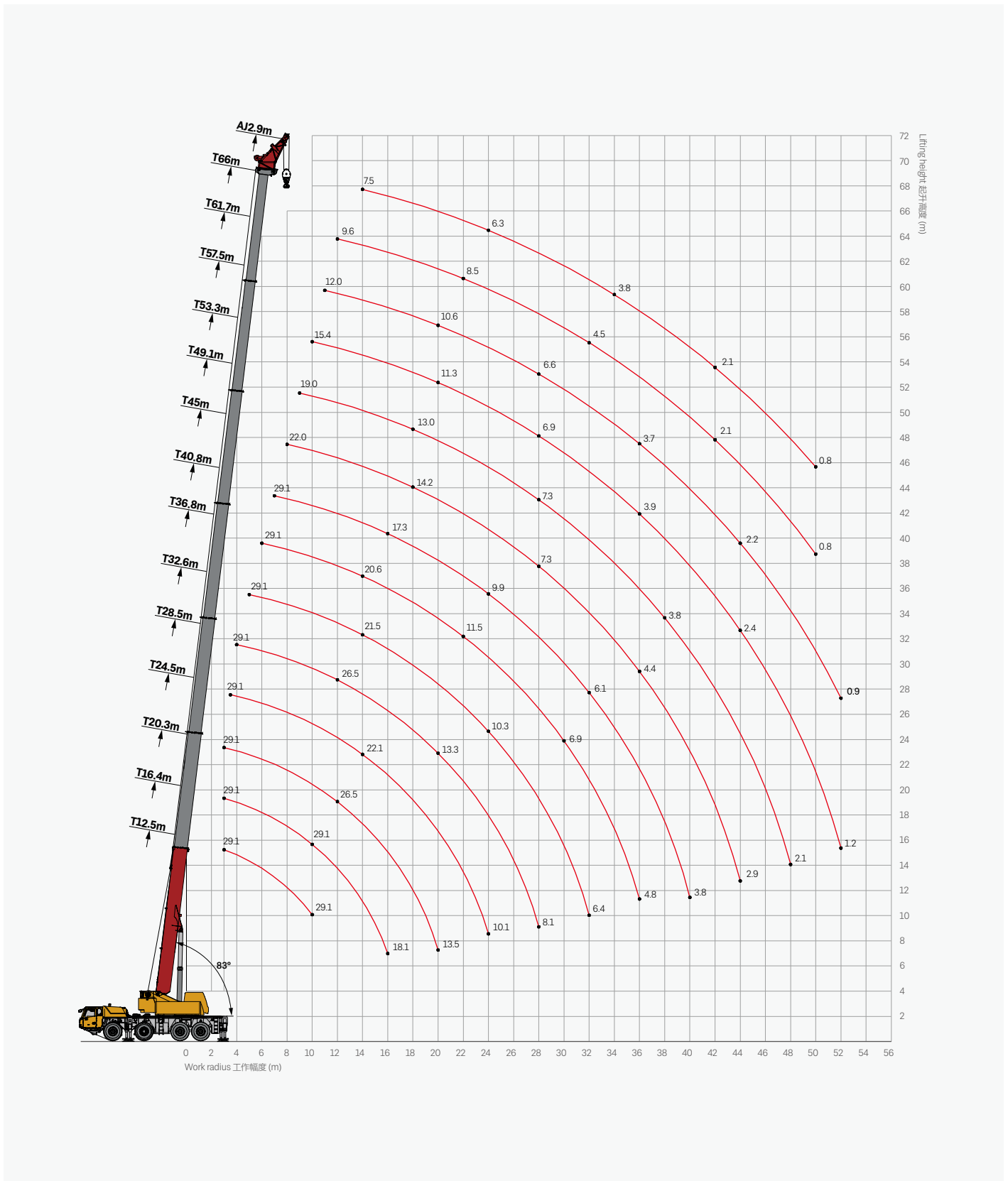

Load Chart-TAJ

性能表 - 鹅头臂

Unit: t



Radius 幅度 (m)	12.5	16.4	20.3	24.5	28.5	32.6	36.8	40.8	45	49.1	53.3	57.5	61.7	66	Radius 幅度 (m)
	2.9m														
3	29.1	29.1	29.1												3
3.5	29.1	29.1	29.1	29.1											3.5
4	29.1	29.1	29.1	29.1	29.1										4
4.5	29.1	29.1	29.1	29.1	29.1										4.5
5	29.1	29.1	29.1	29.1	29.1	29.1									5
6	29.1	29.1	29.1	29.1	29.1	29.1	29.1								6
7	29.1	29.1	29.1	29.1	29.1	29.1	29.1	29.1							7
8	29.1	29.1	29.1	29.1	29.1	29.1	29.1	29.1	22						8
9	29.1	29.1	29.1	29.1	29.1	29.1	29.1	29.1	22	19					9
10	29.1	29.1	29.1	29.1	29.1	28.9	27.6	26.2	22	18.5	15.4				10
11		28.9	29	28.8	28.3	27.3	25.7	20	22	17	15.3	12			11
12		26.2	26.5	26.9	26.5	25.3	24	18.4	21.3	17	15.1	11.9	9.6		12
14		21.4	22	22.1	21.9	21.5	20.6	19.6	18.9	16	14.7	11.7	9.5	7.5	14
16		18.1	18.5	18.5	18.3	18	17.5	17.3	16.4	14.5	14.2	11.4	9.3	7.4	16
18			15.7	15.7	15.6	15.3	15.5	14.8	14.2	13	12.8	11.1	9.1	7.2	18
20			13.5	13.5	13.3	13.7	13.3	13.1	12.4	11.6	11.3	10.6	8.8	6.9	20
22				11.7	12	11.9	11.5	11.3	11.1	10.7	10.1	9.4	8.5	6.6	22
24				10.1	10.5	10.3	9.9	9.9	9.8	9.4	8.8	8.4	8	6.3	24
26					9.2	8.9	8.8	8.6	8.5	8.1	8	7.6	7	6	26
28					8.1	7.8	7.9	7.6	7.3	7.3	6.9	6.6	6.1	5.6	28
30						6.9	6.9	6.7	6.6	6.3	6	5.7	5.2	5.1	30
32						6.4	6.1	6.1	5.8	5.5	5.1	4.9	4.5	4.4	32
34							5.4	5.4	5.1	4.8	4.4	4.2	3.9	3.8	34
36							4.8	4.7	4.4	4.2	3.9	3.7	3.3	3.3	36
38								4.2	4	3.8	3.5	3.2	2.9	2.9	38
40								3.8	3.6	3.4	3.1	2.8	2.5	2.4	40
42									3.2	3	2.7	2.5	2.1	2.1	42
44									2.9	2.7	2.4	2.2	1.8	1.7	44
46										2.4	2.1	1.8	1.4	1.4	46
48										2.1	1.8	1.5	1.1	1.1	48
50											1.5	1.2	0.8	0.8	50
52											1.2	0.9			52

Remark

- The lifting capacities correspond to EN 13000.
- The lifting capacities likewise fulfil the requirements of ISO 4305 with regard to stability.
- Depending on the boom length, max. wind speeds between 7m/s and 15m/s are permissible in the load charts.
- Lifting capacities are given in metric tons.
- The working radius is the horizontal gravity center distance of the load from the slewing axis of the crane superstructure measured at the ground. The radius stated is valid under load conditions, i.e. including boom deflection.
- Boom positions differing from those given in the load capacity tables are not permissible.
- The boom may only be manoeuvred into those areas specified in the load chart, even if empty load is suspended, otherwise there is a risk of the crane tilting.
- The total rated loads given in the rated load charts are the maximum lifting capacity when the crane is set up on firm and level ground, which includes the weight of the hook block and slings. The weight of above-mentioned devices should be deducted to correctly calculate the load weight.

- 起重性能符合 EN13000。
- 起重性能同样满足 ISO4305 关于稳定性的要求。
- 根据臂长，起重性能允许的最大风速介于 7m/s 和 15m/s 之间。
- 起重性能以公吨为单位。
- 工作半径是指从上车回转轴到货物重心的在地面测量的水平距离。半径在吊载货物的情况下是有效的，已包括主臂挠度。
- 与性能表中不一致的臂长设置是不允许的。
- 主臂操作只允许在工况注明的范围内进行，包括空载，否则有倾翻的危险。
- 表中额定总起重重量值，是在平整的坚固地面上本起重机能保证的最大总起重重量，包括吊钩和吊具的重量，为了估算重物重量，必须减去上述的装置重量。

Icon Description

图标说明



Max. lifting capacity
最大起重量



Max. boom length
最大主臂长



Max. lifting radius
最大吊载幅度



Max. lifting height
最大吊载高度



Driver's cab
驾驶室



Carrier frame
车架



Engine
发动机



Transmission
变速箱



Transfer case
分动箱



Axle
车桥



Outrigger
支腿



Slewing platform
转台



Crane control
操纵方式



Hoist
起升机构



Suspension system
悬挂



Steering
转向



Tires
轮胎



Wheel formula
轮胎模式



Brake
制动



Electrical system
电气系统



Hydraulic system
液压系统



Slewing mechanism
回转机构



Safety equipment
安全装置



Load moment indicator
力矩限制器



Counterweight
配重



Boom & telescoping system
主臂



Auxiliary boom nose
臂尖滑轮



CW backward positioned
配重后移



SANY GROUP CRANE BU

SANY Mobile Crane Industrial Park, No.168 Jinzhou Avenue, Jinzhou Development Zone, Changsha City,
Hunan Province, P.R. China Zip 410600
Consulting sanycrane@sanygroup.com (Crane BU) / crd@sany.com.cn (IHQ)
After-sales Service 0086-400 6098 318

Reminder:

Any change in the technical parameters and configuration due to product modification or upgrade may occur without prior notice.
The machine in the picture may include additional equipment. This brochure is for reference only, and goods in kind shall prevail.
Copyright at SANY. No part of this brochure may be copied or used for any purpose without written approval from SANY.

© Edited in June 2022

三一集团起重事业部

中国湖南长沙金洲开发区金洲大道 168 号 三一汽车起重机产业园 邮编: 410600
咨询: sanycrane@sanygroup.com (起重事业部) / crd@sany.com.cn (国际总部)
海外售后服务: 0086-400 6098 318

温馨提示:

由于技术不断更新, 技术参数及配置如有更改, 恕不另行通知。图中机器可能包括附加设备, 本画册仅供参考, 以实物为准。
版权为三一所有, 未经三一书面许可, 本画册任何内容不得被复制用于任何目的。

© 2022 年 6 月版

